

The applicability of geoelectrical methods in pre-investigation for construction in rock

Berit Ensted Danielsen

**Engineering Geology
Lund University**

**Doctoral Thesis
2010**



LUND UNIVERSITY

Author

Berit Ensted Danielsen 1978-

Title

The applicability of geoelectrical methods in pre-investigation for construction in rock

Keywords

Geoelectrical imaging, applied geophysics, pre-investigation, borehole geophysics, Value of Information Analysis (VOIA)

Published by

Engineering Geology, Lund University

Printed by

Media-Tryck, Lund 2010

All rights reserved, © 2010 by the author

ISBN 978-91-976848-6-6

ISRN LUTVDG/(TVTG-1028)/1-187/(2010)

Acknowledgements

This thesis was completed with help and inspiration from several people. I would like to express gratitude to all who have helped me over the last years, but some people deserve special thanks.

First of all I would like to thank my main supervisor Torleif Dahlin and my co-supervisors Gerhard Barmen and Robert Sturk. You have always helped in any way you could. Also Leif Bjelm deserves to be acknowledged for taking time to discuss the general aspects of pre-investigation.

I thank Tommy Norberg and Lars Rosén from Chalmers University of Technology for introducing me to VOIA and helping me in applying the approach to geophysics and pre-investigation. We have had many pleasant meetings and I am very impressed with your ability to contribute to multi-disciplinary work. My gratitude goes to Miriam Zetterlund, Chalmers, for letting me use some of her material.

My gratefulness goes to those financing the project; Rock Engineering Research Foundation (BeFo), Swedish Construction Industry (SBUF), Swedish Railroad Administration (Trafikverket) and Skanska-Vinci HB. My largest gratitude goes to my reference group at BeFo: Mikael Hellsten (BeFo), Bengt Ludvig (PetroTeam), Lars O. Ericsson (Chalmers University of Technology), Leif Stenberg (SKB), Thomas Sträng (SL) and Carl-Olof Söder (Sweco Viak). You gave valuable input to the project and after a meeting with you I could ride on a wave of inspiration for a long time. Special thanks go to Oskar Aurell from Skanska-Vinci HB and Robert Gass and Olle Olofsson from Swedish Railroad Administration (Trafikverket) who always were ready to answer questions and give valuable comments on my work.

I would also like to thank former and present colleagues at Engineering Geology for interesting discussions at the coffee breaks. Special thanks go to the morning-gang: Jan-Erik Rosberg, Kjell Andersson, Conny Svensson and Ingvar Svensson. During the last years I have learned much about Swedish football and history. Also Cecilia Mildner has been a great help taking care of the administrative issues and we have had many pleasant talks.

I thank Richard Owen for comments and language corrections of my thesis.

My parents, Inger and Svend Åge Danielsen, deserve special thanks. You have supported me and helped babysitting in this last very hectic period. It feels good knowing that you always are prepared to help. I thank my brothers Bo Ensted Danielsen and Jens Ensted Danielsen for taking the time to discuss my work and give valuable input on project management and VOIA.

The most important thanks go to my beloved husband Heine and my sunshine Niels. Heine, you have read my work and supported me all the way. Writing an article with you was very easy because you are so incredibly skilled. I am very proud of being your wife! Niels, you always bring happiness into my life. Sitting on the floor plying with you and your trains makes all troubles disappear. Heine and Niels, you are my everything and I am looking forward to share new adventures with you.

Lund 2010-12-13
Berit Ensted Danielsen

Abstract

Construction in rock is associated with risks because knowledge of the geology and ground conditions is limited. Unforeseen rock conditions involve a large risk to the project and can in the end entail delays and extra costs. To minimize the risks, an optimized pre-investigation program has to be conducted where essential information is gathered in order to make the best decisions throughout the construction project.

In this Ph.D. thesis the main focus has been on the applicability of geoelectrical methods as a tool for predicting geological and rock mass conditions. The application of the geoelectrical methods at different scales has been proved to provide useful information at different stages of rock tunnel construction. In the geological setting at the Hallandsås Horst the method can indicate fractured, water bearing rock, weathered rock and to some extent lithology changes in crystalline bedrock. Large scale geoelectrical imaging is useful in the design/production planning stage and in the construction stage. Geoelectrical measurements are performed at a more detailed scale between two horizontal boreholes mainly in the construction stage. At even more detailed scale, geoelectrical methods may be combined with other geophysical methods in borehole logging and be applied late in the design/production planning stage. Additionally, borehole geophysics is important for in situ correlation/verification of the large-scale geoelectrical data.

In an attempt to demonstrate the applicability of geoelectrical imaging in pre-investigations for rock tunnel construction, a framework for Value of Information Analysis (VOIA) has been developed. The VOIA is used for choosing the pre-investigation program best suited for a specific geological environment. VOIA is based on Bayesian statistics and cost-benefit analysis and is suitable for problems where different alternatives are evaluated and compared. In VOIA the cost for new information is compared with the reduced risk for taking an economically unfavourable decision. New information is only interesting when it can change the outcome of the decision and thus is of value for the decision-maker. The cost of an investigation or measurement should be less than what is expected to be saved; otherwise the investigation should not be made. The VOIA of geophysical methods used in pre-investigation showed indisputably that the value of performing geoelectrical imaging and ground based magnetic measurements prior to drillings has a higher value than only drilling. This result is only valid for this particular geological setting and is site specific. Nevertheless the framework can help designing the best measurement program for a specific geological setting if the VOIA is used to decide between different geophysical methods, e.g. geoelectrical imaging, seismic, magnetic or a combination. The framework developed has the potential to become an integral part of any pre-investigation.

With an optimized pre-investigation with well integrated results, the uncertainty in the engineering geological prognosis is reduced and the risk that something unexpected happens is reduced. Geoelectrical imaging and borehole geophysics contributes to reduce the uncertainties and should therefore be considered as a prospective part of all pre-investigations as well as the production stage.

Table of contents

1	Introduction.....	1
1.1	Background	1
1.2	Aim and objectives.....	2
1.3	Limitations.....	3
1.4	Description of the papers.....	3
2	Case studies.....	7
2.1	Pungwe water tunnel, Zimbabwe	7
2.2	Hallandsås railway tunnel, Sweden.....	10
2.3	Citytunneln, Sweden	12
3	Pre-investigation	15
3.1	Engineering geological information and prognosis.....	15
3.2	Flow in pre-investigation.....	17
4	Applied geophysics in rock tunnel construction	19
4.1	Goelectrical imaging.....	19
4.2	Borehole geophysics.....	21
4.2.1	Natural gamma log.....	22
4.2.2	Caliper log.....	22
4.2.3	Long/Short Normal Resistivity log.....	23
5	Goelectrical methods applied at Hallandsås Horst, Sweden.....	25
5.1	Geological setting.....	25
5.2	Goelectrical and IP imaging used for pre-investigation at a tunnel project.....	26
5.3	Numerical modelling of resolution and sensitivity of ERT in horizontal boreholes	29
5.4	Borehole geophysics provides detailed information in pre-investigation for rock tunnel construction	30
5.5	Geophysical logging as a tool for identifying initial weathering in crystalline rocks.....	35
5.6	Comparison of goelectrical imaging and tunnel documentation at the Hallandsås Tunnel, Sweden.....	38
5.7	Summary and discussion	41
6	Framework for the application of Value of Information Analysis.....	43
6.1	Theory.....	44
6.2	Tunnel project	47
6.3	Estimation of probabilities	48
6.4	Framework	48
6.4.1	Prior analysis	49
6.4.2	Preposterior analysis.....	51
6.4.3	Value of perfect information.....	51
6.4.4	Expected value and expected net value.....	52
6.5	Sensitivity analysis.....	52
6.6	Discussion	53
7	Discussion	55
7.1	Evaluation of Goelectrical methods	55
7.2	Value of Information Analysis	57
7.3	Essentials for successful pre-investigation.....	58
7.3.1	Geological setting (complexity, hazards)	58
7.3.2	Existing information in a national geo-database.....	59
7.3.3	Central project database to handle geo-data	59
7.3.4	Consistency in pre-investigation report	60
7.3.5	Communication	60

Table of contents

7.3.6 Integration of knowledge	60
7.3.7 Realistic expectations	60
7.3.8 Experience/skills	61
7.3.9 The importance of the contract form.....	61
8 Conclusions.....	63
9 Recommendations.....	65
10 References.....	67

List of papers

- Paper 1 Danielsen, B.E., Arver, H., Karlsson, T. and Dahlin, T. (2008) Geoelectrical and IP imaging used for pre-investigation at a tunnel project. *Conference proceeding. 14th Meeting Environmental and Engineering Geophysics, Krakow, Poland, 15-17 September 2008, P44, 4p.*
- Paper 2 Danielsen, B.E. and Dahlin, T. (2010) Numerical modelling of resolution and sensitivity of ERT in horizontal boreholes. *Journal of Applied Geophysics. 70: 245-254*
- Paper 3 Danielsen, B.E. (2010) Borehole geophysics provides detailed information in pre-investigation for rock tunnel construction. Submitted for publication to *Canadian Geotechnical Journal*.
- Paper 4 Danielsen, B.E. and Madsen, H.B. (2010) Geophysical logging as a tool for identifying initial weathering in crystalline rocks. Submitted for publication to *Near Surface Geophysics*.
- Paper 5 Danielsen, B.E. and Dahlin, T. (2009) Comparison of geoelectrical imaging and tunnel documentation at the Hallandsås Tunnel, Sweden. *Engineering Geology. 107: 118-129*
- Paper 6 Danielsen, B.E., Norberg, T. and Rosén, L. (2010) Framework for Value of Information Analysis applied to geophysical methods used for pre-investigation. *Manuscript*.

Related conference papers

Danielsen, B.E., Dahlin, T. and Danielsen, J.E. (2005) Model study of the resolution of resistivity tomography with different electrode arrays. *Conference proceeding. 11th Meeting Environmental and Engineering Geophysics, Palermo, Italy, 4-7 September 2005, P082, 4p.*

Danielsen, B.E. and Dahlin, T. (2006) Geophysical and Hydraulic Properties in Rock. *Conference proceeding. 12th Meeting Environmental and Engineering Geophysics, Helsinki, Finland, 4-6 September 2006, P062, 4p.*

Danielsen, B.E. and Dahlin, T. (2007) Comparison between geoelectrical imaging and tunnel documentation. *Conference proceeding. 13th Meeting Environmental and Engineering Geophysics, Istanbul, Turkey, 3-5 September 2007, 4p.*

Danielsen, B.E. and Dahlin, T. (2008) Numerical Modelling for Improvement of the Interpretation of Geoelectrical and Induced Polarization Measurements. *Conference proceeding. 14th Meeting Environmental and Engineering Geophysics, Krakow, Poland, 15-17 September 2008, A06, 4p.*

Danielsen, B.E. and Madsen, H.B. (2010). Difference in resistivity explained by initial stage of weathering. *Conference proceeding. 16th Meeting Environmental and Engineering Geophysics, Zurich, Switzerland, 6-8 September 2010, P03, 4p.*

1 Introduction

1.1 Background

Construction in rock is associated with risks as the knowledge of the geology and ground conditions usually is limited. Unforeseen rock conditions involve a large risk to the project and can in the end entail delays and extra costs. To minimize the risks, a profound and optimized pre-investigation has to be conducted where the necessary information is gathered in order to make the best decisions throughout the construction project (Baynes et al., 2005; Ngan-Tillard et al., 2010).

Different geophysical methods are important in these investigations. Geoelectrical imaging is one of the geophysical methods that have proved to be important at a large scale, especially for pre-investigations at the feasibility stage (e.g. Cavinato et al., 2006; Dahlin et al., 1999; Danielsen and Dahlin, 2009; Ganerød et al., 2006; Rønning, 2003; Stanfors, 1987). The method can also be relevant in small scale and used for cross hole tomography studies (e.g. Daily et al., 1995; Daily and Owen, 1991; Danielsen and Dahlin, 2010; Deceuster et al., 2006; Denis et al., 2002; French et al., 2002; Goes and Meeke, 2004; Guérin, 2005; LaBrecque et al., 1996) and as logging tool (e.g. Daniels and Keys, 1990; Ellis and Singer, 2007; Ernstson, 2006; Howard, 1990; ISRM, 1981; Paillet and Ellefsen, 2005; Rasmussen and Bai, 1987; Schepers et al., 2001; Segesman, 1980). However, the authors experience from several unpublished pre-investigation reports from tunnel projects in Sweden is, that the method has not been fully recognised as an integrated part of the pre-investigations.

In this Ph.D. thesis the main focus is on the applicability of the geoelectrical method as a tool for predicting geological and rock mass conditions. By applying the geoelectrical method at different scales and together with other geophysical methods it has proven to give useful information at different stages of rock tunnel construction. For this geoelectrical data measured at the Hallandsås Horst in Southern Sweden are evaluated regarding its ability to resolve different properties of the rock mass.

The results of the geophysical measurements usually have to be processed and evaluated by a geophysicist. The geophysicist knows the sensitivity and resolution of the methods. Thus the decision maker does not always have appropriate understanding of the advantages and limitations of the various geophysical methods. On the other hand the geophysicist does not always have detailed understanding of what the decision maker requires; e.g. at what scale information is needed. One task for the decision maker and the geophysicist is to find a common language. Value of information analysis (VOIA) might be an approach for communicating with the decision makers.

VOIA can help to create a rational design strategy for investigation programmes. The method is based on Bayesian statistics and cost-benefit analysis and is suitable for problems where different alternatives are evaluated and compared, e.g. the design of an investigation programme when the number of measurements or investigations needs to be determined. In VOIA the value of new information, from measurements for example, is assessed by estimating the uncertainties in the present information compared to the expected reduction in uncertainty following collection of new information. The cost and the time it takes to obtain better information must be compared to what can be saved by modifying the investigation programme. New information is only interesting when it can change the outcome of the decision and thus is of value for the decision maker. The cost of an

investigation or making a measurement should be less than what is expected to be saved; otherwise the investigation should not be made (Bedford and Cooke, 2001; Freeze et al., 1992).

To our knowledge the VOIA approach has never been applied to geophysical methods used in pre-investigations for rock tunnel constructions. One of the central tasks is to evaluate how good different geophysical methods are at detecting problematic rock conditions in otherwise good rock. Because such estimation can be biased (based on experience, affiliation etc.), our approach is to ask geophysical experts to judge this in order to get a more objective result. The experts will be presented with a number of simulations of tentative rock volumes and the estimate should be based on those. The expert's opinion is then the foundation for the probability used in the VOIA. It is also important to remember that the estimate is only valid for a specific geological setting. In the framework developed in this thesis a hypothetical example is used, but it is inspired by the construction of the Hallberg tunnel in Sweden.

1.2 Aim and objectives

The overall aim with this thesis is to investigate the applicability of geoelectrical methods in pre-investigation for hard rock tunnel construction. The purpose of the work is to make engineers and decision makers recognise the importance of planning and execution of a pre-investigation program including geophysics and in particular geoelectrical imaging.

The overall aim with this thesis is achieved by evaluation of geoelectrical methods in different scales, case studies, theoretical studies and development of a framework for VOIA. The work is presented in six papers:

- Paper 1: Geoelectrical and IP imaging used for pre-investigation at a tunnel project.
- Paper 2: Numerical modelling of resolution and sensitivity of ERT in horizontal boreholes.
- Paper 3: Geophysical logging for enhancement of borehole information in pre-investigation for rock tunnel construction.
- Paper 4: Geophysical logging as a tool for identifying initial weathering in crystalline rocks.
- Paper 5: Comparison between geoelectrical imaging and tunnel documentation at the Hallandsås Tunnel, Sweden.
- Paper 6: Framework for Value of Information Analysis applied to geophysical methods used for pre-investigation.

The specific objectives have been fulfilled by:

- Giving examples on how pre-investigation was done in three tunnel projects and what the outcome was for the projects (Chapter 2).
- Creating a flow chart for pre-investigation (Chapter 3).
- Demonstrating the applicability of the geoelectrical method in different scales (Chapter 5).
- Developing a framework for VOIA for geophysical methods prior to drillings (Chapter 6).

- Assessing the possibilities, strengths and weaknesses of the geoelectrical imaging and the application of VOIA (Chapter 7).

Chapter 4 presents the most common geophysical methods. Chapter 6 presents the theory behind VOIA. Chapter 8 summarises the conclusions of the work and chapter 9 presents some recommendations for the future work within this research area.

1.3 Limitations

Attempting to apply general rules to geological problems always involves limitations. The true complex geology can never be fully explained by a model. Even though some general remarks about the flow scheme in a pre-investigation is given in chapter 3 the main focus in this thesis is on the applicability of geoelectrical methods used in different scales in pre-investigation for hard rock tunnel construction. It is also important to stress that there exist several other useful geophysical methods to consider when planning a pre-investigation and that the information from the geophysical methods only is a part of the compilation of an engineering geological prognosis.

For the application of VOIA there are several limitations. The framework developed is a simplification of reality where e.g. only two different rock classes are considered. Additionally is the framework only tested on one tunnel project and it is important to remember that a VOIA is site specific. Even though a large effort was put into finding the correct economic key numbers some assumptions had to be made concerning the additional cost due to unexpected events during tunnel construction.

1.4 Description of the papers

The first large scale geoelectrical imaging measurements were carried out at the Hallandsås Horst in 1998 (Fig. 2.6) and paper 1–4 in this thesis can be considered as natural successors following the top-down approach in a pre-investigation (Fig. 1.1). In paper 5 the geoelectrical imaging data measured during pre-investigation is evaluated for the use in the construction stage. A VOIA should ideally be made prior to additional measurements in order to evaluate if it is worthwhile to make them. Thus there should be a VOIA prior to each of the papers 1-4. However, the VOIA in paper 6 is a framework developed to help decide if it is worthwhile to perform the measurements in paper 1.

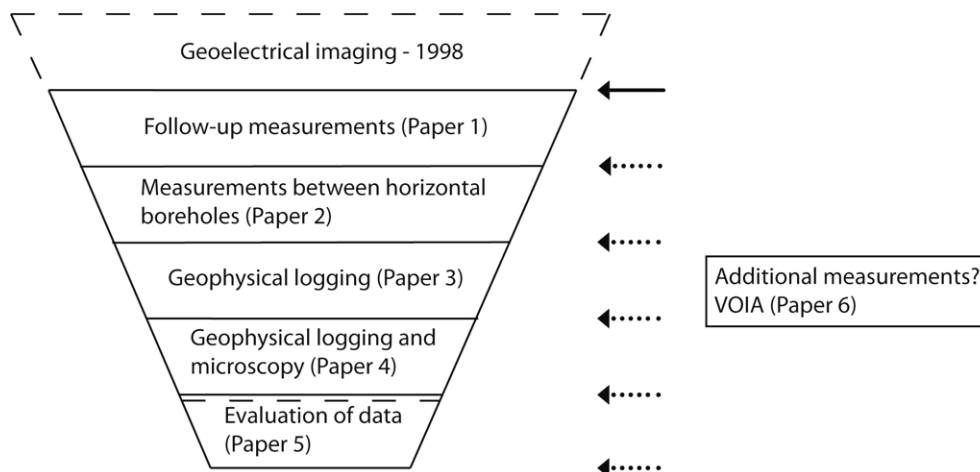

Figure 1.1. The flow in the papers presented in this thesis.

Paper 1: Geoelectrical and IP imaging used for pre-investigation at a tunnel project

In this extended abstract geoelectrical and IP imaging are combined with ground based magnetic measurement to compile a geological model of 900 metre of the Hallandsås Tunnel, Southern Sweden. IP proved to be useful at locating dolerites and resistivity was useful for the general distribution of fractures. Magnetic measurements are a good supplement to pinpoint the exact position of the dolerite. Based on the general geologic information, resistivity and IP measurements, recommendations can be given on where to drill in order to improve the geological model.

Paper 2: Numerical modelling of resolution and sensitivity of ERT in horizontal boreholes

In this paper resistivity is measured in horizontal boreholes to obtain information about the rock volume between the boreholes. This is an attempt to identify a suitable methodology for an effective measuring routine for this type of geophysical measurements under actual construction site conditions. Prior to any measurements numerical modelling was done to evaluate the resolution of different electrode arrays, the sensitivity towards inaccurate borehole geometry and the influence of water in the boreholes.

Paper 3: Borehole geophysics provides detailed information in pre-investigation for rock tunnel construction

Focus in this paper is how borehole geophysical logging can provide high resolution and detailed information about the lithology change, fractures and weathering of crystalline bedrock. In two core drilled and one percussion drilled boreholes at the Hallandsås Horst, Southern Sweden, geophysical logging with gamma, caliper and short/long normal resistivity was performed. The results suggest that logging should be done in non-cored boreholes as a cheaper alternative to core drilled holes.

Paper 4: Geophysical logging as a tool for identifying initial weathering in crystalline rocks

The scope of this paper is to show how even low degrees of weathering of rocks affects the geophysical log response, by means of thin section microscopy, point counting and logging. This was done on gneisses and amphibolites from two drill cores done in connection with the construction of the Hallandsås Tunnel, Southern Sweden. The resistivity logs can detect even low grades of weathering of amphibolites which can be important for the mechanical properties of the rock.

Paper 5: Comparison of geoelectrical imaging and tunnel documentation at the Hallandsås Tunnel, Sweden

In this work the electrical imaging is evaluated with regards to the method's applicability. The evaluation is done qualitatively by comparing the electrical imaging with tunnel documentation from a tunnel in Southern Sweden. By evaluating the result continuously when constructing the tunnel, a more detailed geological prognosis can be compiled and used in continuing work with the tunnel. The parameters used for the comparison are lithology, Q, RQD, weathering and water leakage. The result was that virtually every change in electrical resistivity image coincides with a change in rock conditions. The general trend was that high resistivity corresponded with good quality gneiss whereas low resistivity corresponds to poor quality rock e.g., high weathering, low RQD, low Q and/or several lithological contacts. The intermediate resistivity is often amphibolites or rock with water bearing fractures. The results were supported by in-situ resistivity measurements inside the tunnel and resistivity logging in a core drilling.

Paper 6: Framework for VOIA applied to geophysical methods used for pre-investigation

VOIA is a cost-benefit analysis of different decision alternatives. In this framework decisions have to be made about how to proceed with pre-investigations for the construction of a rock tunnel. It has to be decided if geophysics should be done prior to drillings. The value of information gained by doing geophysics as part of the pre-investigation is estimated.

2 Case studies

The quality of a pre-investigation and how the information is integrated in the decisions can have huge importance for the outcome of a construction project. In the following three examples of how the pre-investigations in different tunnel projects have been performed and what the consequences were for the projects will be given. The examples are from different geological settings and conditions and therefore cannot be compared directly. The projects are described only briefly and should be seen as an appetizer and explanation to why this thesis is built up as it is.

2.1 Pungwe water tunnel, Zimbabwe

In the late 1990's a water tunnel in the Pungwe-Mutare Water Supply Project in the eastern Zimbabwe was constructed by Skanska. The purpose was to lead water from the Pungwe river, which runs through the Nyanga National Park, to the city of Mutare (Fig. 2.1).



Figure 2.1. Map to the left shows Zimbabwe with the position of the Nyanga National Park (red square) and the city of Mutare. The map to the right shows the approximate tunnel line, with the intake in the north-eastern end. Maps are modified from Henriksson (1996) and mappery.com (2010).

The water is transported through a 4 km long tunnel and 96 km pipeline. For 1 km the tunnel runs through the Nyanga National Park with high environmental responsibilities as a consequence. A minimum of environmental disturbance was required and thus no test drillings were allowed in the national park at this time (Henriksson, 1996). The tunnel with a diameter of 4 metre is constructed in granitic and gneissic rock with fracture zones and deep weathering. Additionally, the terrain is rough and no road access to the tunnel line exists (Dahlin, 1998). Older test drilling results were available and in 1973 the Geological Survey of Zimbabwe performed a preliminary geological report which included these 7 core drillings (Fig. 2.2). The drill holes were distributed along the tunnel line as it was intended at that time. In several of the core drillings fractured and highly weathered rock was encountered above tunnel level but at 60 m relevant to the proposed tunnel the rock is fresh and unfractured. However at the intake there are several dolerite dykes with vertical jointing. Thus the recommendation was to do a more thorough pre-investigation at the water intake area (Kirkpatrick,

1973). When the pre-investigation was resumed in 1997 a 950 metre long CVES profile was performed along the tunnel line (Dahlin, 1998), see figure 2.2.

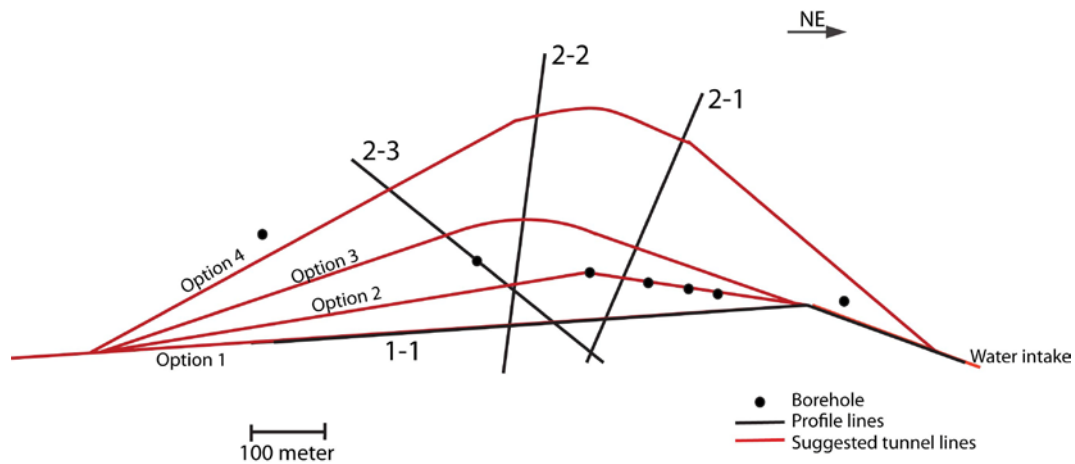

Figure 2.2. Sketch of the Pungwe tunnel, profile line 1-1, 2-1, 2-2 and 2-3 (black lines) and suggested tunnel lines (red lines). The boreholes from 1973 are marked with black dots.

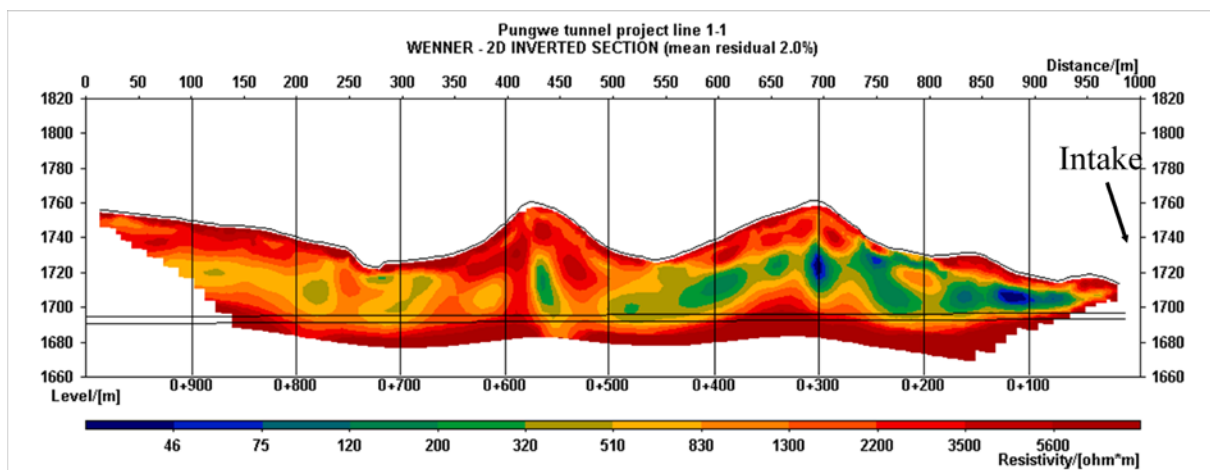

Figure 2.3. 2D resistivity model based on the CVES data from profile line 1-1. The two horizontal parallel lines mark the position of the planned tunnel. From Dahlin (1998).

The CVES data showed that the resistivity was a few hundred Ωm at tunnel level (Fig. 2.3) which indicated very poor rock quality with fractured rock and deep weathered zones. A horizontal borehole from the intake point confirmed the poor rock quality. This would create large problems for the tunnel construction and make it difficult to match the demands for minimal environmental disturbance. Thus additional CVES profiles were measured perpendicular to the planned tunnel line (Fig. 2.2). The three profiles (Fig. 2.4) showed that in the northern part of the line the resistivity was higher than $3500 \Omega\text{m}$ and therefore was considered as rock with few fractures and without deep weathering. Due to the detected weathering the tunnel line was moved from option 1 to option 4 (Fig. 2.2), avoiding extra construction time and costs. If the tunnel had followed the original planned line it would have been difficult for Skanska to accomplish the high environmental demands (Dahlin, 1998).

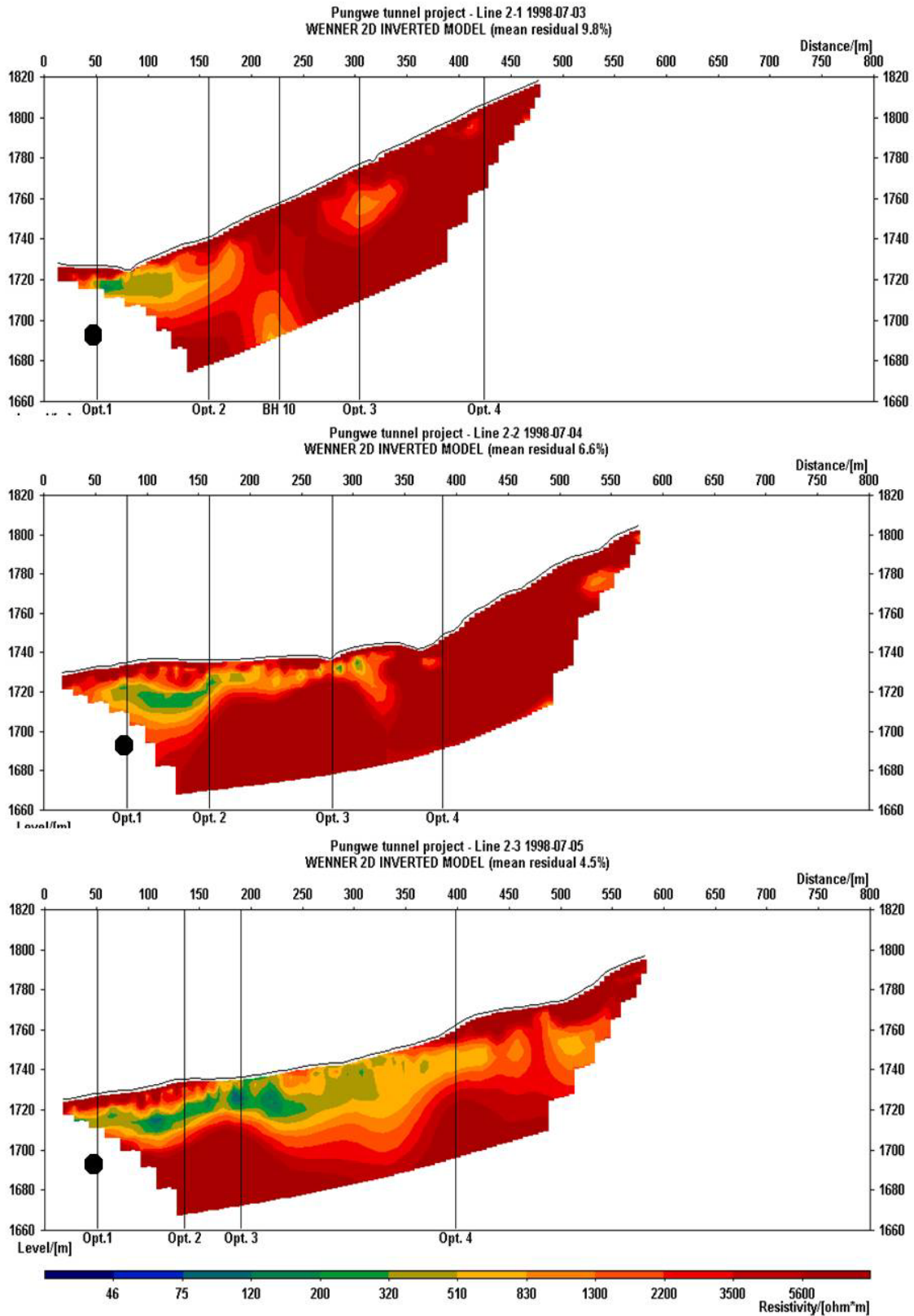

Figure 2.4. The CVES profiles, 2-1, 2-2 and 2-3. The four vertical lines mark the four different tunnel options, where the original option 1 is marked with a black dot. From Dahlin (1998).

2.2 Hallandsås railway tunnel, Sweden

The railway tunnel through the Hallandsås Horst is a well-known project in Sweden that from time to time has taken up large space in the media due to extensive delays and budget overruns. It is a 8.6 km long twin track tunnel through the most northern part of the Scanian horsts (see figure 2.5 and chapter 5.1 and 5.2 for more information about the geological setting). When the project started in 1992 the plan was to complete construction in 1996. The new time schedule aims for 2015 with a total budget of 10.5 billion SEK (2008 monetary value) (Trafikverket, 2010).

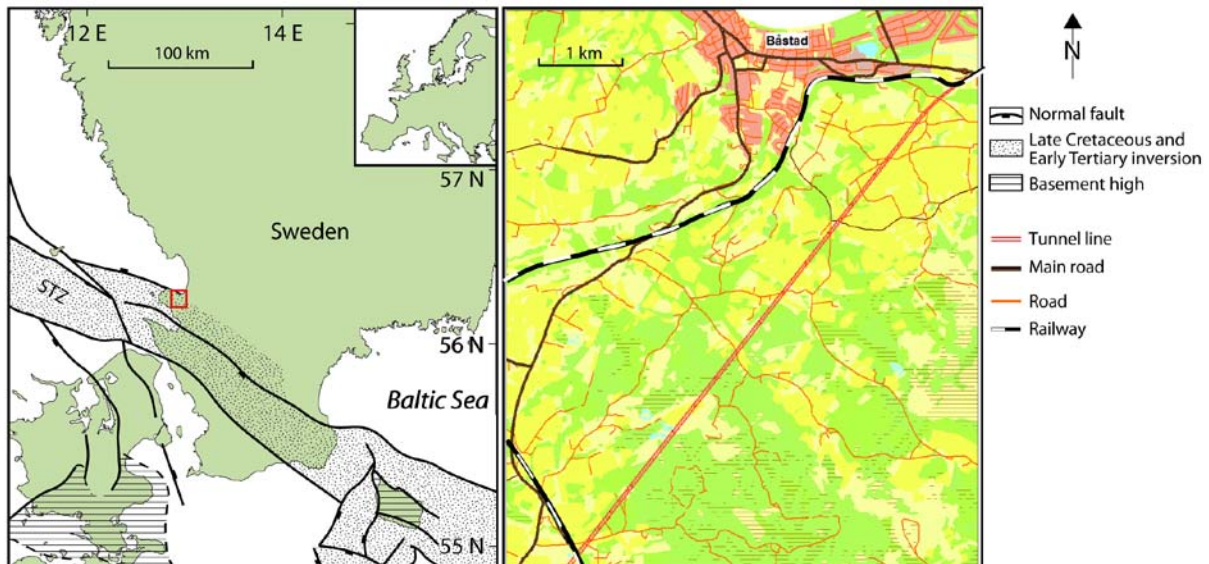

Figure 2.5. Left: Map of Southern Sweden showing the position of the investigation area and the outline of the Tornquist Zone (STZ). Right: The tunnel line. Maps are modified from Graversen (2009), Lantmäteriverket (2001) and Liboriussen et al. (1987).

The Swedish company *Kraftbyggarna* started constructing the tunnel in 1992 using an open tunnel boring machine (TBM). This turned out to be a wrong approach because the TBM was designed for competent hard rock. However the first hundred of metres was weathered rock partly with mechanical properties similar to stiff clay. In 1993 *Kraftbyggarna* began using a drill and blast approach instead. In 1995 *Kraftbyggarna* left the project after constructing 3 km of the tunnel, due to an economic dispute with the project owner, *Banverket* (Swedish Railroad Administration). In 1996 *Skanska* continued the work using drill and blast as excavation method. *Skanska* made an opening in the central part of the horst so that they could continue the work on four additional adits, giving a total of eight adits. However within the first year problems with high groundwater leakage into the northern part of the eastern tunnel arose. The groundwater level dropped and wells in the vicinity dried out. Several different sealing products were tested; among those the internationally used chemical sealant *Rhoca Gil*. In 1997 the use of the product was terminated because high water flow prevented the sealant from hardening and as a consequence contaminated the water in the streams with acrylamide. This caused fish to die and cattle to get sick from drinking water from the streams. The work was ceased and did not commence until 2003 when the consortium *Skanska-Vinci* continued the project with a completely new method including a shielded TBM and continuous concrete lining as means to control the water ingress to the tunnel on both short and long term. Then in 2003 a major leakage of grout penetrated the rock mass at *Lyabäcken* and again fish died. This time the *Mölleback* rock deformation (MBZ, see figure 2.6) was the reason. When the TBM

started drilling in 2005 one third of the tunnels were finished. In August 2010, the East tunnel was successfully completed and in total 69% of the tunnels were complete and it is planned that traffic through the tunnels will commence in 2015 (Trafikverket, 2010).

Table 2.1. A summary of the pre-investigation performed in connection to the Hallandsås Tunnel during the three major investigation intervals (Banverket, 1996; Banverket, 2002; VBB VIAK, 1999).

	1989-1990	1994-2000	2001-2002	Comments
Geophysics				
Seismics	10.5 km	3.6 km		
VLF	19.2 km	6.4 km		
DC resistivity, profiling	8.5 km			
DC resistivity, sounding	23 soundings in 17 points			
DC resistivity, CVES		14.25 km	2.8 km	Shorter profiles in the MBZ, SMZ and NMZ
Magnetics	8.5 km			
Slingram	6 km			
Drillings				
Soil-rock penetration	10			
Percussion drilling	25	11		
Core drilling	13	20*	13	* 5 are horizontal from tunnel level and 2 are wire-line core drillings
Hydraulic tests				There exists a large monitoring project where the groundwater level is measured regularly
From percussion drilling	25	11	13*	* Water-loss measurements
Pump test	6	2		
Geophysical logging		2		
Laboratory tests	13			E.g. point load index, mechanical properties, E-module and Poisson's number

During the project it has become obvious that the geological setting is unusually complex by Swedish standards and as a consequence further investigations have been performed on several occasions from 1989–1990, 1994–2000 and 2001–2002 (Tab. 2.1). However, the tunnel project has the reputation that the parties were not prepared for the complex geology. Prior to project start the most extensive pre-investigation was done where several different geophysical methods were used (Tab. 2.1). The Hallandsås Tunnel succeeds another large tunnel project in Scania, the Bolmen tunnel. In the Bolmen Tunnel project different geophysical methods had been of high value (Stanfors, 1987). In one area geophysical data even changed the tunnel line position due to poor rock quality (Backblom and Stanfors, 1986). The successful use of geophysical methods may have been the reason why so many different methods were used at the Hallandsås. The main focus was on the known difficult areas with poor rock quality, which were the northern (NMZ) and southern marginal zones (SMZ), whereas very little focus was on the central parts where good rock quality was

expected. Despite the amount of work focussed on SMZ and NMZ, the project managers were taken by surprise by the failure of the first TBM in the poor rock in NMZ. How this happened is not for the author to speculate, but a lesson to be learned. Thus in this case it did not matter how much pre-investigation was done or how many different methods were applied since the information was not fully used and integrated in the decision-making.

The long project history with several pre-investigation campaigns conducted by varying consultants and changing contractors may create difficulties in handling the many different kinds and generations of data. The hydraulic data from the many observation wells are gathered in a database. But other types of geo-data, different raw data and interpreted models, are not gathered in a central database which otherwise would be beneficial to a project of this kind.

Since 2003 the project has learned from history and worked intensively with the engineering geological prognosis and with geological data in general. The geological setting is complex and extremely heterogeneous which demands a large focus on the geological data. A positive tendency in the project is that the geoelectrical imaging profiles (e.g. Fig. 2.6) are used actively in the planning of the use of the TBM and not only applied to the areas containing rock of poor quality but also to the areas with good rock quality.

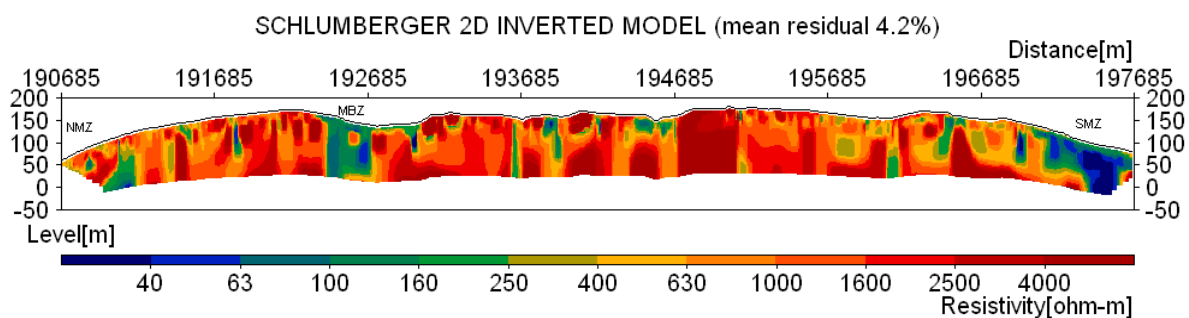

Figure 2.6. The 7 km long geoelectrical imaging (CVES) profile along the tunnel line.

2.3 Citytunneln, Sweden

In Malmö, southern Sweden, a railroad tunnel project called Citytunneln is a good example of how a well planned and integrated pre-investigation can benefit a project. The Citytunneln is a 17 km long railway project of which 6 km is two parallel single track tunnels. The tunnels are drilled beneath the central parts of the city of Malmö, see figure 2.7. The geological setting is not as complex as for the Hallandsås Tunnel, and is mainly a relatively impermeable and homogeneous Bryozoa limestone.

The project is unique because it is the first major infrastructure project in Sweden where the environmental impact of the project has been tested in the Environmental Court according to the Environmental Code. The Environmental Court have set detailed conditions for e.g. the maximum drawdown and amount of groundwater that may be pumped away and what amount has to be re-injected. On this basis, agreements with contractors had to be made, i.e. choice of working methods and the materials and chemicals used (Citytunnelprojektet, 2003).

The strict environmental demands set by the Environmental Court made it necessary to do an extensive pre-investigation. A summary of the pre-investigation performed in the tunnel part of the

project is presented in table 2.2. The first drilling campaign started in 1995 and later several others followed. In the project phase more than 300 drillings were done, and in nearly half of them borehole geophysical logging was performed, providing detailed in situ information about the rock properties (VBB-COWI Joint Venture, 2000a). CPT-soundings, core drillings and percussion drillings were done and rock was sampled for laboratory tests, e.g. mechanical strength and density. Seismic surveys (26 km) provided information of structures and faults in the limestone (VBB-COWI Joint Venture, 2000c). To a small extent surface wave seismic and CVES profiles were tested in a limited area in Lockarp (Wisén and Christiansen, 2005). Pump tests were conducted to make a characterization of the aquifer, e.g. transmissivity and storage coefficient (VBB-COWI Joint Venture, 2000b). All information was gathered in a database and used for an integrated engineering geological prognosis. In addition to data obtained during the project the database also contained more than 9000 boreholes drilled prior to the project, which mainly contributed with stratigraphic information. The database was accessible to all the involved parties (VBB-COWI Joint Venture, 2000c).

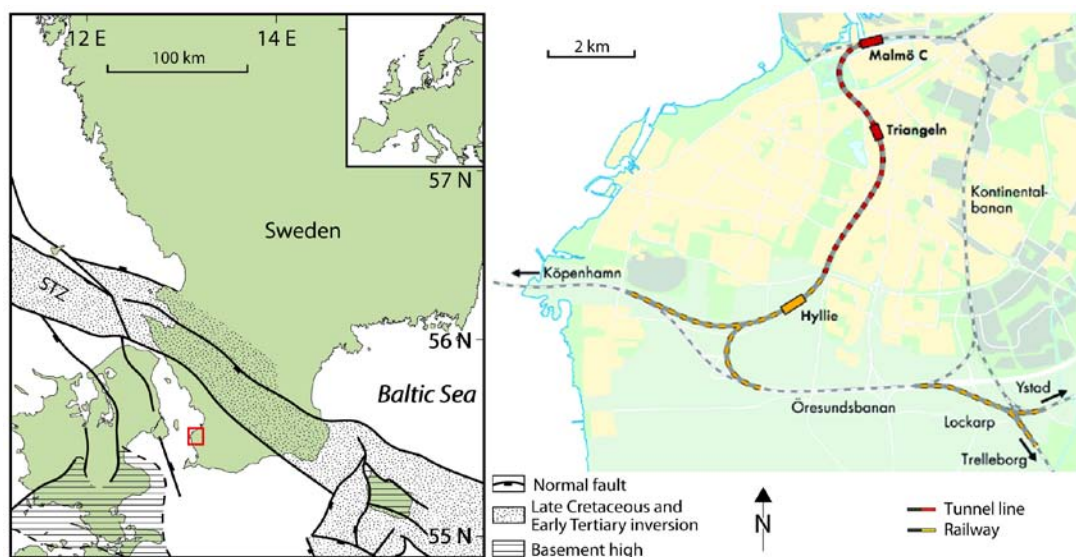

Figure 2.7. Left: Map of Southern Sweden showing the position of the investigation area and the outline of the Tornquist Zone (STZ). Right: The city of Malmö with the tunnel line. Maps are modified from Liboriussen et al. (1987), Graversen (2009) and Citytunnelprojektet (2003).

The extensive pre-investigation took relatively long time and had a high cost compared to earlier construction projects in Sweden. A possible question is if the pre-investigation was too extensive, but with the high demands from the Environmental Court and a tunnel constructed beneath a city, the ambitions regarding the pre-investigation has to be very high. What can be concluded is that the extensive pre-investigation was a contributing factor to a relatively smooth construction. The tunnel was inaugurated 6 months ahead of schedule with a total cost of 8.565 billion SEK which is 1 billion SEK lower than budgeted (Citytunnelprojektet, 2003).

Table 2.2. A summary of the pre-investigation performed in connection to the Citytunneln during the project phase (only from the tunnel part) (Based on VBB-COWI Joint Venture, 2000a, b, c).

	1995-2000	Comments
Geophysics		
Seismics, refraction	11 km	
Seismics, reflection	16 km	
Drillings		
Soil-rock sounding	12	
Percussion drilling	250	
Core drilling	52	
Hydraulic tests		There exists a large monitoring project where the groundwater level is measured regular
Capacity test	107	
Pump test	25	Short and long term
Geophysical logging	138	
Laboratory tests	45	E.g. mechanical properties, E-module and Poisson's number.

3 Pre-investigation

A major problem when constructing tunnels is unforeseen rock conditions e.g. water leakage and changes in rock mechanical properties. In a study conducted by Malmtorp and Lundman (2010) it was concluded that uncertainty in the engineering geological prognosis led to delays and raised budgets. To reduce the uncertainty a high-quality engineering geological prognosis is necessary.

The scope of a pre-investigation will essentially be driven by the need to answer questions about the geology, by knowledge of the engineering requirements of the project and appreciation of what level of knowledge is appropriate for satisfactory engineering. The objective of any investigation is maintained by exchange of information between the project owner and consultant. It should be the responsibility of the engineering geologist/geophysicist to determine an appropriate scope for the pre-investigation within a reasonable budget (Baynes, 2003).

Decision makers are in most cases aware of the importance of pre-investigation, but nevertheless the deciding factors are time and money. It takes time to perform, interpret and compile the measured data and time costs money. Looking at a budget for a project it is easy to identify the cost for a thorough pre-investigation. However, what has to be acknowledged is that with a thorough and optimised pre-investigation the uncertainty is reduced and that will in the end save time and money. Unfortunately this is not so easy to quantify and is not an obvious entry in a budget.

3.1 Engineering geological information and prognosis

The aim with the pre-investigations is to prepare an engineering geological prognosis for the construction site which answers a number of key questions. Key questions are the demands for information on engineering geology issues. To be able to investigate and evaluate the relevant aspects of the bedrock, the key questions have to be defined for each individual project before a pre-investigation strategy is identified (Almén et al., 1994; Bergman and Carlsson, 1988). Some key questions could be rock type, weathering/rock cover, rock stress, presence of water and major fault zones (Sturk, 1998).

The geological prognosis is a preliminary prediction of the relevant aspects of the bedrock and is obtained by evaluating and analysing the geological information available. The geological prognosis should be problem oriented; that is it should structure the available information so physical conditions that may be of (positive or negative) technical or economic significance for the project are highlighted and presented in tangible terms. The prognosis should be dynamic so the results of new investigations become available, followed by further assessments that agree with or modify the original geological prognosis (Bergman and Carlsson, 1988; Stanfors et al., 2001).

How detailed the information in the geological prognosis needs to be depends on the stage of the construction project. The different stages are e.g. the feasibility stage, the design/production planning stage and the construction stage (Sturk, 1998). Each stage needs information at a different scale. In the feasibility stage the scale considered is regional i.e. >>1000 metre depending on the size of the project. For the design and production planning stage the scale of interest has narrowed to a site scale (100–1000 metre). In the construction stage the need for detailed information is greater

and the scale can be a block scale (10–100 metre) or a detailed scale (<10 metre) (Almén et al., 1994; Sturk, 1998). In each stage the key questions are related to certain decisions. Examples of key questions and how they could be described in each stage are seen in table 3.1.

Table 3.1. Examples of key questions and how they might be described during each stage. Modified after Almén et al.(1994) and Sturk (1998).

Key question	Feasibility stage Scale >1000 metre	Design/production planning stage Scale 100-1000 metre	Construction stage Scale <100 metre
Rock type	General knowledge. Stop signs?	Rock type distribution. Mechanical parameters for expected rock types.	Location of difficult rock types and boundaries. Stand-up time.
Weathering/ rock cover	Is deep weathering or large cover expected? Rough estimate on depth to fresh rock.	Location of areas with deep weathering or low rock cover. Estimate on depth to fresh rock. Description of geological hazards.	Exact location of areas with weathering, low rock cover and boundaries.
Rock stress	Depth of facility. Location within shields. Tectonic region.	Stress levels in area. Magnitude of stress problem. Description of squeezing and spalling rock. Distribution of problematic areas.	Location of areas with stress problems. Rock stress properties in these areas. Magnitude?
Water	Water expected or not? Rough estimate on need for grouting or sealing. Estimate of pressure levels. Possibility for flowing ground?	Hydraulic parameters of rock mass. Pressures expected. Distribution of values of hydraulic parameters. Estimate on groutability and ways of sealing tunnel.	Location of water bearing structures. Pressures and permeability. Groutability. Warning bells in current geology?
Major fault zones	Are there zones in the vicinity of the site? One or several?	Number of zones and estimate on location. Estimate on quality and width. Geological hazards.	Location, quality and width of zones. Warning bells in current geology?

The engineering geological information and prognosis have different purposes in the different project stages. The decisions should be based on data acquired by a pre-investigation campaign that has been tailored to the given geological setting. In the feasibility stage the aim is to compile the engineering geological prognosis so it gives a general picture of the geological setting in the area. If the feasibility study concludes that the project should continue, the next step is the design and production planning stage. In this stage the main questions are related to the general design which relates to excavation and support methods, capacities and costs related to these methods. These considerations lead to an estimation of the cost of the project. The key questions are the same as in the previous stage but the demand for detail is greater (Almén et al., 1994; Bergman and Carlsson, 1988; Sturk, 1998). In the construction stage the questions and decisions become more specific. Thus the engineering geological information and prognosis have to be more specific (Sturk, 1998).

In order to make the optimal decisions the key questions and the known geological settings have to be discussed by the geophysicist and the engineers prior to any investigation. In this way proper investigation methods can be applied for each stage. There will always be geological uncertainty connected with construction in rock, but decisions based on a thorough pre-investigation will reduce these uncertainties.

3.2 Flow in pre-investigation

By doing profound pre-investigations construction costs are likely to be reduced because the project parties are better prepared due to more certain rock mass problem identification. Since the pre-investigation itself involves a cost, the goal of exploration planning is to minimize the total cost of the entire construction work inclusive the pre-investigations (Einstein et al., 1978). The primary goal with a pre-investigation is to compile an engineering geological prognosis which is essential in the feasibility stage, design/production planning stage and the construction stage. The pre-investigation should be performed top down, meaning that the investigations should start on large scale and continue into more and more detail so it follows the need for information in the different project stages. The flow diagram in figure 3.2 shows how the pre-investigation preferably should be done. The boundaries between the different stages and scales are rather diffuse and should only be seen as guidelines. Thus the information from the different steps in the flow diagram should be integrated through the whole process.

In the feasibility stage the first step is to do an archive study where all old material is collected and scrutinized. This could be geological maps, topographic maps, drilling reports, airborne geophysics etc. (Danielsen, 2007). It is also important to do a field visit to get an understanding of the study area and the expected geological setting so the pre-investigation program can be tailored and the best suited methods can be chosen. In the design/production planning stage the first step is to use a quick qualitative geophysical method such as ground based magnetics or slingram. In this step it is also appropriate to do earth/rock soundings. The next step is to extend the geophysical survey with quantitative methods that are assumed to be appropriate in sensitive and critical areas, areas where information is scarce and areas where the interpretation is questionable. The large scale geophysics is followed by core drillings and percussion drillings to obtain detailed information about the rock conditions. Thus even small scale (<10 m) is important in the design/production planning stage. Starting with large scale geophysics thus makes it possible to position the boreholes in a more cost efficient way, so as much information is gained as possible. An advantage with e.g. geoelectrical imaging or seismic surveys is that a continuous model of the physical properties in the subsurface is obtained. Boreholes are point information but are essential for making a geological interpretation of the physical model obtained from the geophysical profiling methods. Thus the borehole and the borehole geophysics are valuable for interpretation and calibration of the surface based geophysics. Borehole geophysics is small scale and provides detailed information which should be performed in the final stages of the pre-investigation. The boreholes are not only useful for geophysical logging but can also be used for hydraulic tests and the extracted cores can be used for rock mechanical laboratory tests. A major concern when building rock tunnels is water leakage. Therefore it is an essential part of the pre-investigation to perform hydraulic tests. Several different hydraulic tests are useful depending on purpose and borehole/well conditions (e.g. Butler, 1990; Fetter, 2001; Gustafson, 2009)

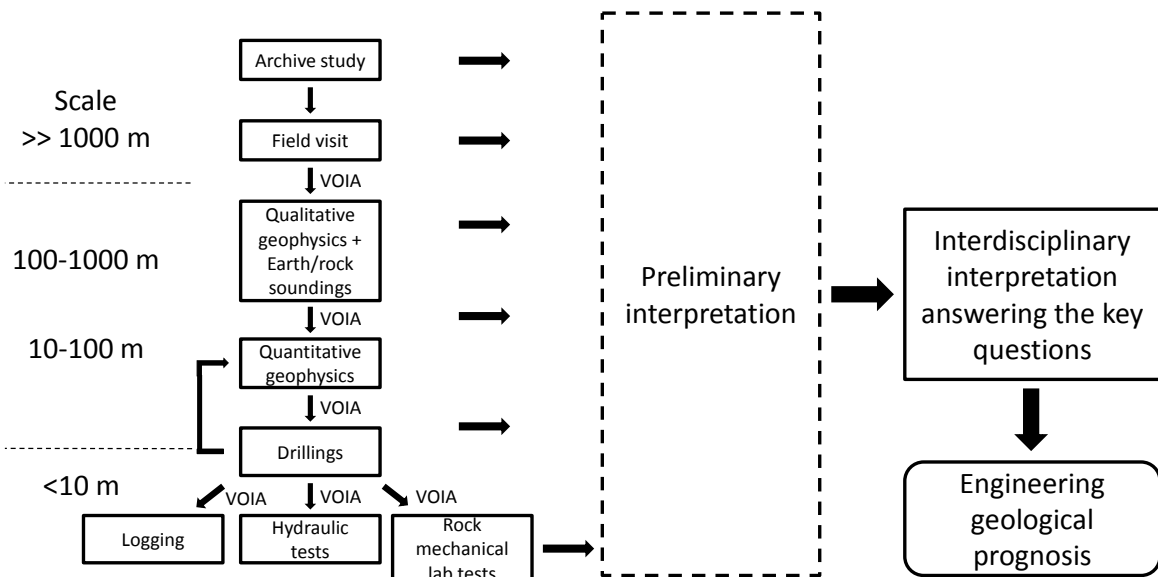

Figure 3.2. A diagram with the optimal flow in a pre-investigation program.

The pre-investigation should be seen as a dynamic process where it is important after each step to make a preliminary interpretation of all information. The framework for VOIA presented in this thesis should be made prior to additional measurements in order to evaluate the value of more detailed investigations and thereby get a more optimized pre-investigation. When all essential information is gathered an interdisciplinary interpretation answering the key questions should be carried out and based on this the engineering geological prognosis should be established as an aid for making the main decisions.

Through the entire project it is important to integrate all material and not forget the previous investigations. For example in the actual construction stage the geological prognosis, and with this also the geophysical data, can be evaluated against the true conditions, which will provide fundamental references and valuable experience to be used in further interpretation and evaluation. Thus it is essential at all stages to review the geological prognosis and continuously update and modify it when necessary.

In larger projects with several different contracts it is recommended that the reports presenting the results from the pre-investigations be structured in a consistent way. It is of great importance that the natural flow in the pre-investigation is kept in the report presenting the results for the client. Thus the results are presented top-down with large scale information prior to small scale. It is necessary for the client (project owner) to set some requirements and instructions for how the reports should be made.

4 Applied geophysics in rock tunnel construction

Applied geophysics can contribute to solution of most geotechnical engineering and environmental engineering problems. Geophysical methods measure the contrast in the physical properties of the sub-surface. Thus the condition of the rock mass is presented in a composite form by the geophysical data set. No interpretation is done when raw data are measured, but is mainly done during and after the processing of the data. Most geophysical methods do not directly measure the parameters useful for the project owner, engineer or contractor. For the interpretation of data, background information concerning the geological setting is required because of ambiguity and variability in the physical properties of the rocks. The physical properties are interpreted in terms of geology which in some cases even allows an assessment of the rock mass quality. For some geophysical methods the data output is of direct significance. An example is seismic methods where the p-wave and s-wave velocity are useful mechanical properties and parameters. However, it is often not the physical property itself that is of interest but the spatial change and variation in the property. Different geophysical methods have different advantages and limitations so before they are used in an engineering context the problems to be addressed have to be resolvable by the chosen geophysical method.

Several geophysical methods are suitable for continuous measurements which can give a 2D or even 3D model of the sub-surface. Thus the geophysical methods can be an important part at different stages of a project. The scale at which the measurements are done has to be tailored to match the degree of detail demanded by the actual stage of a project. In the early stages of pre-investigation large scale measurements are important whereas core drillings provide detailed point information and in situ reference data in later stages. Thus the resolution is lower for large scale geophysics than for core drillings but the continuous measurements provide an interpreted physical image of the variation in the physical properties of the rock mass.

Only a short description of the theory behind the geophysical methods used in this thesis is described in the following chapter, i.e. the geoelectrical method and borehole geophysics (natural gamma, caliper, long/short normal resistivity). Several other geophysical methods are useful in tunnel construction or other types of construction in rock. For more information see Butler (2005), Danielsen (2007), Parasnis (1986), Reynolds (1997), Rønning (2003), Stanfors et al. (2001), Sturk (1998), Takahashi (2004) and Takahashi et al. (2006).

4.1 Geoelectrical imaging

Geoelectrical imaging is one of the geophysical methods that has proved to be important at a large scale, especially for pre-investigations at the feasibility stage (Cavinato et al., 2006; Dahlin et al., 1999; Ganerød et al., 2006; Rønning, 2003; Stanfors, 1987). Geoelectrical imaging at small scale can be done between two or more boreholes, the so called Electrical Resistivity Tomography (ERT). In this study ERT measurements are done in and between boreholes. It can be noted that 2D resistivity imaging based on surface measurements (CVES) is also sometimes referred to as ERT. ERT in vertical boreholes has proven useful for environmental studies (Daily et al., 1995; Daily and Owen, 1991; Deceuster et al., 2006; Denis et al., 2002; French et al., 2002; Goes and Meekes, 2004; Guérin, 2005; LaBrecque et al., 1996). The method has also been demonstrated in boreholes drilled during geotechnical pre-investigation of a tunnelling site to obtain a 2D image of the resistivity close to a

tunnel boring machine (TBM) (Denis et al., 2002). Only a brief introduction to the geoelectrical imaging is given here. For more information see e.g. Binley and Kemna, 2005; Parasnis, 1986; Reynolds, 1997; Takahashi, 2004.

Geoelectrical imaging is a relative fast and cost efficient method compared to other profiling methods, e.g. seismic refraction. In order to correctly interpret the data, knowledge of the geological setting e.g. anticipated lithology and groundwater level from geological maps, cores and borehole geophysical measurements etc. is important.

Geoelectrical imaging is used for measuring the spatial variation in the resistivity of the subsurface. The resistivity of the different geological materials differs greatly from about $10^{-6} \Omega\text{m}$ in minerals such as graphite to more than $10^{12} \Omega\text{m}$ for dry quartzitic rocks, see figure 4.1. Most rock forming minerals are insulators so the resistivity of crystalline rock depends largely on the amount and salinity of water present in fractures and the degree of weathering of the rock. (Binley and Kemna, 2005; Parasnis, 1986).

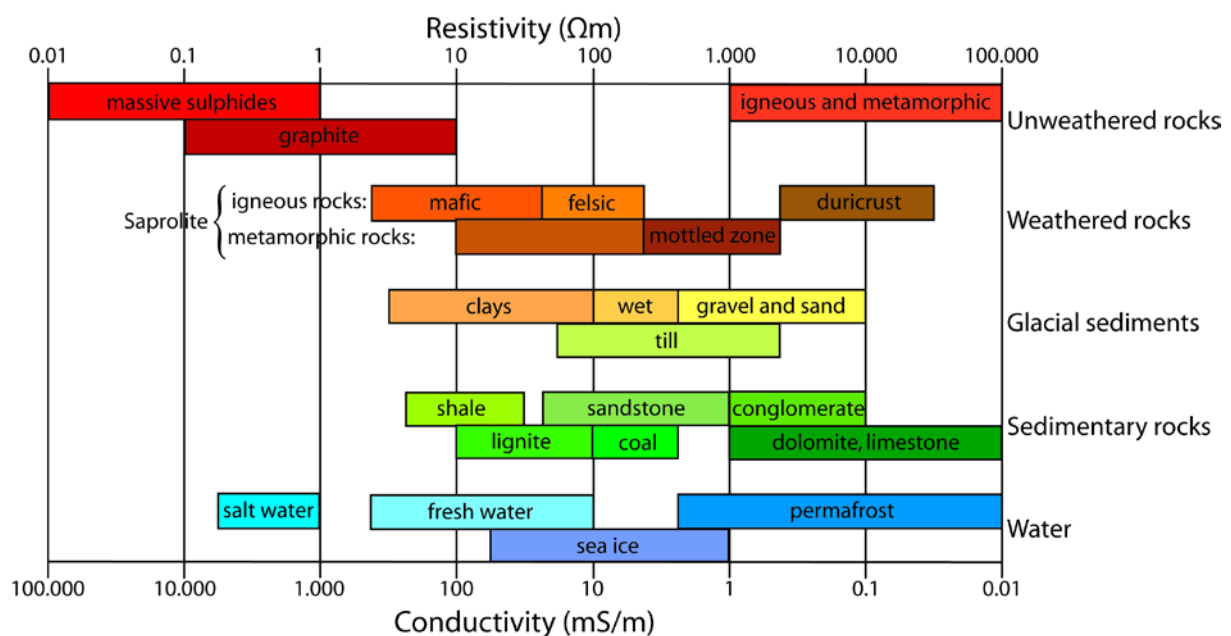

Figure 4.1. Resistivity of different materials measured in Ωm . The reciprocal of resistivity is conductivity which is measured in mS/m . Modified from Palacky (1987).

When electrical resistivity measurements are done, a direct current is transmitted between two electrodes and the potential difference is measured between two other electrodes, see figure 4.2. The measurement results in an apparent resistivity value that depends on the subsurface conditions. The convention today is to perform a large number of four electrode measurements along profiles or over areas to achieve resistivity models as 2D sections or as 3D volumes respectively. This is normally done using multi-electrode systems, i.e. Continuous Vertical Electrical Sounding (CVES). This is a rapid approach for getting information of the spatial distribution of the resistivity in the sub-surface (Dahlin, 1996).

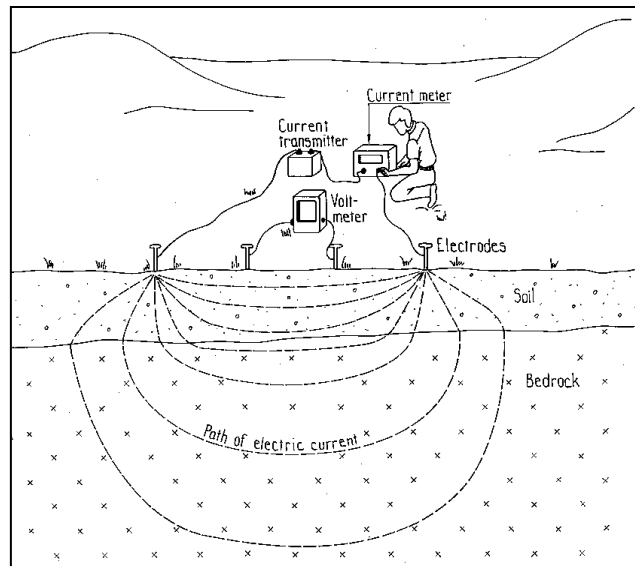

Figure 4.2. Principles of resistivity surveying (modified from Robinson and Coruh, 1988).

For an estimate of the actual resistivity distribution it is necessary to perform inverse modelling on the measured apparent resistivity data (Binley and Kemna, 2005). Techniques for acquisition and interpretation of resistivity data have been developing continuously during the last century.

Generally the depth of investigation of the method increases with increasing electrode distance. As a rule of thumb the penetration depth for the most common arrays is in the range of $L/6$ to $L/4$, where L is the distance between two outermost active current electrodes (Loke, 2004). However this is only the case if the sub-surface is a homogenous which is rarely the case. The current will go through the lowest possible total resistance on the path between the two current electrodes. For example a very low resistive layer near the surface would prevent the current from penetrating deeper into the ground. In this case the resolution of the deeper layer will be limited. In contrast, a very high resistivity layer close to the surface would force the current down to a less resistive layer. The depth of investigation thus depends much on the resistivity of the different layers as well as the largest electrode distance.

Usually the resistivity data are measured as 2D profiles while the subsurface is 3D. Assuming a 2D model can in some cases be problematic when it creates so called 3D effects in the resistivity data, especially if the geology changes on a relatively small scale. In order to obtain the best 2D view, the profiles should be perpendicular to the geological structures. With the development in computer power and data acquisition, 3D surveys are becoming more common, and these do provide a more complete image of the sub-surface.

4.2 Borehole geophysics

For obtaining detailed information from borehole geophysics numerous different logging probes exist. Several of the large scale geophysical methods can also be used in boreholes (e.g. geoelectrical imaging) but there are also additional methods available such as optical televiewer or caliper log. For calibration of the models based on large scale geophysics it is important to remember the difference in scale which may not always make it possible to compare large and small scale data.

Strictly speaking borehole logging is an alternative or supplement to the analysis of drill cores and cuttings. However, core drillings are often preferred because of the possibility of continuous analysis of the rock formation over a given interval, but economic and technical problems limit the use of cores. Coring takes time, and is therefore expensive. A core drilling is about five times as expensive as a percussion drilling (Swedish prices 2010, without mobilization/demobilization (Bjelm, 2010)). In many soft and friable rocks, e.g. in clay weathered rocks it might only be possible to recover part of the interval cored. Geophysical logging gives in situ measurements which are of great value when there is poor or no core recovery. Cuttings, extracted from e.g. percussion drillings, are one of the largest sources of subsurface sampling. However, the reconstruction of the lithological sequence from cuttings is imprecise due to the problem of exactly associating a depth with any given sample. It also demands skilled personnel to determine the lithology and weathering from the small cutting samples. Although most well logging techniques do not give direct access to the rock samples, they do, however by indirect means, provide continuous, in situ measurements of parameters related to lithology and other rock properties of interest (Ellis and Singer, 2007).

If core recovery is poor, borehole geophysics will help clarify if it is due to e.g. weathering or fractures. It is thus important that borehole geophysical data is stored for later re-interpretations. Cores should also be stored, but the moisture will disappear and new fractures may occur. Normally cuttings from the percussion drilled holes are sampled every metre or every third metre and give a useful overall impression of the variations in the borehole. The moisture will also disappear from the cuttings. The borehole geophysics will on the other hand always show the conditions in the borehole when the data was recorded.

In the following a very brief presentation of the different logging probes used in paper 3 and 4 is given. For more elaborate information the reader is referred to literature (e.g. Daniels and Keys, 1990; Ellis and Singer, 2007; Ernstson, 2006; Howard, 1990; ISRM, 1981; Paillet and Ellefsen, 2005; Rasmussen and Bai, 1987; Schepers et al., 2001; Segesman, 1980).

4.2.1 Natural gamma log

Natural gamma logging is a passive logging technique where the natural gamma-ray intensity of the formation along the borehole is measured. The gamma photons are mainly produced by decay of naturally occurring potassium (^{40}K), uranium (^{238}U) and thorium (^{232}Th). For example K-feldspars are radioactive because of the large content of potassium. On the other hand amphiboles and quartz are not radioactive. Thus gneiss is more radioactive than amphibolites (Ernstson, 2006; Nielson et al., 1990). The radioactivity is often measured in count per second (cps).

4.2.2 Caliper log

The three-arm caliper measures variations in borehole diameter with depth. The diameter is determined by three mechanically coupled arms in contact with the borehole walls. The use of a caliper tool to locate fractures requires the fractures to be either open or sufficiently enlarged by drilling, e.g. clay weathered rock can be washed out, to permit a change in borehole diameter to be detected by the tip of the caliper arm (Howard, 1990). The measurements are done when the tool is pulled up the borehole. The caliper probe is equipped with a gamma detector for depth matching. The borehole diameter is given in mm.

4.2.3 Long/Short Normal Resistivity log

The resistivity log is the oldest logging method and was first used in 1927 by the Schlumberger brothers and H. Doll (Ellis and Singer, 2007). The measured physical property is the same as for geoelectrical imaging (Chap. 4.1). There exists several different instrument setups but in this thesis the short and long normal resistivity logs are used. The probe has a current and two potential electrodes with different intervals of 16" (short) and 64" (long). The distance between current and potential electrodes determines the depth of penetration. The larger the distance between the electrodes, the deeper into the formation the current can penetrate which also depends on the resistivity of the rock. The drawback with the larger penetration depth is that small zones are not detected. Water is necessary in the borehole for the measurements to be performed and they cannot be done in cased boreholes (Parasnis, 1986). The probe is equipped with a gamma probe for depth matching.

5 Geoelectrical methods applied at Hallandsås Horst, Sweden

In the following sections examples are given on the applicability of geoelectrical methods and other geophysical data at different scales (Chap. 5.2–5.4) and for different purposes. The natural flow in pre-investigation is top-down thus the investigation begins with large scale measurements and continues into more and more details. All the data presented in this chapter and in the papers originates from the Hallandsås Horst, Southern Sweden (Fig. 5.1), where a 7 km long geoelectrical imaging profile measured along the tunnel in 1998 gave important information about three large weak zones (Fig. 2.6). However, additional geoelectrical and ground based magnetic measurements were performed within this research project (Chap. 5.2, paper 1) with the purpose of answering some of the key questions (Tab. 3.1) and thus make a more reliable geological model by combining different geophysical methods. This was done in a more detailed scale (10–100 m) than the 1998 measurements. By performing geoelectrical measurements between two horizontal boreholes (Chap. 5.3, paper 2) data at a smaller scale (<10 m) were obtained. However the purpose of this work was mainly to develop a methodology for measuring in horizontal boreholes at an actual construction site. Geophysical borehole logging (Chap. 5.4 and 5.5, paper 3 and 4) uses different geophysical methods for providing information in an even smaller scale (<1 m). The information can be used for calibration of the results from the surface geophysics and increases the reliability of the engineering geological prognosis. In chapter 5.5 and paper 4 the search for an explanation to ambiguous resistivity readings has made it necessary to investigate at even finer detail (mm-scale). During the different stages in a project it is essential to have a dynamic process where the engineering geological prognosis is continuously updated when new information is obtained. Therefore the data measured in 1998 is re-processed and compared with the tunnel documentation (Chap. 5.6) in order to learn from the tunnel construction and use that in the following construction work. The experience from the work with the geoelectrical method at the Hallandsås Horst is a natural basis for estimating the probabilities used in the VOIA in chapter 6.

Even though the Hallandsås Tunnel is under construction all data presented in this chapter should be seen as part of a pre-investigation. From a research point of view the advantage with the project is that there exist large amounts of data for correlation. In the following, only the main results from paper 1–5 is shown and discussed, and the reader is referred to the papers for further details.

5.1 Geological setting

The Hallandsås Horst, located in Southern Sweden (Fig. 5.1), is the result of a tectonic activity that has been ongoing since Silurian times. The uplifted blocks have a NW-SE orientation and occur in the Tornquist Zone. This tectonic element stretches all the way to the Black Sea (Wikman and Bergström, 1987). The Hallandsås Horst is 8–10 km wide, 60–80 km long and reaches an elevation of 150–200 metres in the tunnel area.

Crystalline Precambrian rocks and gneisses presumably of intrusive origin compose most of the bedrock, whereas sedimentary rock covers minor areas. Amphibolites of several generations occur where the oldest often are seen as minor layers or schlieren parallel to the layering in the gneisses. The younger amphibolites have distinct contacts and cross cut older structures. These younger dykes are commonly oriented in a NNE-SSW direction (Wikman and Bergström, 1987).

The bedrock is also intruded by a set of younger dolerite dykes with their trend parallel to the Scanian horsts (Wikman and Bergström, 1987). These dolerite dykes are seen as very distinct linear positive anomalies on the aeromagnetic map (Swedish Geological Survey, 1981). On the aeromagnetic maps it is even possible to see a NNE-SSW and NE-SW oriented fracture systems because they disconnect the positive anomalies associated with the dolerite dykes. The dominant fracture system is oriented in NW-SE direction corresponding to the Tornquist Zone. Another distinct fracture system has a NNE-SSW direction and is younger than the NW-SE system. Substantial deep weathering of the bedrock began during Triassic and continued periodically during the Cretaceous and to the present day. This resulted in weathering of bedrock to mainly kaolinite. The weathering is documented in drill cores from the area (Wikman and Bergström, 1987).

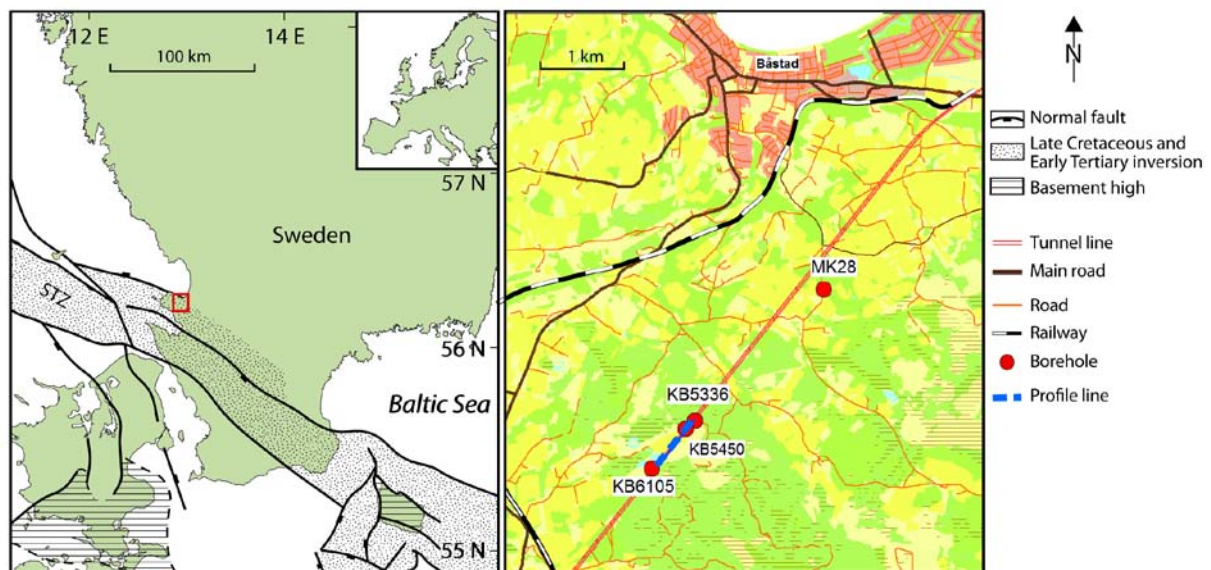

Figure 5.1. Left: Map of Southern Sweden showing the position of the investigated area and the outline of the Tornquist Zone (STZ). Right: Map of northwestern part of the Hallandsås with position of the core drilled holes KB5336, KB5450, KB6105 and the percussion drilled hole MK28. The CVES/IP profile is measured between KB5336 and KB6105. Maps are modified from Graversen (2009), Lantmäteriverket (2001) and Liboriussen et al. (1987).

5.2 Geoelectrical and IP imaging used for pre-investigation at a tunnel project

At the Hallandsås Tunnel geoelectrical and induced polarization (IP) measurements have been performed together with ground based magnetic measurements as part of this research project. The purpose of the investigations was to follow up on the geoelectrical data measured in 1998 and do a more detailed study of the selected area. By this some of the key questions regarding rock type, weathering/rock cover and water should be answered. The work was presented as a conference proceeding *Geoelectrical and IP imaging used for pre-investigation at a tunnel project* (paper 1).

A 900 metre long resistivity and IP profile was measured using the pole-dipole array to obtain a larger median depth of penetration (Fig. 5.1). The measured data was inverted in the program Res2dinv using robust inversion. The magnetic profiles cover only 480 metres from $x = 400$ to $x = 880$

(Fig. 5.2). Two existing core drillings (KB5336 and KB5450) as well as geological maps were available as reference data.

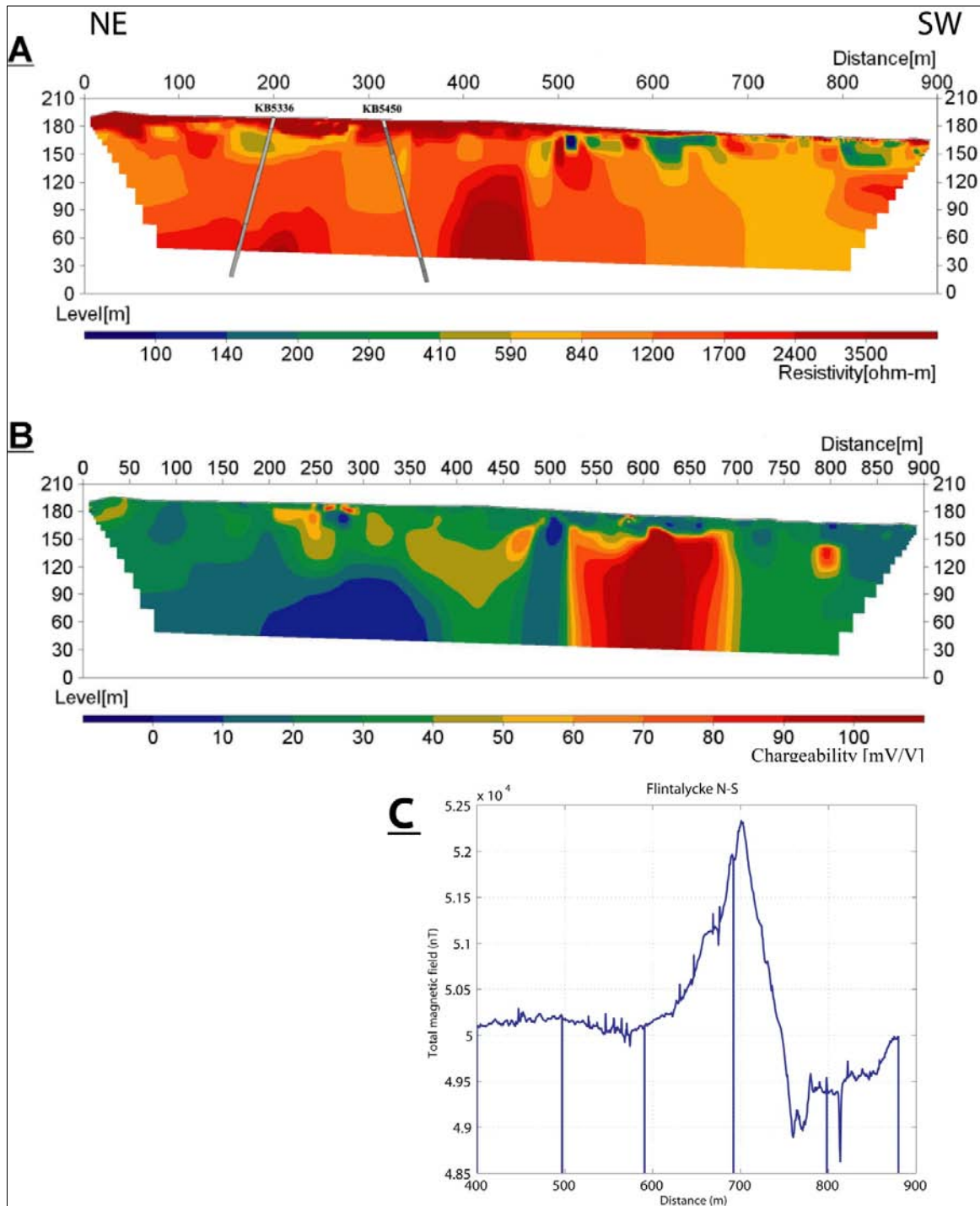

Figure 5.2. (A) Inverted resistivity results for the 900 metre profile. The positions of two existing core drillings are marked in the profile. In (B) the inverted IP can be seen and in (C) the result from the magnetic measurement is shown.

The resistivity, IP and magnetic measurements can be seen in figure 5.2. Based on the resistivity data the investigated area can be divided into two sections. The northern most has a higher resistivity due to fewer fractures and the southernmost has slightly lower resistivity and more fractures. The IP and magnetic data adds information on a dolerite dyke occurring in the area and locates it with high

precision (± 5 m). If the position should be even more precise, modelling of the magnetic anomaly could be done. The dolerites in the area are known to contain high amounts of water in the fractures in the contact to neighbouring rock (Wikman and Bergström, 1987), thus the location of the dolerite is important with respect to water content. Combined with reference data from core drillings (Tab. 1 in paper 1) and general information about the geological setting a geological model is compiled (Fig. 5.3). By combining the different types of data a more detailed and reliable geological model can be compiled and the key questions answered.

Unfortunately the boreholes were drilled prior to the geophysical survey, and thus the boreholes are not positioned optimally for the present study. However the information from the boreholes still contributes with information about e.g. lithology and fracture frequency. With the borehole information the uncertainty of the geological model is reduced, but could have been further reduced if the boreholes would have contributed with information from the area at $x = 600$ m where there is a high IP effect.

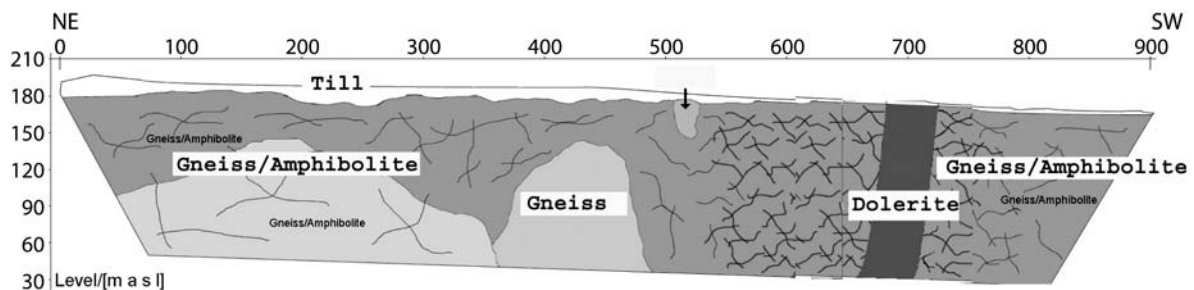

Figure 5.3. Detailed geological interpretation of the 900 metre profile.

When new information is obtained the geological model should be evaluated and updated if necessary. Thus the geological model in figure 5.3 should be updated with the information from the geophysical logging of KB5336 (Fig. 5.5). The geophysical logging (Fig. 5.5) confirms the low resistivity ($<600 \Omega\text{m}$) at a depth of 40 metre (160 m.a.s.l.) which is due to fractures and weathered rock. Below this depth the rock is less fractured which is also reflected by higher resistivity to a depth of 120 metre (70 m.a.s.l.). Beneath this depth the borehole geophysics shows that the rock is highly fractured and weathered. As a consequence the geological model can at this depth be updated to contain fractured and weathered gneiss/amphibolite. The borehole geophysics is measured to below the tunnel level and can therefore contribute with information where the geoelectrical imaging is more uncertain due to lower resolution. That the rock is more fractured and weathered at tunnel depth is important information which would have been overlooked if only the geoelectrical imaging was used. So by adding the information from the detailed borehole geophysics the uncertainty in the interpreted geological model is reduced. If possible a joint inversion (modeling) of all types of data would be ideal.

Geoelectrical and IP imaging in combination with ground based magnetic measurements and geophysical and geological borehole information are useful in the design/production planning stage for compiling a geological model of the subsurface. The continuous geophysical measurements should be performed prior to drillings with the purpose to make a targeted and optimized drilling campaign and perhaps even reduce the number of drillings.

5.3 Numerical modelling of resolution and sensitivity of ERT in horizontal boreholes

Resistivity measurements in horizontal boreholes can give useful detailed information about the geological conditions for construction in rock, i.e. in front of a tunnel boring machine. This paper attempts to identify a suitable methodology for this type of geophysical measurements for an effective measuring routine under actual construction site conditions. The results from this study can be seen in the paper titled *Numerical modelling of resolution and sensitivity of ERT in horizontal boreholes* in paper 2. ERT is an abbreviation for Electrical Resistivity Tomography.

Prior to any measurements numerical modelling was done in order to evaluate the resolution of four different electrode arrays and a combination of the arrays. The sensitivity to inaccurate borehole geometry and the influence of water in the boreholes was also investigated.

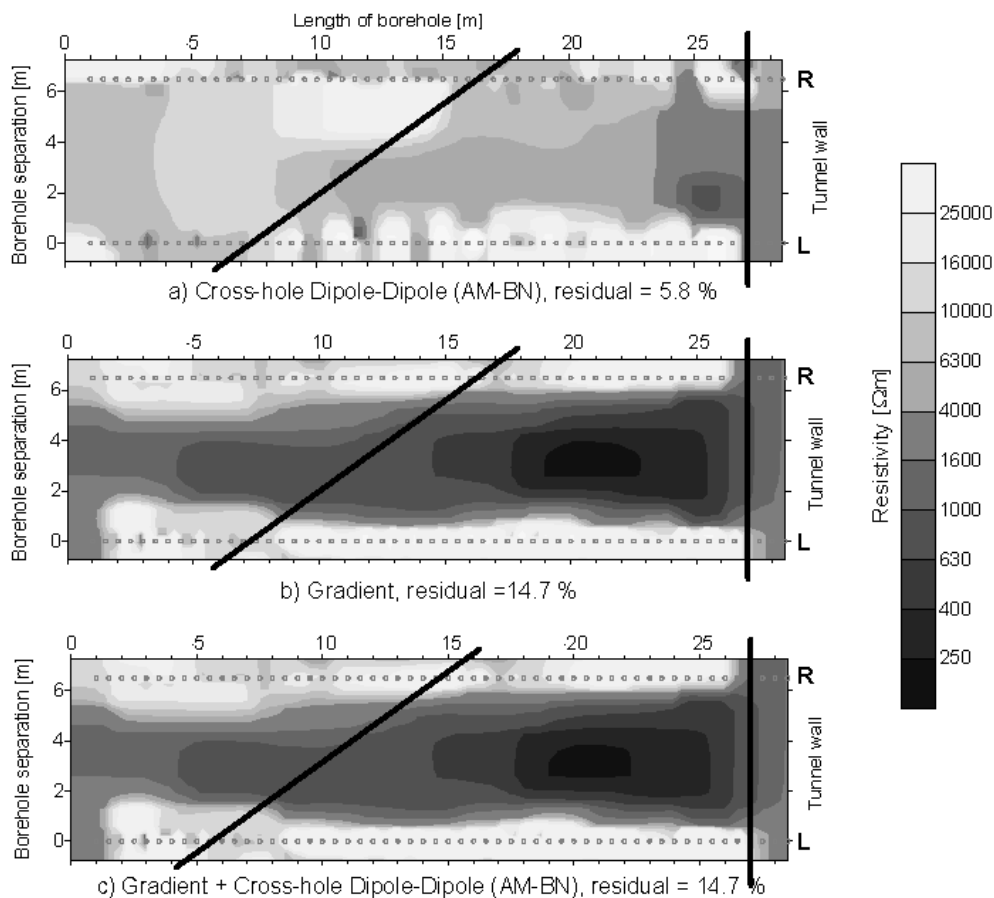

Figure 5.4. The inversion results in a greyscale from the resistivity measurements using different electrode arrays. The boreholes are seen from above with the tunnel wall to the right in the figure. The left borehole, seen from the tunnel, is marked with **L** and the right borehole with **R**. The heavy black lines show probable structures. a) Cross-hole dipole-dipole array, b) Gradient array, c) Combination of gradient and cross-hole dipole-dipole. Grey circles mark the position of the electrodes. The electrode separation is 0.5 metre.

Based on the model study the AB-BN array, multiple gradient arrays and a combination of these were found to give the best result and therefore were used for test measurements in horizontal boreholes. The boreholes were 28.5 metre long and drilled 6.5 metres apart. Prototypes of semi-rigid borehole cables made it possible to insert multi electrode cables in an efficient way, allowing fast

measurement routines. These measurements were then studied to determine their accuracy and applicability.

Unfortunately the boreholes used for the test measurements were not core drilled so no direct information was available for the interpretation of the data. Instead the indirect information from a horizontal core drilling, called NA01, drilled perpendicular to the test holes was used (Fig. 11 in paper 2). The drilling report (left out here) showed that where it crosses the two test boreholes the lithology is gneiss. The geological structures here intersect the tunnel at an angle of 65–70°. This information together with the data from NA01 gives a rough estimated position of fractures and formation changes in the test boreholes.

By comparing the measured result (Fig. 5.4) with the estimated position of the structures found in NA01, it is clear that no fractures are resolved by the resistivity method. The fractures may be too narrow to be resolved or the resolution of the data may be insufficient. The data are most likely also influenced by 3D effects.

The transition from high resistivity to lower resistivity is interpreted as a change in lithology from gneiss-granite to gneiss. The mineral composition of the rock mass is different and probably most important is that the gneiss-granite contains fewer fractures than the gneiss (Wikman and Bergström, 1987). This probably explains why the gneiss-granite has a higher resistivity than the gneiss. The low resistivity zone close to the tunnel wall is most likely caused by the shotcrete at the tunnel wall, which contains steel fibre reinforcements. In addition there might be rock reinforcements, e.g. rock bolts, which could affect the result. In an actual production phase shotcrete and rock reinforcement will not influence the measurements when performed in the tunnel front because they will not yet have been applied.

An important outcome of this study was that the prototype of the semi-rigid cable proved to work well. For production measurements it is suggested that electrode cables with an integrated glass fibre rod would work well. Measuring of reciprocal data for data quality assessment is suggested at least in a test and development phase. For a better data evaluation it would be worthwhile to obtain accurate reference data by making measurements in core drilled boreholes so that the resistivity results can be compared to the borehole logs. A further optimization of the protocol files is also vital, and in particular a study of the different 2D sensitivity patterns is considered to be essential. It would be interesting to do the measurements between more than two boreholes and to reduce the distance between the holes. In this case 3D inversion would be useful.

5.4 Borehole geophysics provides detailed information in pre-investigation for rock tunnel construction

The scope with this paper is to show that borehole geophysics can give detailed information of lithology changes, fractures and weathering of crystalline bedrock. The work is presented in the paper *Geophysical logging for enhancement of borehole information in pre-investigation for rock tunnel construction* (paper 3).

In two core drilled boreholes at the Hallandsås Horst, geophysical logging was performed in order to evaluate the resolution and usefulness of the method. For evaluation the logs were compared with

the cores. The result suggests that logging of non-cored boreholes potentially reveals very useful information especially when there are a few cored drill holes to correlate with. As an example geophysical logging was done in a percussion drilled borehole in the same area. The experience from the logging in the core drilled holes was then used for the interpretation. Only the result from the logging of KB5336 will be shown here in chapter 5.4. For the results from the logging of KB6105 and MK28 the reader is referred to paper 3.

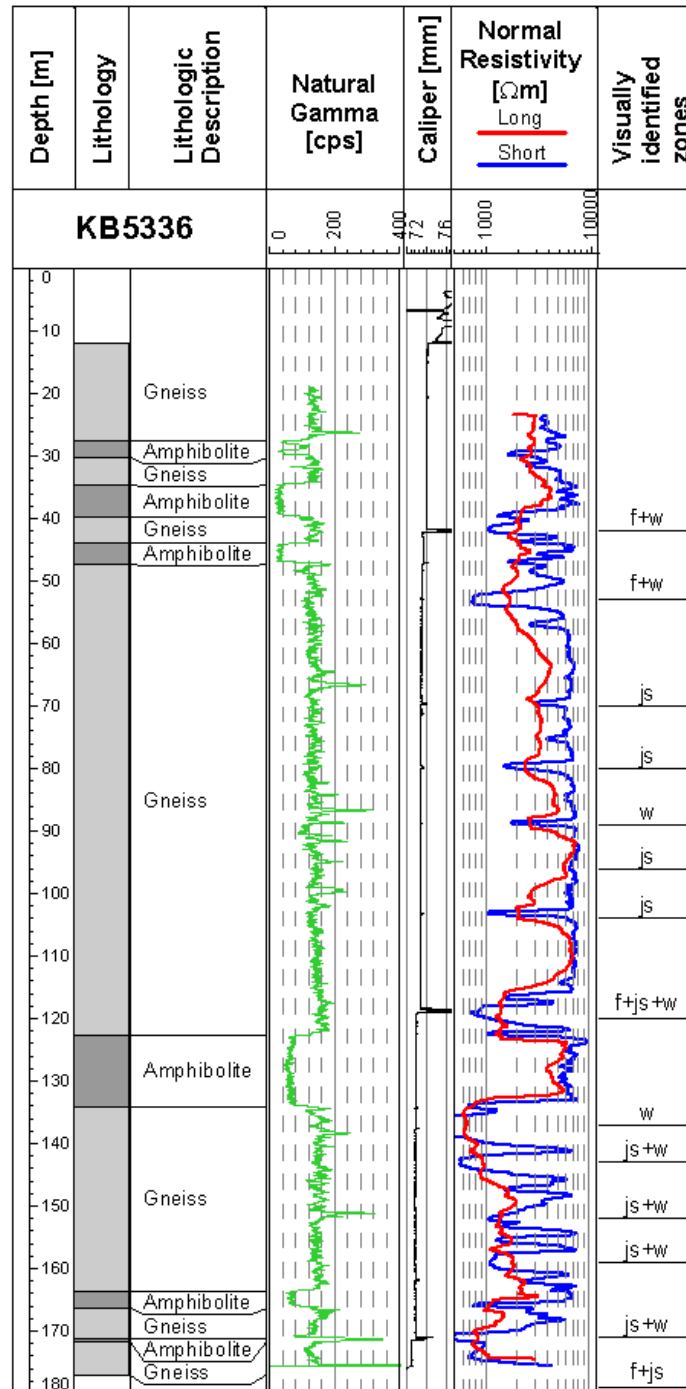

Figure 5.5. Lithological and petrophysical logs of KB5336. The identified occurrences are abbreviated fracture (f), weathering (w), joint set (js).

In KB5336 (Fig. 5.5) the natural gamma log show lower counts in the amphibolite than in the gneiss. The caliper log shows several irregularities where the diameter of the borehole increases in a short interval. These intervals coincide with the intervals where the short resistivity log has low resistivity. Examples are at 53 m, 80 m and 104 m where especially the short resistivity log has large divergences. The resistivity differs between 10 Ωm and 10 000 Ωm . In the first 120 m of the borehole the resistivity is mainly high (10 000 Ωm) but with narrow areas with low resistivity (1 000 Ωm). Below 134 m the short resistivity log changes character and is dominated by lower resistivity (<1 000 Ωm). The visual observations showed that the low resistivity intervals coincide with fractures and/or joint sets. The fractures are often clay filled due to weathering. The high resistivity coincides with intervals with fresh rock without any fractures. The change in the behaviour at 134 m (Fig. 5.6A) was clearly due to higher fracture frequency and even a second fracture direction. The photograph in figure 5.6A shows an example of fractures, joint sets and clay weathering in KB5336 at 135 m. In figure 5.6B the fresh amphibolite in KB6105 at 88 m is seen.

From the logging in the core drilled boreholes the obtained experience can be used when interpreting the logging results in the percussion drilled borehole. The visual inspection of the cores from KB5336 and KB6105, illustrated by the photographs in figure 5.6, shows clearly that fractures, joint sets, weathering and in some cases even lithology change can be identified by geophysical logs in crystalline rock. Generally KB6105 contains less fractures and weathered zones than KB5336 which is seen in a steadier resistivity and calliper log signal. Only a few joint sets and weathered zones were observed in KB6105. With the experience from the core drilling in mind the interpretation of the logging result of the percussion drilled MK28 becomes more detailed and less uncertain.

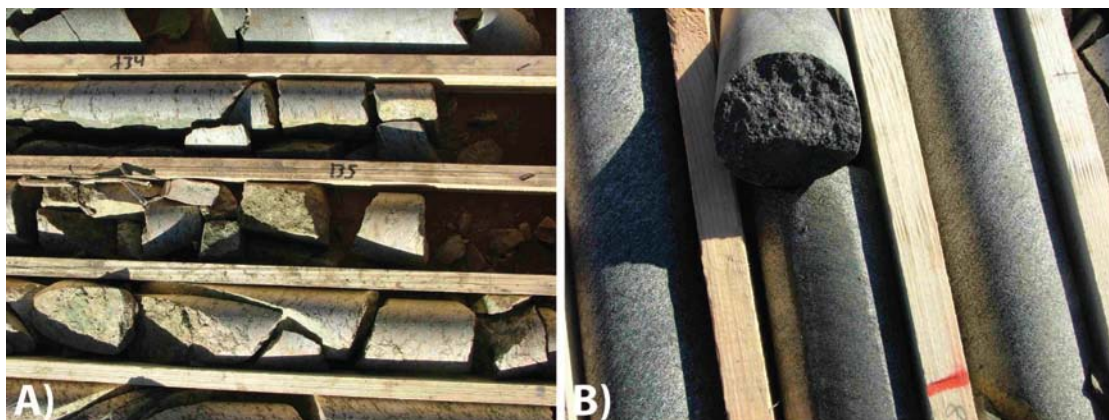

Figure 5.6. A) KB5336: highly weathered and fractured rock at 135 m. B) KB6105: fresh amphibolite at 88 m (the author broke the core in order to take a sample).

The different logs respond to different physical properties and in this case the three types of geophysical logs have the following characteristics:

Natural gamma: Low count when the lithology is amphibolite or dolerite and high count when the lithology is gneiss. The gneiss contains potassium rich minerals as K-feldspar and biotite and thus the gamma log has a higher count in these parts. This is regardless of fractures. It is however not possible to distinguish between amphibolite and dolerite, because mineralogically they are similar but with different texture.

Caliper: Increased diameter in a limited interval indicates fractured rock and the wider peaks are joint sets and weathered zones.

Normal resistivity: Low resistivity (800–2 000 Ωm) indicates where the rock is fractured and/or weathered. A high resistivity (>6 000 Ωm) indicates a homogeneous rock.

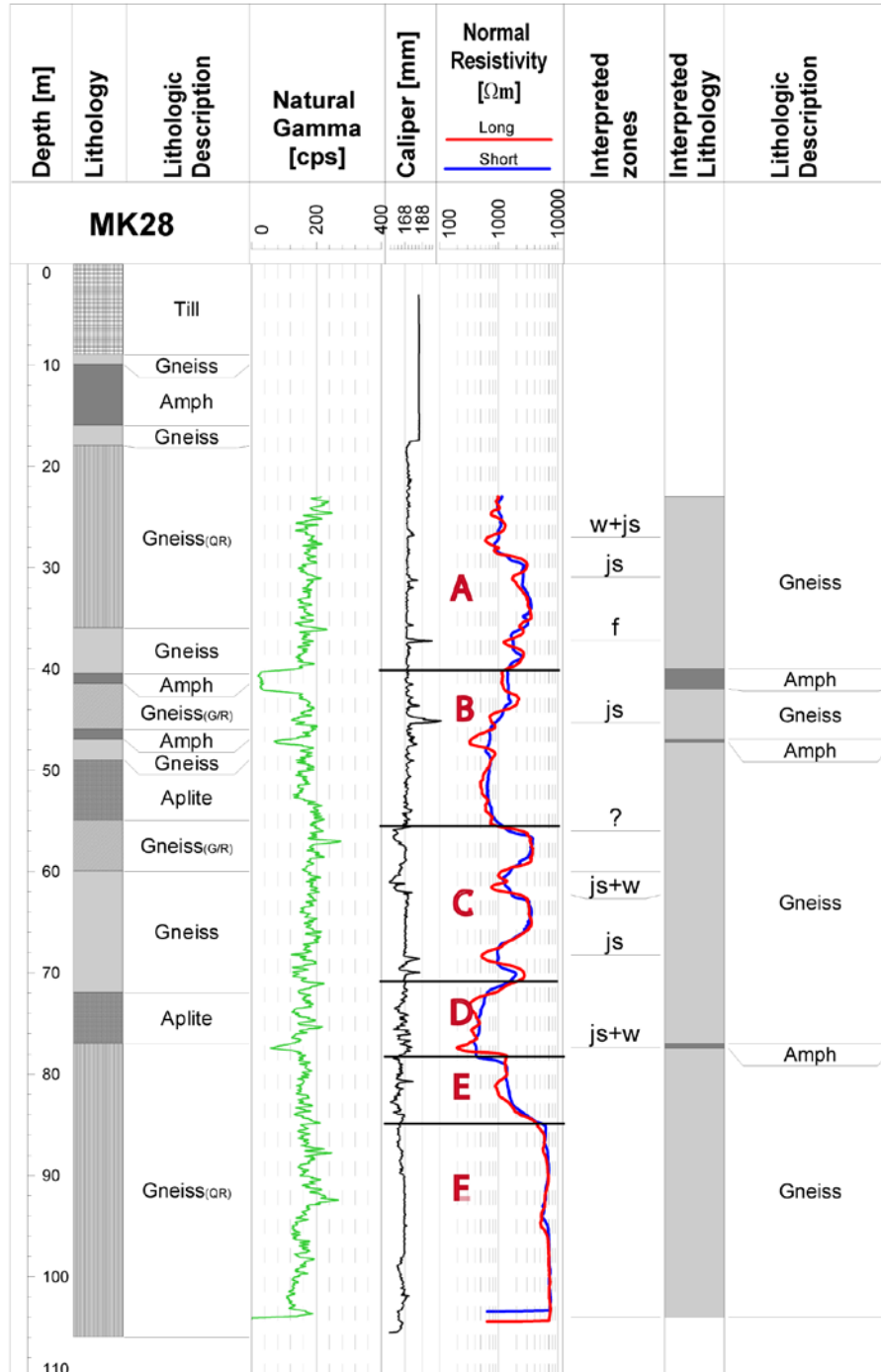

Figure 5.7. The geophysical log and interpretation of the percussion drilled borehole MK28. The lithology to the left is the observations from the drilling of the borehole. The lithology to the right is an interpretation based on the gamma log. The interpreted occurrences are based on the caliper and the resistivity log and are abbreviated fracture (f), weathering (w), and joint set (js). Additionally the caliper and the resistivity log are divided into six zones, A to F, based on their different characteristic.

With this in mind the logging result of the percussion drilled borehole MK28 (Fig 5.7) can be interpreted with a higher degree of certainty.

A lithological description done at the drilling site is relatively detailed and is based on the drill cuttings (< 2x2 cm). This demands a very skilled driller and/or geologist at the site. Thus there might be some uncertainties in the determination of the lithology and the position of the different lithological contacts. An advantage with logging is that it is in situ measurements and that the data is recorded, so that any ambiguity in the result it can be viewed by more than one person. In MK28 some inconsistencies exist between the depth and presence of amphibolite/dolerite. Because logging is in situ measurements the gamma log gives a precise position and thickness of the amphibolites/dolerites. It is obvious that the discrepancy is due to the difficulties of determining the correct depth from cutting samples.

Due to the drilling method used in MK28 the caliper log has much larger variations than the core drilled boreholes. Consequently the log detects more fractures and irregularities. Some of these could have been introduced by the drilling method. Combined with the resistivity log, the location of the fractures and weathered zones becomes more certain. In those parts where the caliper log shows a larger borehole diameter and simultaneously the resistivity is decreased there is probably a fractured/weathered zone.

The division of zones in MK28 (Fig 5.7) helps in characterizing the rock, with a different character in each zone. It can be expected that the rock has different mechanical properties in the six zones. The properties in the different zones are summarized in table 5.1.

Table 5.1. The characteristics of the six different zones A-F in MK28.

Zone	Characteristic
A	Few fractures
B	Several lithology contacts – might contain water
C	Changing quality
D	Very fractured + weathered – lithology change
E	Fractured + weathered
F	No fractures

Borehole geophysics can contribute with information about lithology, structural and rock mechanical properties. The borehole geophysics can also be used to calibrate the results from surface geophysics and should therefore be an integrated part at all stages in the pre-investigation. It can be recommended that borehole geophysics is done in the cheaper percussion drilled holes and thereby be a good alternative to the expensive core drilled holes. The logging probes used in the three boreholes is generally standard and part of most logging equipment. They provide useful information but additional logging probes could be used to give additional information. For example the sonic log that involves high frequency P-waves or acoustic waves can be used to obtain a detailed velocity profile along the borehole. The velocities of P- and S-waves obtained can be used to calculate the dynamic modulus of elasticity (Takahashi et al., 2006). Another logging probe which could be used with great advantage is the optical televiewer. The optical televiewer provides a continuous and

oriented image of the borehole wall. This gives information about fracture condition, orientation, dip and strike as well as a visual image of the rock surrounding the borehole (Paillet and Ellefsen, 2005).

5.5 Geophysical logging as a tool for identifying initial weathering in crystalline rocks

Even though the logging of a cored drill hole gives many answers, there are however unanswered questions and it can become necessary to go into even more detail to get a clear answer.

The scope of this paper is to show how even low degrees of weathering of rocks affects the geophysical log response, by means of microscopy, point counting and logging. This was done on gneisses and amphibolites from two drill cores from the Hallandsås Horst. The work is presented in the paper *Geophysical logging as a tool for identifying initial weathering in crystalline rocks* (paper 4).

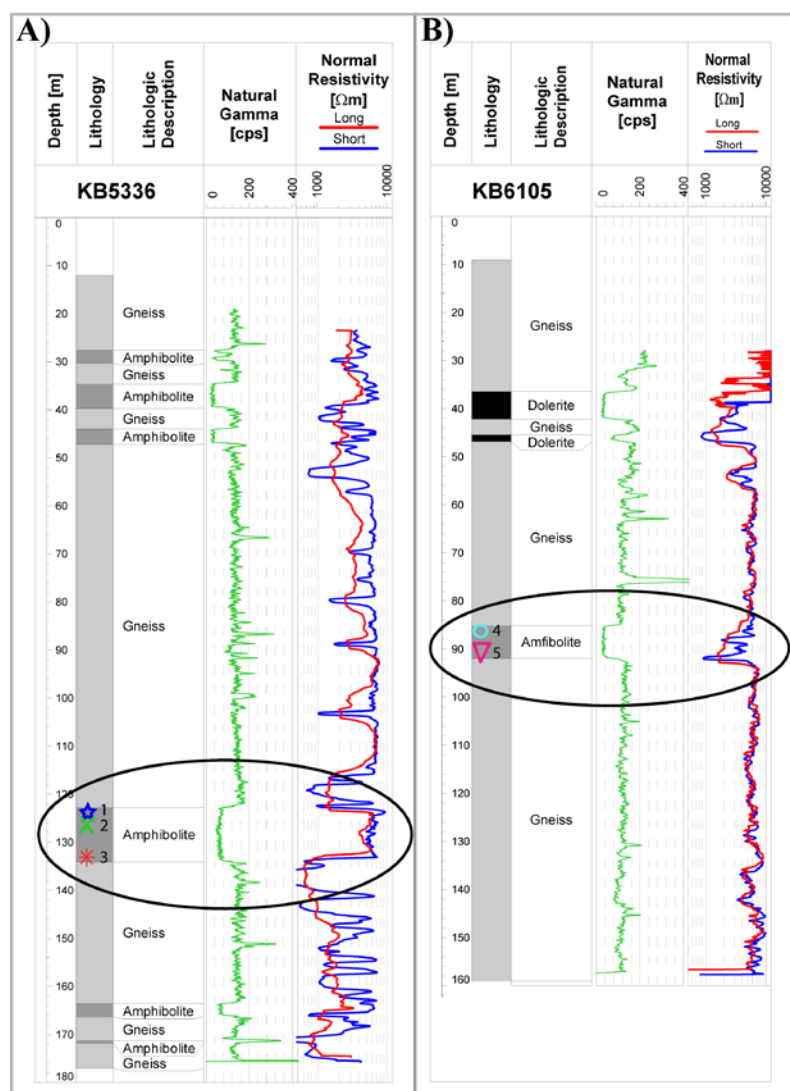

Figure 5.8. Lithology, gamma and resistivity logs for A) KB5336 and B) KB6105. The investigated amphibolites are highlighted with a ring. The positions of the samples are marked with the symbols used in figure 5.10.

The original cores were placed on the ground in one succession and afterwards inspected visually. The core observations and details in the rock classification were documented by photographs, (Fig. 5.9). Finally, representative samples of the different rock types and rocks with unexplained resistivity anomalies were taken for thin sections.

The geophysical logging is supported by microscopy and point counting to evaluate the weathering stage and to quantify the mineral content. The point counting was done on thin sections by using a point counter and registering the mineral phase for every 0.7 mm in both x and y directions. The accuracy of the point counting ranges from 1 to 3% depending on how common the mineral is. For documentation microphotographs of the thin sections were done at 2.5 times magnification.

The core observations showed that the low resistivity intervals coincide with weathering, fractures and/or joint sets that occasionally were clay filled. The high resistivity corresponds with intervals of fresh rock, both gneisses and amphibolites, without any fractures (Fig. 5.9).

The resistivities of the amphibolites in KB5336 (Fig. 5.8A and 5.9A) are around 7000 Ωm whereas the resistivity of the amphibolite and dolerites in KB6105 (Fig. 5.8B and 5.9B) are around 2000 Ωm . Further the resistivity is constant within amphibolite layers in KB5336 whereas it fluctuates in the amphibolite and dolerite layers in KB6105. The two boreholes are only separated by 770 metre so the large difference in resistivity is ambiguous. In both cases the amphibolites seemed to be fresh with no weathering and only few fractures or joints (Fig. 5.9). The overall theory is that the differences in resistivity in a lithological unit are caused by fractures and/or weathering. No obvious difference in the mineralogy or texture was observed that could explain the large difference in resistivity and can thus be ruled out as an explanation. But why is there a large difference in the resistivities of two apparently similar amphibolites? The visual inspection could not provide an explanation. Is this due to differences in mineralogy of two different generations of amphibolites? Is it conductive microfractures? Or weathering of minerals? Therefore the petrography and the mineral composition were investigated.

No obvious and visual explanations were found during the inspection of the core, thus samples were taken for petrographic investigations. Three samples of the amphibolite from KB5336 and 2 samples of the amphibolite from KB6105 were taken. Additionally, one gneiss sample was taken from each core. The positions of the samples of the amphibolites are shown in figure 5.8.

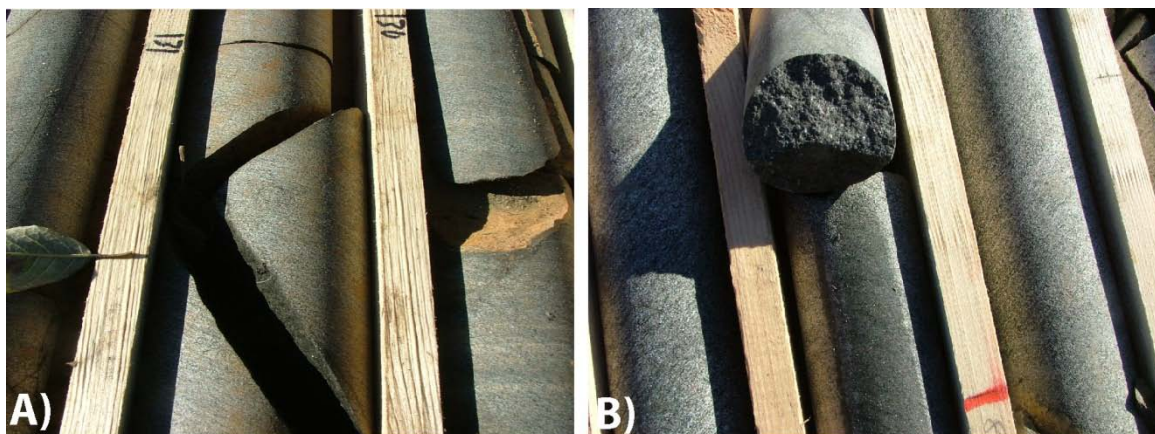

Figure 5.9. A) Unweathered amphibolites with joints at 130 metres depth in KB5336. B) Apparently unweathered amphibolites with no joints from KB6105 at 88 metre.

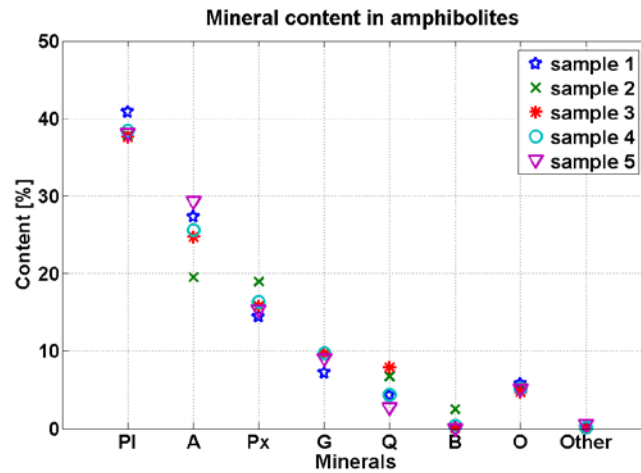

Figure 5.10. The mineral content [%] in the amphibolites. The minerals are abbreviated as follows: plagioclase (Pl), hornblende (A), pyroxene (Px), garnet (G), quartz (Q), biotite (B), opaque (O) and other minerals (Other).

The initial petrographic investigation indicated that all the amphibolites are mainly comprised of plagioclase, amphiboles, pyroxenes, garnet with accessory quartz, biotite and an opaque phase probably low resistive oxides or sulphides (Fig. 5.11). However, the point counting showed very little variance in the mineral content (Fig. 5.10, Appendix A in paper 4). Based on this it can be ruled out that the difference in resistivity of the studied amphibolites is a result of difference in the primary mineral content.

The microscopy of the thin sections showed microfractures in sample 1, 3 and 5. The fractures were probably filled with ironhydroxides or chlorite. Opaque minerals occur as isolated crystals (Fig. 5.11). In sample 4 and 5 several of the pyroxenes appears to be altered (Fig. 5.11B) compared to the pyroxenes in samples 1, 2 and 3 (Fig. 5.11A).

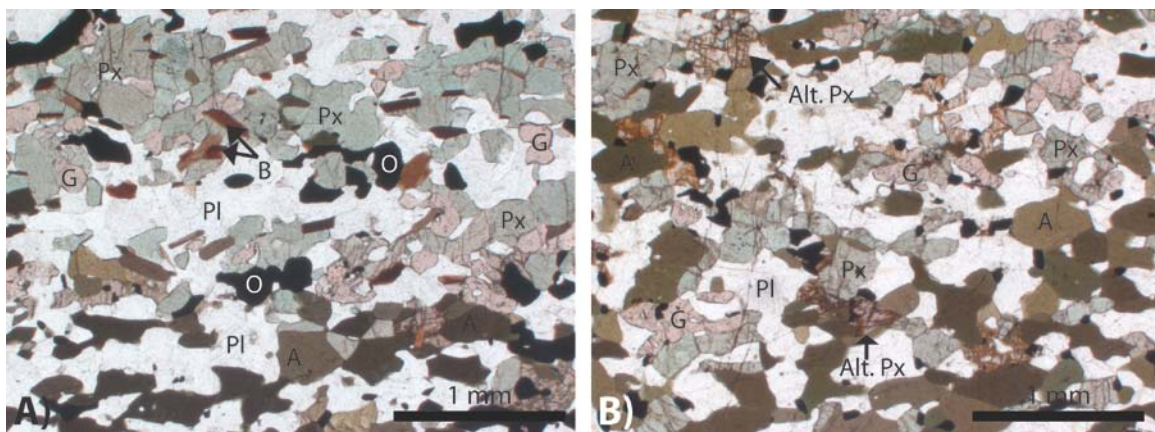

Figure 5.11. Microphotographs of A) an unaltered amphibolite from sample 2 and B) altered amphibolite from sample 5. The minerals are abbreviated as follows: plagioclase (Pl), amphibole (A), pyroxene (Px), garnet (G), quartz (Q), biotite (B), opaque (O) and altered (Alt.).

Oxides and sulphides are conductive minerals and would thus lower the resistivity of the rock (Carmichael, 1989). However, the opaque phase occurs as isolated crystals and therefore is not the reason for the lower resistivity of the amphibolite in KB6105 (Fig. 5.11). If the opaque phase should decrease the resistivity of the amphibolite significantly, it should form an interconnected conducting

network. Such a network could be formed by microfractures probably filled with ironhydroxides and chlorite which are present in the studied amphibolites. However, microfractures are present in both the high and the low resistivity amphibolites and thus can not explain the difference in resistivity.

Initial weathering and alteration on the other hand can explain the lower resistivity of the amphibolites and dolerites in KB6105. This is evident from commonly altered pyroxenes in the amphibolite in sample 5 in KB6105, in particular in the bottom part of the amphibolite. The pyroxenes have clearly been hydrated forming new hydrous minerals along the edge and cleavage planes of the crystals. Hydrous minerals are more conductive than non-hydrous silicate minerals and have therefore lowered the resistivity of the weathered amphibolite. Simultaneously minor hydrous minerals have precipitated along grain boundaries, thus forming a conductive network able to decrease the resistivity of the amphibolite. The weathering was most likely initiated during uplift of the Hallandsås Horst, in this particular case, by introduction of water into the lithological contact between the bottom part of the amphibolite at sample 5 in KB6105 and the underlying gneiss.

This example shows that by going into details an explanation can be given to what seems to be artefacts in the geophysical data. The more knowledge obtained about the ground conditions the better. Even though the alteration of the minerals were not visible to the naked eye, it could become significant for the mechanical properties of the rock.

5.6 Comparison of geoelectrical imaging and tunnel documentation at the Hallandsås Tunnel, Sweden

The results in the previous chapters show that in a pre-investigation geoelectrical imaging and borehole geophysics provide useful information about the rock properties. However it is important to evaluate the data as the project progresses, because by calibrating with e.g. tunnel documentation the interpretation of the geophysical data can become even more certain. Thus the interesting question is: what else can be resolved by geoelectrical imaging? This is investigated in the paper *Comparison of geoelectrical imaging and tunnel documentation at the Hallandsås Tunnel, Sweden* (paper 5).

The evaluation is done by comparing the electrical imaging with tunnel documentation from the completed part of the Hallandsås Tunnel. The documentation includes information on e.g. rock type, weathering, water leakage, RQD and fracturing. (For more information about these parameters the reader is referred to paper 5). The comparison is done merely by visual evaluation of three different sections of the tunnel referred to as North, South and TBM in the following section. The distance between the centrelines of the two tunnels is 25 metre.

In figure 5.12 the tunnel documentation gathered in front of the TBM is compared with the resistivity data from the same section. The mapped data were rock type, RQD, block size, weathering, rock class and water leakage. The resistivity data are shown as the full model and as sub-models extracted at 60 metres and 25 metres above sea level. To make the evaluation of the results easier, different resistivity zones are marked with a letter and a number. The data are divided into three categories i.e. low (L), intermediate (I) and high (H) resistivity. The three categories cover the same resistivity interval in all three tunnel sections. The concept is to focus on the change in resistivity, e.g. from high to low, and not on the specific numerical value of the resistivity.

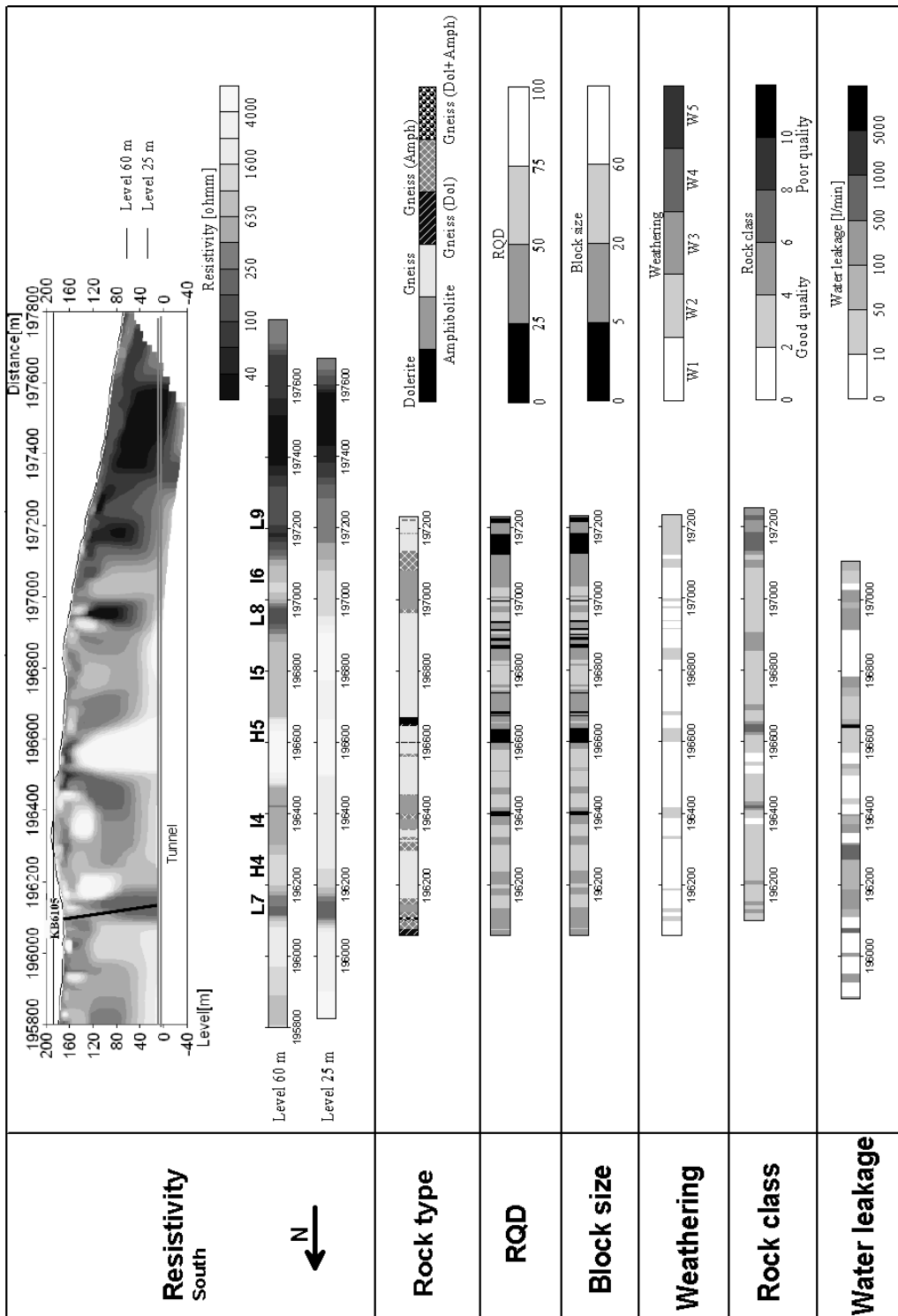

Figure 5.12. Visualization of resistivity and mapped data from the southern part of the Hallandsås tunnel. The mapping is done in front of the TBM at every operational stop. The mapped data were rock type, RQD, block size, weathering, rock class and water leakage. The resistivity data are shown as full model and as sub-models extracted at 60 metre and 25 metre above sea level. The low resistive zones are marked with L7, L8 and L9. High resistive zones are marked with H4 and H5. The areas with intermediate resistivity are marked I4, I5 and I6. Here the tunnel base is at approximately 15 metre above sea level.

In this part of the resistivity section three low resistive zones are identified. Only L7 and L9 are visible in both levels (Fig. 5.12). Two high resistive areas and three areas with intermediate resistivity are detected. In table 5.2 the corresponding properties from the tunnel documentation are summarized.

Table 5.2. Dominant properties of the rocks with corresponding low (L), intermediate (I) and high (H) resistivity sections for the TBM drilled part of the tunnel. The most likely explanation to the resistivity value in the interval is indicated with **bold italics**.

Resistivity	Rock type	RQD	Weathering	Water
L7	Several contacts	25-50	W1	Int. but increased
L8	Gneiss/Amph.	25-50	W1	Intermediate
L9	Gneiss	0-25	W2	No values
H4	Gneiss	25-50	W1	Low
H5	Gneiss	50-75	W1	Low/Very high
I4	Amphibolite	25-50	W1	Int./high
I5	Gneiss	25-75	W1	Int./No values
I6	Amphibolite	25-75	W1	Intermediate

The comparison of resistivity data and tunnel documentations from the Hallandsås Tunnel shows that changes in resistivity in most cases is related to some kind of change in rock conditions (see figure 5.12 and table 5.2 and figure 3 and 4 in paper 5). High resistivity corresponds well with good quality gneiss as the dominant rock type. In general low resistivity corresponds to a varying lithology with several fractured contacts or merely rock with a poor quality (RQD<25). The intermediate resistivity often coincides with areas of amphibolite with an average RQD of 25-75 (fair quality). Danielsen and Madsen (2010) (and chapter 5.5) showed that intermediate resistivity in amphibolite indicate initial weathering of pyroxenes which can be expected to weaken the rock.

The results in figure 5.12 and figures 3 and 4 in paper 5 also show that in some cases the intermediate resistivity corresponds to increased water content. The presence of water can decrease the resistivity of a rock with an otherwise fair rock quality. As an example, very large amounts of water can originate from a single fracture and this is not synonymous with a low RQD. This clearly shows the ambiguity of geoelectrical imaging. Although in most cases there is a correlation between resistivity and rock conditions, there are also exceptions.

A disagreement in correlation between resistivity and rock conditions may have several different causes. The tunnels are only separated by 25 metres and even so there is still a significant difference between the lithology and rock properties documented in the eastern and western tunnels, emphasising the high variability in the rock mass properties. Thus 3D effects in the resistivity data should be expected. Another issue is the difference in the scale of the data. The tunnel documentation shows every small change in the rock conditions. For the resistivity method to be successful a zone has to be sufficiently large and have large enough contrast in the physical properties, otherwise it will show an average of the zones. A complicating factor in this particular tunnel project is that the tunnel is situated at great depth giving poor geophysical data resolution at tunnel level. Lack of resolution can cause a low resistivity body at a shallower depth to apparently extend down to tunnel level. The resistivity data are measured at the ground surface, 120–150 metre above the tunnel. Therefore these data have a much lower resolution at tunnel level than the

detailed tunnel documentation. A zone can be too narrow to be visible in the resistivity data if the resistivity contrast with the surrounding rock is not sufficiently large. Longer layouts and a pole-dipole array would give a larger penetration depth and a better resolution at tunnel level. Furthermore, non-symmetrical arrays, such as pole-dipole and multiple gradient arrays, are better at resolving dipping structures than the Schlumberger and Wenner arrays. The latter tend to image inclined structures as vertical. A drawback, however, is that the field logistics are more complicated. In the mapping of the tunnel there is also the human factor to acknowledge. The mapping of RQD, weathering and lithology is a quasi-subjective assessment done by geologists at the tunnel site. There is no big difference in rock mass properties if the rock has a RQD of e.g. 28 or 23 but it means that the conditions look more serious in the plot intervals used in this study. So the mapping is somewhat subjective and might bias the results in some parts.

For the Hallandsås Tunnel project it was important to get information from geoelectrical imaging for the three large weak zones with problematic rock quality (Dahlin et al., 1999; Sturk, 1998). These main features are unmistakably the most important findings from the geoelectrical imaging at the Hallandsås Horst. However it is probable that more information, useful for construction, can be extracted from the remaining part of the 2D profile. The comparison of resistivity data and tunnel documentations shows that changes in resistivity in most cases are related to some kind of change in rock conditions. It is shown here that the size of the structures resolved is on a scale of tens of metres and that the resistivity values are ambiguous, therefore the interpretation of the results is not always fully correct. Although the ambiguity of the resistivity cannot be resolved, the method still gives information which was not previously known and could contribute with important information for the engineering geological prognosis. In combination with other investigations, e.g. geophysical logging or ground based magnetic surveys, the ambiguity and uncertainty might be further reduced.

5.7 Summary and discussion

The results from the five studies at different scales elaborate the benefit of using geoelectrical methods in combination with other geophysical methods in pre-investigation for tunnel construction in hard rock. In table 5.3 the most important results from the five papers are summarised. The purposes, and thus the key-questions, are important to keep in mind when evaluating the results from the different studies. The geoelectrical method contributes with valuable information about changes in rock quality, i.e. fractures, weathering and lithology changes. In combination with other methods and by calibration with data measured in a smaller scale an engineering geological prognosis with a greater reliability can be compiled. The study also showed that data measured in the pre-investigation can be used later on in the construction work and give useful information as the work progresses.

The work with the geoelectrical method used at the Hallandsås Tunnel will form a basis for the VOIA developed in chapter 6. In the VOIA the probability that the geoelectrical and magnetic methods detect weak rock has to be estimated and for this the experience from the measurements is used. For this the comparison between geoelectrical imaging and tunnel documentation is an important part but also the more general impression of what the method is capable of in a hard rock environment is essential. The VOIA can be used to better plan future pre-investigations.

Table 5.3. Summary of the most important results from paper 1–5.

Paper	Scale	Purpose	Results
1	10–100 m	Compilation of detailed and more reliable geological model answering some of the key questions	Geoelec: fractured rock, IP/magnetic: dolerite, Geophysical logging: support the interpretation in part where resolution is poor.
2	<10 m	Development of prototype for geoelectrical measurements in horizontal boreholes	Geoelec: lithology change.
3	<1 m	Detailed information for increased reliability of geological model and calibration of surface geophysics	Geophysical logging: lithology change, fractures, weathering, good alternative to boreholes. Data for correlation and verification of surface data.
4	mm	Explanation for ambiguous resistivity of amphibolites	Microscopy: alteration of minerals, initial weathering.
5	10–50 m	Comparison of geoelectrical imaging data and tunnel documentation in an ongoing construction project. Lessons to be learned and brought forward in the project	Geoelec: changes in resistivity ~ changes in rock quality. Low res ~ several contacts, low RQD, fractures. High res ~ good quality gneiss. Int. res ~ amphibolite with fair quality (RQD = 25–75).

6 Framework for the application of Value of Information Analysis

Developing a tunnel project involves many unknown factors and uncertainties which implies a considerable risk. But decisions have to be made through the whole project and thus risk management and decision analysis become important tools. In risk management and decision analysis the probable risks which can be encountered in a project are identified and a strategy for how to handle the risks is established. Several researchers have worked with decision making and tunnel construction e.g. Degn Eskesen et al. (2004), Einstein et al. (1978), Einstein (1996), Haas and Einstein (2002), Karam et al. (2007a), Karam et al. (2007b), Min et al. (2008) and Van Staveren (2006). In Sweden important research has also been done within the area e.g. Rosén (1995), Sturk (1996), Sturk et al. (1996) and Tengborg (1998).

Even though innumerable examples can be given on how geoelectrical imaging has been useful in pre-investigation it is not an obvious choice for decision-makers, because it might still be unclear how to use the results. The results of the geophysical measurements usually have to be processed and evaluated by a geophysicist and only the geophysicist knows the sensitivity and resolution of the methods. Thus the engineer does not always have appropriate expectations of the advantages and limitations of the geophysical methods. On the other hand the geophysicist does not always have detailed understanding of what the engineer requires; e.g. at what scale information is needed. One task for the engineer and the geophysicist is to find a common language (Danielsen, 2007). Value of information analysis (VOIA) might be an approach for communicating with the decision-makers.

VOIA is an aid in decision-making in complex problems. It can help to create a rational design strategy for investigation programmes. The method is based on Bayesian statistics and cost-benefit analysis and is suitable for problems where different alternatives are evaluated and compared, e.g. the design of an investigation programme when the number of measurements or investigations needs to be determined. In VOIA the cost for new information is compared with the reduced risk for taking an economically unfavourable decision. The cost and the time it takes to obtain better information must be compared to what can be saved by modifying the investigation programme. New information is only interesting when it can change the outcome of the decision and thus is of value for the decision-maker. The cost of an investigation or measurement should be less than the expected savings; otherwise the investigation should not be made (Back, 2006; Bedford and Cooke, 2001; Freeze et al., 1992). Here VOIA is used for choosing the pre-investigation program best suited for the geological environment.

In the petroleum industry the VOIA approach has been used for evaluating if seismic and controlled-source electromagnetic data can reduce some of the uncertainty in the reservoir properties (Buland et al., 2010; Eidsvik et al., 2008). However to our knowledge the VOIA approach has never been applied to geophysical methods used in pre-investigations for rock tunnel construction. One of the central tasks is to evaluate how good geophysical methods are at detecting problematic rock conditions in otherwise good rock. Because, such an estimation can be biased (based on experience, affiliation etc.), the approach is to ask geophysical experts to judge this in order to get a more objective result. The experts use a number of simulations of possible rock volumes as a basis for estimating the probability. The expert's opinion is then, together with data from evaluation of real

geophysical investigations, the foundation for the probability used in the VOIA. The example is hypothetical but is inspired by the construction of the Hallberg tunnel in Sweden.

6.1 Theory

There are two predominant ways of conceiving probability. The traditionalists (also called frequentists) consider probability as a frequency with which things occur in a long series of trials, e.g. rolling a dice. The Bayesians on the other hand consider probability as a degree of belief and therefore admit probability statements on states of nature. In this way states of nature are considered as variables, and not unknown constants. This is consistent with engineering geology which is heavily depending on observations and uncertainty of the observations. The expert might have discretely sampled data (measurements) of how the state of nature is. Based on this the engineering geologist is expected to make a statement about the state of nature without actually having solid proofs. The engineering geologist makes an estimation of how the geological conditions are and what events are probable (Baecher and Christian, 2003).

Tunnel construction is decision making under risk where pre-investigation should reduce the risk of something unexpected happening. If the unexpected happens it will in most cases cost more time and money than a thorough pre-investigation. However a thorough pre-investigation is no guarantee that no problems will arise, because there is a probability that problematic zones are missed or underestimated. Nevertheless is an optimised pre-investigation necessary for making the best decisions with the information available in order to reduce the risk for unexpected geological problems. In VOIA the data worth is assessed by comparing the cost of data collection with the expected value of the risk reduction the data provides. The data worth assessment lead to a strategy for a rational design of a field investigation program. Such a strategy must address the questions 1) what to measure, 2) how many methods to use, succession of the methods and how many profiles, and 3) where to make the measurements (Freeze et al., 1992; Norberg and Rosén, 2006).

Additional information should always aim at reducing uncertainties and the decision to make measurements or change the design of the pre-investigation program is based on cost-effectiveness. A pre-investigation program is regarded as cost effective as long as the expected benefit associated with the new information is larger than the measurement costs. Another way of expressing this is that measurements are only justified if the sampling has potential to change decisions (Andersson et al., 2004). An insufficient pre-investigation will make it difficult to distinguish between *nothing found* because there was nothing there or *nothing found* because of deficiencies in the site-investigation (Back, 2007).

In a VOIA different action alternatives are considered and an objective function ϕ_j is applied for each alternative j (Back, 2007):

$$\phi_j = B_j - C_j - P(F)_j \cdot C_{Fj} \quad (\text{Eq. 6.1})$$

where B_j is the benefit and C_j is the investment cost. The last term is the risk term, where $P(F)_j$ is the probability of failure and C_{Fj} is the cost of failure. Failure could also be seen as an event or that something unexpected occurs. In this particular VOIA, failure in the prior analysis is when the rock is weak.

By collecting more information (more measurements/drillings), the value of the risk term is reduced and therefore the expected value of the objective function increases. The decrease in the risk term is proportional to the probability of failure. The expected increase in the objective function, ϕ_i , is the value of the pre-investigation (Back, 2007).

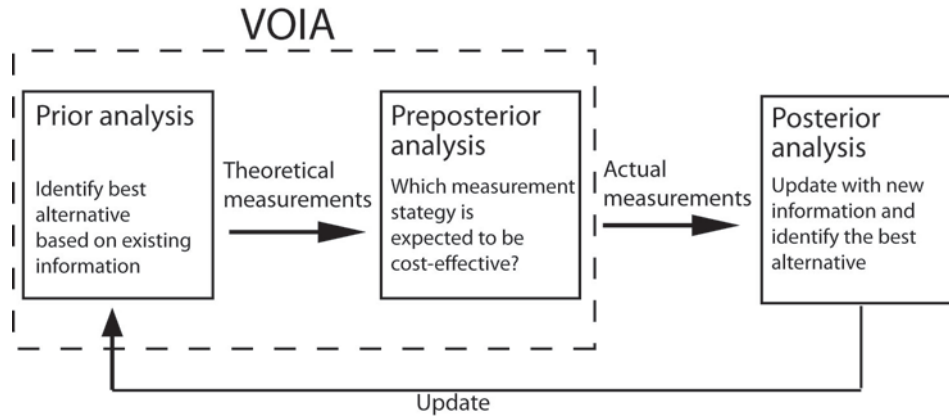

Figure 6.1. The central parts of the VOIA (modified from Back, 2006).

The VOIA consists of a *prior analysis* and a *preposterior analysis*, see figure 6.1. A part of the preposterior analysis is to calculate the *value of new information*. The VOIA only covers the planning of the pre-investigation and no calculation of the posterior value with actual data is performed. However the VOIA can be updated if another round of measurement is considered and in that case any new information should be considered when the probabilities are estimated.

The *prior analysis* is solely based on the knowledge available before any pre-investigation is carried out. It results in an expected total cost or benefit. The Bayesian inference allows the use of prior knowledge, which is very important when there is little data. Prior knowledge might come from old data (e.g. from before pre-investigation), or from some form of expert judgement (Bedford and Cooke, 2001).

The prior value of the best decision alternative is calculated as the prior objective, ϕ_{prior} (Back, 2006; Back, 2007):

$$\phi_{prior} = \max (0, P(F) \cdot C_F - C) \quad (\text{Eq. 6.2})$$

where $P(F)$ is the probability for failure (weak rock), C_F is the cost if failure occur and C is the cost for preventing failure. The cost if failure occurs is in this case the additional cost if the project is unprepared for weak rock and it entails a delay.

The probability $P(F)$ that an event F happens is said to be the marginal probability or the prior probability. An event can happen, F , or not happen F' . Two events might be related somehow, and the joint probability are said to be *conditional*. Thus given that an event happens, it can either be detected, $P(D|F)$, or not detected, $P(D'|F)$. Given that an event does not happen, it can either be detected, $P(D|F)'$, or not detected, $P(D'|F)'$. This is illustrated by the event tree in figure 6.2. (Baecher and Christian, 2003; Davis, 2002). The $P(D'|F)$ and $P(D|F)'$ are the reliability of the different alternatives and describes the accuracy of the investigation.

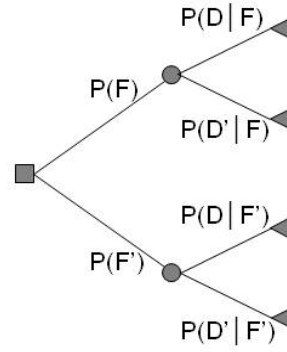

Figure 6.2. Event tree of the preposterior analysis. The square is a decision node, circles are chance nodes and triangles are terminal nodes, indicating the outcomes (modified from Back (2006)).

The *preposterior analysis* is done after the pre-investigation program is defined, but before the actual measurements are carried out (Back, 2006; Back, 2007). The preposterior analysis is also calculated using equation 6.1 but is based on the expected information from the pre-investigations. This results in an objective function, $\phi_{prepost}$:

$$\phi_{prepost} = \max(0, P(F|D') \cdot C_F - C) \cdot P(D') + \max(0, P(F|D) \cdot C_F - C) \cdot P(D) \quad (\text{Eq. 6.3})$$

The investigations have no value if both parts of the sum are negative. In order to calculate the conditional probabilities $P(F|D')$ and $P(F|D)$ Bayes' theorem is used. It relates the conditional and prior probabilities of event F and D :

$$P(F|D) = \frac{P(D|F)P(F)}{P(D|F)P(F) + P(D|F')P(F')} \quad (\text{Eq. 6.4})$$

and from the law of probability (Back, 2007; Bedford and Cooke, 2001; Olofsson, 2005; Sturk, 1998):

$$P(D) = P(F)P(D|F) + P(F')P(D|F') \quad (\text{Eq. 6.5})$$

The value of the new information (or *Expected Value of Information (EVI)*) is calculated as (Back, 2006):

$$EVI = \phi_{prepost} - \phi_{prior} \quad (\text{Eq. 6.6})$$

The EVI is always nonnegative and a value of information is only obtained if the pre-investigation has the potential to change the decision. The expected preposterior value is equal to or larger than the prior value because we make better-informed decisions (Eidsvik et al., 2008).

It is possible to estimate the value of a perfect sampling program, thus there are no errors in the measurements, without performing a preposterior analysis. This is the *expected value of perfect information (EVPI)* and represents an upper limit on EVI and the maximum exploration budget that can be justified without performing a preposterior analysis (Back, 2007).

The EVI does not consider the cost, C_{preinv} , of the pre-investigation program. If the cost of the investigations should be considered the *Expected Net Value (ENV)* is calculated:

$$ENV = EVI - C_{preinv} \quad (\text{Eq. 6.7})$$

A *posterior analysis* should be performed after the actual pre-investigation has taken place. In this analysis the real worth of the obtained information is calculated and a new updated VOIA is performed using the posterior as prior information (Bedford and Cooke, 2001).

The idea of updating a prior distribution to obtain a posterior distribution gives an important role to the expert. The expert has to decide on the form of the prior distribution. This combination of giving weight to experts but still allowing for scientific evidence makes Bayesian reliability very useful in geo-science (Bedford and Cooke, 2001).

6.2 Tunnel project

The tunnel project used in this example is hypothetical but derived from a real tunnel case in the central part of Sweden; an 800 metre long railway tunnel called Hallberg tunnel. In the central parts of this tunnel the maximum overburden is 25 to 30 metres. The tunnel is constructed using drill and blast with a tunnel face of $6 \times 6 \text{ m}^2$. The geological setting in the area is dominated by greywacke and granite. There are elongated sections with pegmatite and dolerite dykes. The valleys that are found on both sides of the tunnel coincide with regional fracture zones that vary between 10 and 20 metres wide. The soil deposits are relatively thin and in some areas the bedrock is exposed or covered by a thin layer of lichen and moss. The terrain is dominated by forested till and marsh.

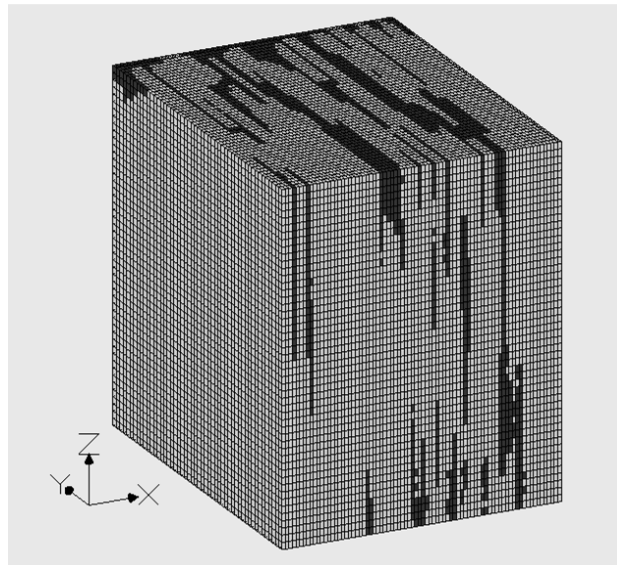

Figure 6.3. An example of a 3D simulation. Modified from Zetterlund (2009)

For this hypothetical example a simple geological model was generated in the statistical software T-PROGS (part of the computer program GMS from Aquaveo). The simulations are kindly made available by Miriam Zetterlund (Zetterlund, 2009). For more details about the simulations see paper 6 and Zetterlund (2009). The realization of the possible rock volume (example shown in figure 6.3):

- Each cell is $1 \times 2 \times 2$ metre (i.e. $80 \times 100 \times 100$ metre)
- The virtual tunnel will be constructed in the central cells (3×3 cells)
- Two rock classes, good rock (RC1) and poor rock (RC2)

- Problematic rock are fracture zones and clay weathered rock (poor rock)
- Good rock is unaltered
- 10 % poor rock (black)

6.3 Estimation of probabilities

It is difficult to obtain an un-biased estimation of the value of geophysics because the concept of the methods can vary from expert to expert and accordingly geophysics is not easily amenable to mathematical representation. Nevertheless the probability that geophysics detects weak rock is essential to this VOIA. The study of the applicability of the geoelectrical method (Chap. 5) is a natural and important base for the author to estimate these probabilities. In an attempt to make the used probability more reliable seven experts were asked their opinion of how good a geophysical method is in the geological environment of the hypothetical example. The experts have all worked with the application of geophysical methods in hard rock environment in national and/or international tunnel projects. How the answers from the experts were used is described in more details in paper 6.

As part of the evaluation of the geophysical methods, the experience from geophysics in other tunnel projects is used, so that not only the experts opinions are considered for estimating the probability. The experience from Hallandsås Tunnel (Chap. 5 and Danielsen and Dahlin, 2009) and Bolmen Tunnel (Stanfors, 1987) both in southern Sweden, are used together with work done by NGU in Norway (Rønning, 2003). The geological settings in the examples are different but still it is possible to obtain an impression of the probability of finding a weak zone using the different geophysical methods.

6.4 Framework

In the following a framework is presented where the value of geophysical measurement in pre-investigation for rock tunnel construction is evaluated. The geophysical methods are geoelectrical imaging and ground based magnetic measurements. The suggested pre-investigation program is discussed further in paper 6. In this framework a responsible authority (e.g. Trafikverket) plans to build a tunnel and orders a pre-investigation from a consultant (Fig. 6.4). The first step for the consultant is to produce an early (rough) engineering geological prognosis (based on archive data and field visits). The consultant has to decide what the major concerns are and how to proceed with the pre-investigations. Should a detailed prognosis be done or is the early prognosis enough as basis for contract negotiation? If a detailed prognosis is made, should it then consist only of drillings or also geophysics? These question marks are answered by VOIA. When the basis for contract negotiation is ready the contractors can start giving offers on the work.

In the VOIA there are different decision alternatives (Fig. 6.5). In the prior analysis it has to be decided which of the construction alternatives to use. The first alternative is to assume that 10% of the rock is poor (reference alternative). This means that when constructing the tunnel reinforcement class BFK3b is used in 10% of the tunnel length. For a description of the reinforcement classes see appendix B in paper 6. In alternative two it is assumed that 40% of the rock is poor and requires reinforcement with BFK3b. Thus the construction is more expensive. In the preposterior analysis it has to be decided which of the pre-investigation programs to use: 1) two core drillings or 2) geoelectrical imaging, ground based magnetic (in the following called geophysics) and two core drillings positioned based on the geophysics.

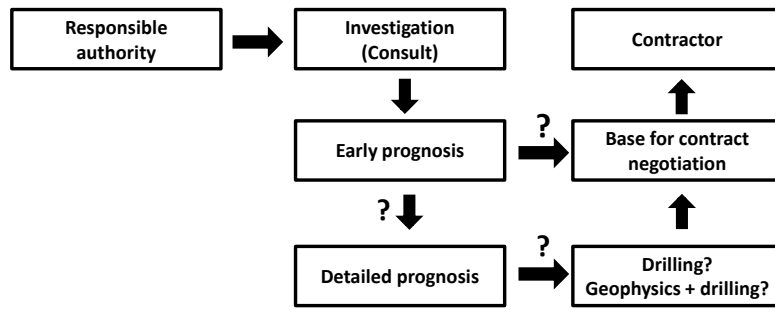

Figure 6.4. The flow in the decision process for a construction work. The question marks are answered by VOIA.

The probabilities necessary for the cost-benefit analysis are based on 10 simulations (different from those evaluated by the seven experts). It is decided that failure in the prior analysis is when the rock is weak (RC2).

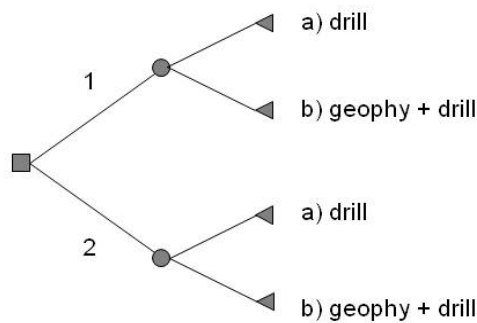

Figure 6.5. Decision tree for the problem in this VOIA. Squares are decision nodes, circles are chance nodes and triangles are terminal nodes. First decision (prior analysis) is regarding construction alternatives: 1 is standard and 2 is extensive. Second decision (preposterior analysis) is regarding pre-investigation alternatives: a) drillings or b) geophysics combined with drillings.

6.4.1 Prior analysis

In the prior analysis it has to be decided which construction alternative to use, standard or extensive. In the standard approach the cost for the construction is lower than in the more extensive approach. The input data and results are given in table 6.1 and 6.2 and the calculations in the prior analysis are shown in appendix B in paper 6. The probability of failure is calculated using the simulations as described in paper 6 (step 2). It turned out that $P(F)$ is 0.5 and thus $P(F')$ is also 0.5. This is so even if there in the T-PROGS simulation only is 10% RC2. However it has to be acknowledged that the sections are regarded as poor if more than 1 pixel in each section is RC2. It is assumed that in the construction of the tunnel it is not possible to switch reinforcement class for each metre, so there has to be a *reaction length*, which is said to be a full section.

If the unexpected occurs the construction cost might increase because of the increased amount of materials needed (e.g. shotcrete + bolts) but more importantly due to the increase in construction time. In Malmtoorp and Lundman (2010) and Kim and Bruland (2009) it is estimated that it takes 50% longer time to construct a tunnel if e.g. BFK3 is used instead of BFK1. Therefore it is assumed here that the cost is 50% higher when the change from one strategy to another is unexpected. This additional cost if the unexpected happens (C_F , failure) is calculated for each alternative. The probability, $P(F)$, that something unexpected happens was 0.5 and when the strategy is to only use the extensive reinforcement in 10 out of 100 sections the project is unprepared in 40 out of 100

sections. In alternative 2 the project is only unprepared in 10 out of 100 sections. The difference between the cost of failure in the two alternatives is called the switchover cost, C_{switch} , and is the cost for the additional time needed because the project is unprepared for the required reinforcement. The failure cost is lowest in alternative 2 and thus the $C_{\text{switch}} = C_{F1} - C_{F2} = 13770$ kSEK. 1 kSEK is 105 euro (September 2010).

Table 6.1. The input data for the prior analysis.

Cost	kSEK	
Cost of tunnel (alternative 1)	C_1	10085
Cost of tunnel (alternative 2)	C_2	14389
Difference	$C_i = C_2 - C_1$	4304
Probability		
Probability for RC2	$P(F)$	0.5
Probability for RC1	$P(F')$	0.5

Table 6.2. The calculated output data from the prior analysis.

Alternative 1		kSEK
Cost of tunnel	C_1	0
Cost of failure	C_{F1}	110160
Risk cost	R_1	6885
Benefit	B_1	0
Alternative 2		
Cost of tunnel	$C_i = C_2 - C_1$	4304
Cost of failure	C_{F2}	96390
Risk cost	R_2	1721
Benefit	B_2	5164
Objective functions		
C_{switch}	$C_{F1} - C_{F2}$	13770
Value of alternative 1	$\phi_{1\text{prior}}$	0
Value of alternative 2	$\phi_{2\text{prior}}$	860
Value of prior analysis	ϕ_{prior}	860

The risk in alternative 1 is that the construction strategy has to be changed if something unexpected happens. The risk is calculated as: $R_1 = P(F) C_{\text{switch}}$. For alternative 2 the risk is $R_2 = R_1/4$, because the project only is unprepared in 10/100 sections and not 40/100 sections.

In the first alternative with the standard approach the benefit is zero whereas the benefit of using the extensive and more expensive approach is a lower risk for something unexpected to happen: $B_2 = R_1 - R_2$. In other words the benefit is what is saved if the project is prepared for change in reinforcement strategies. In the prior analysis the prior objective function is calculated for both alternatives using equation 6.2, i.e. $\phi_i = B_i - C_i$, and is the expected net benefit with present information. The best alternative is the one with the highest value for the project. The value of the prior analysis is calculated as $\phi_{\text{prior}} = \max(\phi_{1\text{prior}}, \phi_{2\text{prior}}) = \max(0, 860 \text{ kSEK}) = 860 \text{ kSEK}$. Therefore the alternative 2 with the extensive construction approach is the best decision.

6.4.2 Preposterior analysis

In the preposterior analysis the value of a pre-investigation is calculated before the measurements are done and is therefore the expected net benefit with information from the planned sampling program. It has to be decided if the best alternative is to only do core drillings or if the best alternative is to do geophysics prior to core drillings. The probability for detecting failure using geophysics or no geophysics is estimated as described in paper 6 (step 3). The input data for the preposterior analysis are given in table 6.3 and the calculations can be seen in appendix B, paper 6.

Table 6.3. The input data for the preposterior analysis.

		Only boreholes	Geophysics and boreholes	EVPI
Probability for RC2	P(F)	0.50	0.50	0.50
Probability to detect RC2	P(D F)	0.40	0.68	1
Probability to detect RC2 that not exist	P(D F')	0.27	0.03	0

Table 6.4. The results from the preposterior analysis.

		Only boreholes	Geophysics and boreholes	EVPI
Conditional probability	P(F D)	0.60	0.95	1
Conditional probability	P(F D')	0.45	0.25	0
Probability of detection	P(D)	0.33	0.35	0.50
		kSEK	kSEK	kSEK
Preposterior value	ϕ_{prepost}	2581	3123	4733
Expected value	EVI	1721	2253	3873
Exp. Net value	ENV	1441	1863	

The preposterior value, ϕ_{prepost} for both alternatives is calculated using equation 6.3:

$$\phi_{\text{prepost}} = \max(0, C_{\text{switch}}P(F | D') - C_i)P(D') + \max(0, C_{\text{switch}}P(F | D) - C_i)P(D)$$

The conditional probabilities used in the preposterior analysis is calculated using Bayes' theorem (Eq. 6.4) and P(D) from the law of probability (Eq. 6.5). The results are summarised in table 6.4.

The preposterior value, ϕ_{prepost} of only drilling boreholes in the pre-investigation is 2581 kSEK, whereas the value of a combination of geophysics and a borehole is 3123 kSEK. And therefore geophysics combined with a borehole is the best alternative. In the calculation of the preposterior value in appendix A it is seen that the value of not achieving data (D') is zero whereas the value of achieving the data (D) is 8777 kSEK.

6.4.3 Value of perfect information

Calculating the EVPI means that the probabilities $P(D' | F)$ and $P(D | F')$ both are zero and perfect information is obtained. The EVI for the perfect information (EVPI) is 3873 kSEK. This is regardless of which alternative is chosen for the pre-investigations.

6.4.4 Expected value and expected net value

The expected value EVI, that is the value of new information, is calculated $EVI = \phi_{\text{prepost}} - \phi_{\text{prior}}$ (Eq. 6.6). For the project the information has a value or worth even though there is a cost combined with the decision. For using geophysics the EVI is 2253 kSEK. The EVI for only drilling boreholes is 1721 kSEK and therefore this alternative has a lower value for the project. If the cost for the pre-investigation should be considered the expected net value for geophysics, ENV is calculated to 1863 kSEK using equation 6.7. However the pre-investigation program should in the best case also contain geophysical borehole logging and pumping tests. But in the ENV only the methods considered here are used in the calculations.

6.5 Sensitivity analysis

An essential part of this VOIA is the sensitivity analysis of the different input variables. For the analysis of the different variable's uncertainty a Monte Carlo simulation is made where a large number of random solutions ("qualified guesses") are calculated. In this case 10^5 simulations were done. The parameters are systematically altered to determine the effects of such changes. In this way the robustness of the study is investigated. Monte Carlo uses statistical distributions to represent different kinds of uncertainty and for the analysis a probability density function (pdf) has to be chosen for each of the stochastic variables (Burgman, 2005). This is a difficult part and in this case a beta-distribution is applied. For the pdf's the mean and standard variation is calculated.

In this analysis the only cost-variables to consider is the cost of failure, C_{F1} and C_{F2} . The other costs in the calculations depend on these two variables and therefore it is not reasonable to analyse any other. It is assumed that the two costs are normal distributed and that they to some extent are dependent on each other and therefore the correlation is said to be 0.6. The probabilities $P(F)$, $P(D | F)$ and $P(D | F')$ are said to be beta-distributed in all alternatives. The input data for the simulations and the probabilities are seen in table 6 and 7 in paper 6.

Table 6.5. The results from the simulations of the preposterior analysis.

		Only boreholes	Geophysics and boreholes	EVPI
Expected value > 0	EVI > 0	~100%	100%	~100%
		kSEK	kSEK	kSEK
Mean value (given that EVI > 0)		1683	2218	3826
Standard deviation		351	312	301
Exp. Net value	ENV	1403	1828	

In 13.4% of the 10^5 simulations the construction alternative 1 was the best solution in the prior analysis. In the remaining 86.6% of the simulations the alternative 2 was the best solution. For the preposterior analysis the results of the simulations can be seen in table 6.5. The mean value of only drillings is 1683 kSEK and the standard deviation is 351 kSEK. For the combination of geophysics and drillings the mean value is 2218 kSEK and standard deviation is 312. In only 13 of the 96634 simulations (with $EVI > 0$) the solution with only drillings is the best alternative.

6.6 Discussion

In the prior analysis conducted in this example it was seen that the extensive construction approach is the best alternative. The value of the standard approach is zero and the value of the extensive is 860 kSEK and therefore the latter is the best alternative because the prior function (Eq. 6.2) is maximised. The sensitivity analysis showed that the standard approach is the best solution in 13.4% of the 10^5 simulations. It is notable that the best alternative is to assume that it is necessary to use BFK3 instead of BFK1 in 40% of the tunnel, even though in this simulation only 10% of the rock is classed as poor rock (RC2). The reason is probably that it is assumed that in the construction of the tunnel it is not possible to switch reinforcement class for each metre and therefore a larger ratio of the volume is regarded as RC2.

The preposterior analysis showed that the highest value is obtained by using a combination of ground based magnetic measurements, geoelectrical imaging and core drillings as base for compiling an engineering geological prognosis. The expected value of new information (EVI) is approximately 2250 kSEK which should be seen in relation to a total construction cost of 104800 kSEK. The expected value of using the information from only core drillings is approximately 1700 kSEK. However there are uncertainties in the calculations from both the probabilities and the cost. In an attempt to reduce the uncertainty seven experts were asked their opinions. Nevertheless an un-biased estimation of the value of geophysics is still difficult to obtain because the confidence in the methods can vary from expert to expert. The answers from the experts are further discussed in paper 6. A combination of the experts opinions and the experience from the use of the geoelectrical method in chapter 5 and other tunnel projects is a good foundation for estimating the probabilities for this specific project. However the probabilities used in the example are calculated based on 10 simulations, which means they are rather uncertain in statistical terms. A sensitivity analysis is therefore conducted to support the results. Even though the framework originates from a real tunnel case it has been a challenge to estimate the cost if failure occurs (switchover cost) because such a cost is first negotiated if delay occurs and/or increased material expenses exceeds the budget. Consequently the question is very complex and beyond the scope of this framework. The main focus is the value of pre-investigation and not contractual problems. Here a switchover factor based on literature examples (Malmtorp and Lundman, 2010); Kim and Bruland, 2009) is estimated and used in the calculations.

The sensitivity analysis showed that in nearly 100% of the simulations it would have a value to perform only core drillings. However the analysis also showed that the alternative with only drillings had the highest ENV in only 13 of the 96634 simulations where ENV was positive. Otherwise alternative 2 including geophysics have the highest ENV. The chance/risk that the highest data value is obtained with performing only drillings is therefore minimal. However it should be taken into consideration that the drillings in this case only has the purpose to detect RC1 or RC2 based on what is seen at the surface. The drilling gives point information and might miss a weak zone nearby. In reality a core drilling is also used for e.g. laboratory tests, and therefore has a value for a project in that sense, but this value is not taken into account in the analysis. Nevertheless the difference in EVI between the two decision alternatives is relatively large and therefore implies that it can be strongly recommended for the decision-makers to perform a profound pre-investigation including geophysics (in this case ground based magnetic measurements and geoelectrical imaging) as guideline for where to do the drillings.

The value of perfect information (EVPI) is 3873 kSEK and can be considered as the maximum cost for the investigations to be worthwhile to perform. However perfect information is hypothetical and in a construction project it is impossible to obtain so much information that the risk for something unexpected to happen is zero. The sensitivity analysis of the EVPI (for $EVI > 0$) gives a mean value of 3826 kSEK with a standard deviation on 301 kSEK. Thus it can be concluded that not even geophysics and boreholes gives perfect information. As for the alternative with only boreholes the geophysical data can also have additional value in a later project phase that not is considered here.

The geological model and the problems considered in this VOIA are a simplification of reality. The model can be further developed and become more complex. However this VOIA is meant as a demonstration of the general idea behind VOIA and the considerations behind the framework are generally valid when geophysics is evaluated.

The aim with this VOIA was to show that it is important to use a suitable geophysical method prior to drilling; however there will always remain some uncertainties in the engineering geological prognosis no matter how many measurements are made. But with the VOIA the value of new information from ground based magnetic measurements and geoelectrical imaging is assessed by estimating the reliability in the present information compared to the expected increase in reliability following collection of new information. New information is only interesting when it can change the outcome of the decision and thus is of value for the decision-maker. The benefit of having the most certain engineering geological prognosis is less risk and a more predictable cost. The benefit should be seen as the amount of money saved when the best decision is made. The cost of an investigation or measurement should be less than what is expected to be saved; otherwise the investigation should not be made (Back, 2006; Bedford and Cooke, 2001; Freeze et al., 1992). Applying these lines of thought to geophysics gives the decision-maker the opportunity to evaluate the reliability in an approach without actually being an expert in either VOIA or geophysics. A cost-benefit analysis shows in clear terms if it is worthwhile to incur the cost of additional measurements or not. VOIA is a model of reality and is therefore also encumbered with uncertainty, but a sensitivity analysis gives a clear idea of the reliability.

VOIA is an aid for decision-makers to evaluate the value of different alternatives before taking action and is therefore in this case an attempt to show the value of geophysics by using an approach the decision-makers understand. The framework developed here has the potential to become an integral part of pre-investigation. The analysis should be done after the archive study and prior to the first geophysical measurements. In many construction projects some kind of geophysical method is used e.g. refraction seismic, but this is not always the case. In some projects it might be very beneficial to use another or additional geophysical method, e.g. geoelectrical imaging, seismic, magnetic or a combination. VOIA can help evaluate and design the best measurement program for a specific geological setting. An important issue with a VOIA is that it is constructed specifically for every problem and cannot be re-used from project to project. The cost-benefit calculations are relatively simple to perform and with the framework developed it is straightforward to change the costs and probabilities in the calculations.

7 Discussion

Different geophysical methods are important parts of a profound pre-investigation and as shown in chapter 2.1 and 5 the use of for example the geoelectrical method at different scales contributes to the understanding of the geological setting. In the following the possibilities, strengths and weaknesses of the geoelectrical method as well as the application of value of information analysis (VOIA) are discussed.

7.1 Evaluation of Geoelectrical methods

It is important that the expectations as to what the geoelectrical method can accomplish are realistic for successful use of this method. Geoelectrical imaging is relatively unknown in Sweden whereas e.g. refraction seismic has been a natural part of pre-investigation for decades, so people have experience with how to use the seismic data with respect to advantages and limitations. The examples in chapter 5 show how the geoelectrical method can be applied in rock tunnel construction where not only the advantages but also the limitations are addressed. This will hopefully contribute to realistic expectations to what can be accomplished using the geoelectrical method.

A successful outcome of the use of the geoelectrical method depends on the physical properties in the investigated area. Before the method is used it has to be investigated if the approach is suitable in the specific geological setting. The method has its strength in areas where the resistivity contrast between the poor and good rock is sufficiently large, e.g. weathered zones or water bearing fractures in crystalline rock. It is the transition between the different rock properties that are important to detect because problems during construction arise if the poor rock is not anticipated. The size of the zones that can be detected depends very much on the resistivity contrast but also on the target depth and scale of the measurements.

An important task is to interpret the data and translate the resistivity data to a property useful to the decision makers. The resistivity is ambiguous, and thus for interpretation a general knowledge of the geological setting and reference data is needed. However the need for reference data for calibration of the geological model based on the geoelectrical imaging should not be seen as a limitation of the method. Reference data can be found in the initial archive study, but the optimal is drilling data and borehole geophysics which can be considered ground truth at a single point. An integrated part of the pre-investigation is core drilling, thus reference data exist or will be procured in most cases. Boreholes provide point information that can be used for in situ correlation with the geoelectrical imaging (CVES) data. The CVES provides a continuous 2D (or 3D) model of the subsurface in a profile line between the drilled boreholes. The cores from the drillings can also be used for laboratory tests. With continuous data supplied by the CVES the uncertainty of the ground conditions is greatly reduced.

The geoelectrical method can be used at different scales and at different stages of a project. The geoelectrical imaging is used at large scale in the design/production planning stage (Chap. 2.1 and paper 1) and in the construction stage (paper 5). Electrical Resistivity Tomography (ERT) is measurements between boreholes and is therefore performed at a smaller scale mainly in the construction stage (paper 2). For even more details the resistivity logs can be part of a borehole

geophysical campaign (paper 3 and 4). Borehole geophysics is normally applied late in the design/production planning stage.

In the design/production planning stage the geoelectrical imaging (CVES) is the basis for a geological model. The method detects variations in the physical properties of the rock and in a combination of several geophysical methods that measure different physical properties, a realistic view of the rock mass can be obtained. By using CVES in the pre-investigation in the Pungwe water tunnel the intended tunnel line was moved to an area with better rock quality. Thereby problems with weathered rock were avoided in an area with high environmental demands. The combination of CVES (resistivity and IP) and ground based magnetic data has proven to be useful in the geological environment at the Hallandsås Horst. Prior to drillings an evaluation of the geophysical data should be done so the drillings can be positioned to ensure that as much representative information as possible is obtained for calibration of the geological model. In the construction stage the geoelectrical imaging data can be calibrated with the tunnel documentation to update the geological model and thereby reduce the uncertainty in the model. Continuous update of the model is especially important if the Observational Method is used (e.g. Peck, 1969; Terzaghi and Peck, 1948).

What is important to anticipate when using geoelectrical imaging is that the target area, i.e. the depth of the tunnel, should be within the depth where the method has acceptable resolution. The resolution decreases with depth. The penetration depth depends on different factors, e.g. resistivity, array type and largest electrode distance. Generally a penetration depth of 60 metre is achieved with a standard 400 metre cable layout. This entails two persons in the field. If the penetration depth should be larger (~120 metre) a cable layout of 800 metre is necessary. As an example this was done at the Hallandsås Horst when the data in figure 2.2 was measured. Alternatively, the more demanding pole-dipole measurement can be used, as was the case for the data in figure 5.2. For the longer cable layout, the pole-dipole measurement is more time consuming in the field due to the requirement for a remote electrode and will therefore be more expensive.

The continuous CVES data in 2D, or even 3D, are measured in a relatively fast and cost efficient way compared to refraction seismic. The geoelectrical imaging should not blindly be used instead of refraction seismic but should be seen as an alternative in the geological environments where the geoelectrical method has its strengths. At the Hallandsås Horst geoelectrical imaging, correlated with e.g. drillings and geophysical logging, indicates fractured, water bearing rock, weathered rock and to some extent lithology changes in the crystalline bedrock. In this particular geological environment with the tunnel occasionally drilled 150 metre beneath the surface, the scale of resolution of the resistivity method is tens of metres at tunnel level. Thus in this case the method cannot resolve bodies or structures smaller than this.

The ERT can contribute to the understanding of the ground condition both in the design/production planning stage and in the construction stage. However measurements done in horizontal boreholes, as described in paper 2, are mainly justified in the construction stage in front of a TBM. If the geology varies on a small scale, the boreholes drilled in front of the TBM might not be representative of the rock mass between the boreholes. The initial attempts to use the approach as described in paper 2 give promising results. However, the measuring routines have to be optimized to be used in an actual construction stage.

As part of borehole geophysics, the resistivity logs give detailed information in a design/production planning stage. Unfortunately only a few sets of geophysical logging equipment exists in Sweden and therefore borehole geophysics is normally not an integrated part of pre-investigations and is often disregarded due to the additional cost. However percussion drilling, including geophysical logging with the probes used in chapter 5.4, is approximately one third of the cost of core drilling. The strength of borehole geophysics is the high resolution and the detailed in-situ data. Additionally continuous data are obtained even in weak rock where there might not be full core recovery. Furthermore data are saved for later re-interpretation of the ground conditions as they were when the data was recorded. The logging data is very valuable for calibration of the surface geophysical data. With this calibration the uncertainty of the geological model is reduced. However when surface based data are calibrated with logging data it is important to acknowledge the difference in scale. The surface based CVES data are measured over a large rock volume where small scale variations are seen as average values, whereas the logging data can resolve every small variation.

The fewer question marks there are in an engineering geological prognosis the higher the chance that problematic ground conditions will be predicted. Ground conditions can be very complex and different factors contribute to the physical properties of a rock so that it is sometimes necessary to go into very great detail for an explanation. Even though geophysical logging gives great details there might still be some ambiguity in the interpretation of the results. To answer some of the questions it can become necessary to go into even greater details. The example in chapter 5.5 (paper 4) shows clearly that what seems to be some artefact actually has a physical explanation. It stresses that the geophysical data are right, but that the interpretation might be difficult to make because the geology is complex. Microscopy of thin sections can help answering some of the questions that might be raised during interpretation of geophysical data. However there is often neither time nor money to seek an explanation for a problem like this because it has limited importance for the tunnel construction. However the practical importance is not always possible to predict and who knows which detail is of great significance to a project? The initial weathering of the amphibolite may turn out to have real significance for the rock mechanical properties and this would not have been detected without geophysical logging and microscopy of the thin sections.

Numerical modelling is valuable for obtaining experience and learning more about the advantages and limitations of the geoelectrical method in a specific geological environment. In the conference proceeding Danielsen and Dahlin (2008) and in paper 2 numerical modelling is used to clarify some questions in the interpretation of data.

7.2 Value of Information Analysis

The VOIA framework developed in chapter 6 shows that geoelectrical imaging and ground based magnetic measurements as a basis for positioning core drillings give valuable information that can reduce the uncertainty and thereby the risk in the current tunnel project. The example used is a relatively simple case with an 800-metre long tunnel constructed using drill and blast. Even with a fairly moderate budget and time schedule it is still worthwhile to perform the more profound pre-investigation. With a 50% higher cost of a strategy change due to unexpected geological conditions, the extra cost for the geophysics will in most cases be worthwhile. For a major tunnel project with more complex geological settings the costs if something unexpected happens might even be much

higher. A worst case scenario could be if the work has to be stopped or an incorrect construction approach is used. This would naturally make the cost of failure even higher than the 50% assumed in the example.

Several examples of the successful use of geophysical methods in pre-investigations are given in chapter 5 and by others (e.g. Cavinato et al., 2006; Dahlin et al., 1999; Danielsen and Dahlin, 2009; Ganerød et al., 2006; Rønning, 2003; Stanfors, 1987), but presenting the methods in a VOIA emphasizes the importance in terms decision-makers are familiar with. The VOIA is a simple cost-benefit calculation where the value of different alternatives is evaluated before taking action. Applying VOIA to geophysics gives the decision-maker the opportunity to evaluate the uncertainty in an approach without actually being an expert in either VOIA or geophysics. A cost-benefit analysis shows if it is worthwhile to take the cost for additional measurements or not. VOIA is a model of reality and is therefore also encumbered with uncertainty; however a sensitivity analysis gives a clear idea about the uncertainty of the different variables.

The VOIA framework developed here has the potential to become an integrated part of pre-investigation. The analysis should be done after the archive study and prior to the first geophysical measurements so that VOIA can help evaluate and design the best measurement program for a specific geological setting. An important issue with VOIA is that it is constructed specifically for every problem and cannot be re-used from project to project. The cost-benefit calculations are relatively simple to perform and with the framework developed it is straightforward to change the costs and probabilities in the calculations.

7.3 Essentials for successful pre-investigation

This work on the applicability of geoelectrical methods in pre-investigations has led to some more general reflections on what is essential for a successful pre-investigation and construction project. In the following sections several important issues are discussed.

7.3.1 Geological setting (complexity, hazards)

The complexity and the expected hazards in the geological environment are decisive for the form of the pre-investigation. The more complex a geological setting is the more extensive the investigation program has to be. Thus it is immediately after the archive study that the pre-investigation program should be decided. The VOIA of pre-investigation methods presented in this thesis would be a natural aid for this decision. Additionally a program should be dynamic and flexible so that it is possible to do more or fewer investigations. This may be a problem because there is normally no budget for doing more investigations in most projects. However it has to be stressed that having the flexibility to extend the investigation program might in the end save large sums of. By applying VOIA in the planning of a pre-investigation the program can be optimised and the money can be used in the best way.

A significant area of concern is where the scope of the pre-investigation is determined by the project owner with a limited budget and little or no understanding of the engineering geological requirements of the project (Baynes, 2003). Often a way of saving money is to e.g. cut down additional measurements or borehole measurements. The chain of reasoning is often that enough information is obtained and that there is neither time nor money for more investigations. But what is

enough? What has to be taken into account is that the certainty of the prognosis will increase considerably by doing an optimised pre-investigation program. Malmtorp and Lundman (2010) have shown that the uncertainty of the pre-investigation is important for the outcome of the project. An uncertain pre-investigation result is a contributory reason for delays and increased budgets. However a thorough and optimised pre-investigation is no guarantee that no problems will arise, because there is a risk that problematic zones are missed or underestimated. Nevertheless an optimised pre-investigation is necessary for making the best decisions with the information available in order to reduce the risk.

7.3.2 Existing information in a national geo-database

Prior knowledge of an area is essential for a pre-investigation. The more existing information there is the easier it will be to plan the best possible investigation program and to estimate the costs for the program. But often it is difficult to get hold of the existing material because it is archived at the consultants who carried out the previous investigations. Thus if an individual at the consultant company who did the survey changes job, it can become difficult to locate the data and reports. It would be beneficial if a national database is established in Sweden so that all types of geo-data can be saved and made available. It should be a natural part of a project to report the raw data and interpreted models to this database. The idea is that whenever a new project is planned it should be possible for the involved parties to extract information from the national geo-database. In this way all data are preserved for future projects. During the last decades Denmark has developed a high quality database, initiated as part of the national groundwater mapping (Møller et al., 2008). This database facilitates the interpretation and analysis of data covering large areas and allows for visualization of the data. The different tools in the system connect to and interact with each other in a transparent and intelligent manner. Work must be carried out directly on a copy of the database, and all relevant information on each data point and model must be accessible for use any time during the analysis and interpretation procedure.

7.3.3 Central project database to handle geo-data

A central project database makes it possible to access and manage the geo-data at all times. This makes it easier to update the engineering geological prognosis. The database should contain both raw data and interpreted models. Having both types of data in the database makes it possible without difficulty to make a reinterpretation of the raw data if e.g. additional data is gathered or better interpretation tools evolve. The obtained information becomes more transparent and thus better decisions can be taken on engineering issues. If it should come to a dispute within the project, then the documentation is still easily accessed. Additionally the project would not be so sensitive towards changing personnel. The central database should also become part of the national geo-database so that the data can be preserved for the future and easily be accessed and used in other projects.

Documentation from the tunnel projects should also be a natural part of the database (see chapter 5.1). By integrating the tunnel documentation the engineering geological prognosis can be updated and the tunnel construction can be done more safely with less uncertainty. This is especially an advantage when the Observational Method is applied (Peck, 1969; Terzaghi and Peck, 1948). The Observational Method is applicable when the uncertainties in the pre-investigations are high. The method is often used when it is possible to alter the design of the construction.

7.3.4 Consistency in pre-investigation report

If a project is large with several tunnels, e.g. Ådalsbanan or Botniabanan in Sweden, the pre-investigation report from the single tunnels should be compiled in the same way. It is advisable that the flow of the investigation (top-down) is maintained through all reports. It is often seen that different consultant companies investigate the different tunnels. To avoid any misunderstandings and make it easier for e.g. the contractor to locate the information, the project owner should put up guidelines for the report form. The succession should be top down giving the large scale information first ending up with small scale information.

7.3.5 Communication

Above all else good communication is fundamental to a project's successful outcome. This requires engineering geologists/geologists/geophysicists who are aware of the engineering issues and rock mechanics engineers and construction engineers who can appreciate the value of geological advice. The project manager, the technical specialist, and the geophysicist form an interdisciplinary team to meet the objectives. Therefore it is important that the involved parties are capable of communicating sensibly and are able to express clearly their requirements and expectations from the pre-investigations. The consultant is responsible for understanding the overall needs of a project owner/contractor and effectively communicating the relevant geologic findings and ideas. Here the central project database becomes essential in that it allows all the involved parties to easily access the data.

7.3.6 Integration of knowledge

Often it is not the methods used that are the problem but rather how the results are presented and integrated. From the first attempt (1992-1995) at the Hallandsås Tunnel (Chap. 2.2) it can be learned that it does not matter how many different geophysical methods are used if the information is not considered in the decision making process. Therefore the knowledge obtained has to be promoted into the project and integrated into the decisions, as has been the case in the Hallandsås project from 2003 onwards.

The knowledge that experienced staff possesses has to be integrated and acknowledged in the decision process. However the term "*we always do like that*" has to be avoided since it might not be the best solution in all cases. It is important to be open minded through the whole project and make the best and optimal decisions with the information available. Here it is especially important that the best suited geophysical method is used in the current geological setting. There is a tendency to use the geophysical method and the instrument which is available at the time. However in some cases it might be an advantage to think differently and use another method. This might be more expensive if the instruments has to be hired along with a field crew and experienced personnel for processing the data. Nevertheless the obtained knowledge might be so important for the outcome of the project that the extra cost is acceptable.

7.3.7 Realistic expectations

It is important to acknowledge, when interpreting geophysical data that the measurements are done in order to answer specific questions and that each project is unique. This means that considerations have to be made before the data is used for other purposes. The data might contain more information, especially if calibrated with other types of data, but it is important to know the limitations of e.g. resolution of the method.

The construction phase of the Pungwe water tunnel in Zimbabwe is a good example (chapter 2.1) of how data measured for another purpose is over-interpreted. An attempt was made to determine the depth to the crystalline basement by means of the resistivity data. However what was interpreted as the surface of the crystalline basement turned out to be large boulders succeeded by soil at the proposed water intake (Uden, 2010). Since the resistivity contrast between dry soil and crystalline bedrock is small, defining the transition would be a difficult task. In such a geological setting it is crucial that borehole information is available for calibration of the model. This stresses the importance of having the right expectations and knowing the advantages and limitations of the methods in very specific geological environments before interpretation of the data. Otherwise there is a tendency to focus on the examples where the methods did not live up to the expectations as opposed to examples where the method was successful.

7.3.8 Experience/skills

A project owner has to be skilled and experienced enough in order to avoid unnecessary risks, ask the right questions and demand that the best possible pre-investigation is done. Often an external consultant is hired to perform the pre-investigations. A limitation could be that the consultant does not know the overall needs for a project owner/contractor to make the best decisions. A pitfall is the tendency for the consultant (i.e. geophysicist/geologist) to focus on what can be measured, and not on the needs of the contractor/project owner.

Generally it can be said that the measured geophysical data are correct; however the interpretation of the model might be wrong. To avoid this it is advisable to engage experienced and skilled geophysicists for the interpretation of the models based on the geophysical data and supported by other type of geo-data. Only few consultancy companies in Sweden have experienced geophysicists to process and interpret data and to handle a fully integrated pre-investigation for large infrastructure projects. In addition the field crew performing the measurements has to be skilled and very meticulous to avoid that e.g. data are measured at an inexact position or with unfavourable instrument settings. Another important issue is how the data, results and models are presented regarding scale, colours and succession. For laymen these parameters can be very deceptive and easily lead to an incorrect interpretation.

The foundation for skilled personnel is a good education. A tendency is unfortunately that the students at universities have very little or no experience with hands on pre-investigation techniques. Field trips are relatively expensive and are therefore under prioritized. It is always easier to comprehend the advantages and limitations of the many different methods by hands on experience. Furthermore in-service courses that present the latest developments and the state of the art for pre-investigations should be accorded a high priority for all parties involved in construction work in rock. The development within the topic is fast due to faster computers and the demand for higher data quality. Universities and research organisations have an especially large responsibility to ensure that the latest developments are disseminated within the construction community.

7.3.9 The importance of the contract form

For the involved parties the importance and meaning of the pre-investigation depends very much on the contract form and who carries the risk and responsibility. The form of the contract can vary where the responsibility more or less rest with the project owner or contractor. It is important to predict and anticipate possible risks before writing the contract and should also include actions to be

taken if deviations occur during construction, not least deviations from original geological assumptions (Tengborg, 1998).

The project owner does always have responsibility for characterization of the ground conditions, i.e. they have the responsibility for planning and completion of the pre-investigation. This means that if the ground conditions are different than anticipated a dispute can arise between the project owner and the contractor. Thus it should be in the project owner's interest that the pre-investigation is as good as possible and with low uncertainty. However the project owner has to avoid increased budgets and often do not have any incentive to spend under budget. The consultant's objective is to make the project owner satisfied and do a good job economically. Thus for the consultant it is important to establish a good relationship with the project owner, to be considered serious and to maintain a good reputation. As a consequence the consultant is often not interested in taking risks and will choose solutions *on the safe side* that will not necessarily lead to the lowest cost (Tengborg, 1998). The problem with the *safe side* approach is also discussed by Malmtorp and Lundman (2010) where an over pessimistic approach may be taken in the estimation of the rock quality. Here the rock quality is estimated to be weaker than is the actual case, and this makes it difficult to calculate the correct price and the project might become more expensive than necessary. This can lead to a negative attitude towards pre-investigation because the impression is that the investigation is wrong and a consequence is that a certain method might be disregarded in the next project.

By dividing the risk all involved parties becomes interested in a good pre-investigation because the financial profit becomes larger. The consequences of delays are too large for all the involved parties. It is an advantage for the outcome of the project if there is an inducement or bonus for all parties if the project goals are attained either, below budget or ahead of schedule. An inducement for a thorough pre-investigation could be in the form of a financial bonus if the project is ahead of schedule.

8 Conclusions

In this thesis the main focus has been on the applicability of the geoelectrical method as a tool for predicting geological and rock mass conditions. Applying the geoelectrical method at different scales has proven to provide useful information at different stages of rock tunnel construction. The large scale geoelectrical imaging is useful in the design/production planning stage and in the construction stage. Electrical Resistivity Tomography (ERT) is performed in a smaller scale in mainly the construction stage. At even smaller scale the geoelectrical method can be combined with other geophysical methods in borehole logging and applied late in the design/production planning stage.

Before the geoelectrical method is used it is important to ask what can be expected when applied in a specific bedrock environment with regards to rock mass variations. Here the engineer's key questions are important in order to identify plausible problems. To answer such questions is complex, because the resolution of the method will differ from site to site. The method responds to changes in resistivity and the range of the variations to be detected; the resistivity contrast and size of the different zones have to be sufficiently large for the method to resolve. When interpreting geoelectrical data it is important to keep in mind that the resolution of the method decreases with depth. The penetration depth of the method depends on several factors, e.g. maximum electrode separation, array types and resistivity of the bedrock. In general the target depth should not be more than half of the penetration depth in order to obtain a reasonable resolution. Nevertheless it is feasible for the target depth to be larger, but this has to be acknowledged in the interpretation of the result.

The use of geoelectrical imaging at the Hallandsås Horst demonstrates that the method can indicate fractured, water bearing rock, weathered rock and to some extent lithology changes in crystalline bedrock. In this particular geological environment with the tunnel drilled 150 metre beneath the surface, the scale of resolution of the resistivity method is tens of metres at tunnel level. Thus in this case the method cannot resolve bodies or structures smaller than this.

The advantage with geoelectrical imaging is that it gives continuous data in 2D or 3D whereas drilling provides only point information. When considering using geoelectrical imaging it is vital that reference data, such as borehole geophysics and drill cores, exist for calibration and interpretation of the data. However reference data is also needed for the interpretation of any other geophysical data. Geoelectrical imaging is generally cheaper than seismic refraction. However the two methods should not be compared because they respond to completely different physical properties and should rather be used in combination instead of at the expense of each other.

The numerical modelling and the application of geoelectrical imaging in horizontal boreholes gave promising results. An important outcome of the study was that the prototype of the semi-rigid cable proved to work well. Further adjustments of the acquisition hardware and software have to be done before geoelectrical measurements in probe holes can be implemented at a production stage in tunnel construction.

Borehole geophysics (incl. resistivity logs) supply valuable small scale information late in the pre-investigation. The advantage with borehole geophysics is that they provide high resolution in-situ data. These data are useful for calibration of the large-scale measurements and are especially

important because they give information about weak rock at localities where there might not be full core recovery. In addition the data are recorded and can be re-interpreted at a later date if that becomes necessary. The combination of borehole geophysics in percussion drilled boreholes is a cheaper alternative to core drilling, especially if a core drilled hole exists for calibration.

By going into even smaller details with microscopy of thin section an explanation was found to an ambiguous resistivity of amphibolites in two boreholes. Initial stage of weathering explains the lower resistivity of an amphibolite which otherwise seems un-weathered. This proves that the measured geoelectrical data are correct but the interpretation might be difficult and therefore it can help to investigate even greater details.

The framework for a VOIA of geophysical methods used in pre-investigation showed that the value of performing geoelectrical imaging and ground based magnetic measurements prior to positioning drillings has a higher value than to perform drillings only. This result is only valid for this particular geological setting and is site specific. Nevertheless the framework is applicable to all projects where geophysics used in pre-investigation should be evaluated. It can help in designing the best measurement program for a specific geological setting if the VOIA is to decide between different geophysical methods, e.g. geoelectrical imaging, seismic, magnetic or a combination. The framework developed here has the potential to become an integrated part of a pre-investigation. The analysis should be done after the archive study and prior to the first geophysical measurements.

Several factors are important for a successful pre-investigation and tunnel construction. The pre-investigation should be performed top down so that the investigations start at large scale and continue into more and more details which follows the need for information in the different project stages. The focus should all the time be on the key questions necessary for making the best decisions through the project. The pre-investigation should be a dynamic process where the prognosis is updated when new information is available. The report presenting the results from the investigations should be structured in a consistent way following the top down approach. The examples from the Pungwe water tunnel, Zimbabwe, and Citytunneln, Sweden, show that geoelectrical imaging and a profound pre-investigation is of great value for a project. In order to stress the importance of integration of information obtained throughout the project life, the substantial pre-investigations from the Hallandsås Tunnel and the Citytunneln, Sweden, are compiled. Communication within a project and thereby also the integration of the knowledge is essential for the outcome of the project. It does not matter how many methods are used if the results are disregarded. A project database with all geo-data helps the integration of information and keeps a dynamic flow in the project.

With a profound and optimised pre-investigation and well-integrated results, the reliability of the engineering geological prognosis is higher and the risk that something unexpected happens is thereby reduced. Geoelectrical imaging and borehole geophysics contribute to reduce the uncertainties and should therefore be considered as a prospective part of all pre-investigations as well as of the production stage.

9 Recommendations

The VOIA presented in this thesis has the potential to become an integrated part of a pre-investigation. However it needs to be further developed and tested using other geological models and geophysical methods.

During my work with the applicability of geoelectrical methods and borehole geophysics for rock tunnel construction I have realized that for the methods to be fully accepted it has to become clear what advantages and limitations the method has. The aim with my work is to show how to use the methods, and it is also important to acknowledge that the methods should only be used when it has the potential to answer questions and thereby reducing the uncertainty. If the methods are used in unfavorable geological settings it will not supply the necessary information and as a consequence it will get a bad reputation. Therefore it is important that the advantages and limitations are clear. The best way for this to become clear is education. It is crucial that students at the universities are educated in pre-investigation methods and that they get the opportunity to try the different methods in the field. It is also important that the different parties involved in pre-investigations have the possibility to follow progress and developments within the area by attending workshops and courses. I highly recommend that more focus is put on education of all the parties involved in pre-investigation.

Only a few sets of borehole geophysical logging equipment exist in Sweden but I sincerely hope that the results of the borehole geophysics presented in this thesis support the increased use of this method. The approach has a high potential and I can only recommend that it is used more often.

During my work I have become aware of that the information in the pre-investigation reports often is given in the following succession: field visit, core drillings and geophysics (often refraction seismic, if anything at all). This is an illogical succession, and violates the suggested pre-investigation progression shown in figure 3.2. Instead the large-scale information should be gathered prior to the small-scale information. This makes it easier for the reader of the reports, i.e. project owner and contractor, to find and evaluate the information they need at the right time.

Additionally a national geo-database should be developed. Such a database would be beneficial to all pre-investigation thus it would make it possible to get access to geo-data from past projects. As the situation now stands valuable information is lost because it is up to each consultant and projects to archive the data in any format they choose. The database could be maintained by the Geological Survey of Sweden (SGU) and be financed by the users. The Swedish society would also benefit of such a database and could therefore contribute to financing the development and construction of the database.

10 References

- Almén, K.-E., Olsson, P., Rhen, I., Stanfors, R., and Wikberg, P., 1994, *Äspö Hard Rock Laboratory - Feasibility and usefulness of site investigation methods. Experiences from the pre-investigation phase*. In SKB (Swedish Nuclear Fuel and Waste Management Company), ed., Stockholm, Technical Report 94-24.
- Andersson, J., Munier, R., Ström, A., Söderbäck, B., Almén, K.-E., and Olsson, L., 2004, *When is there sufficient information from the Site Investigations?* In SKB (Swedish Nuclear Fuel and Waste Management Company), ed., Stockholm, R-04-23.
- Back, P.E., 2006, *Value of information analysis for site investigations in remediation projects*. [Ph.D. Thesis]: Department of Civil and Environmental Engineering, Division of GeoEngineering, Chalmers University of Technology, Göteborg, Sweden.
- Back, P.E., 2007, A model for estimating the value of sampling programs and the optimal number of samples for contaminated soil. *Environmental Geology*, v. 52, p. 573-585.
- Backblom, G. and Stanfors, R., 1986, The Bolmen tunnel-tunnelling through the staverhult fault zone. *Engineering Geology*, v. 23, p. 45-57.
- Baecher, G.B. and Christian, J.T., 2003, *Reliability and statistics in geotechnical engineering*. John Wiley & Sons Ltd.
- Banverket, 1996, *Handling 11.5 Primärdata bergundersökningar Hallandsåsen. Bilaga D Geohydrologiska undersökningar inkl. underbilagor D1-D7.*, Banverket, Södra Banregionen. (In Swedish)
- Banverket, 2002, *Handling 8.3 Geologisk-hydrogeologisk prognos.*, Banverket, Södra Banregionen. (In Swedish)
- Baynes, F.J., 2003, Generic responsibilities of engineering geologists in general practice. *Conference proceeding. New Zealand Geotech. Soc. Symp. IPENZ Proc. Tech Groups*.
- Baynes, F.J., Fookes, P.G., and Kennedy, J.F., 2005, The total engineering geology approach applied to railways in the Pilbara, Western Australia. *Bulletin of Engineering Geology and the Environment*, v. 64, p. 67-94.
- Bedford, T. and Cooke, R., 2001, *Probabilistic Risk Analysis: Foundations and methods*. Cambridge University Press.
- Bergman, S.G.-A. and Carlsson, A., 1988, *Site Investigations in Rock. Investigations, prognoses, reports- recommendations*. In BeFo (Swedish Rock Engineering Research Foundation), ed., Stockholm, BeFo 86:2/88.
- Binley, A. and Kemna, A., 2005, *DC resistivity and induced polarization methods*. In Rubin, Y. and Hubbard, S., eds., Hydrogeophysics. Springer, p. 129-156.
- Bjelm, L., 2010, Personal Communication, Engineering Geology, Lund University, Sweden.

- Buland, A., Løseth, L.O., and Røsten, T., 2010, The Value of CSEM Data in Exploration, *Conference proceeding. 72nd EAGE Conference & Exhibition incorporation SPE EUROPEC 2010, Barcelona, Spain*.
- Burgman, M., 2005, *Risks and decisions for conservation and environmental management*. Cambridge University Press.
- Butler, D.K., 2005, *Near-Surface Geophysics*: Society of Exploration Geophysicists.
- Butler, J.J., 1990, The Role of Pumping Tests in Site Characterization: Some Theoretical Considerations. *Ground Water*, v. 28, p. 394-402.
- Carmichael, R.S., 1989, *Practical Handbook of physical properties of rocks and minerals*. CRC Press, Inc. Boca Raton, Florida.
- Cavinato, G.P., Di Luzio, E., Moscatelli, M., Vallone, R., Averardi, M., Valente, A., and Papale, S., 2006, The new Col di Tenda tunnel between Italy and France: Integrated geological investigations and geophysical prospections for preliminary studies on the Italian side. *Engineering Geology*, v. 88, p. 90-109.
- Citytunnelprojektet, 2003, Citytunneln, www.citytunneln.com.
- Dahlin, T., 1996, 2D resistivity surveying for environmental and engineering applications. *First Break*, v. 14, p. 275-283.
- Dahlin, T., 1998, *Resistivity surveying at Pungwe, Zimbabwe*, in unpublished report for Skanska.
- Dahlin, T., Bjelm, L., and Svensson, C., 1999, Use of electrical imaging in site investigations for a railway tunnel through the Hallandsås Horst, Sweden. *Quarterly Journal of Engineering Geology*, v. 32, p. 163-172.
- Daily, W. and Owen, E., 1991, Cross-borehole resistivity tomography. *Geophysics*, v. 56, p. 1228-1235.
- Daily, W., Ramirez, A., LaBrecque, D., and Barber, W., 1995, Electrical resistance tomography experiments at the Oregon Graduate Institute. *Journal of Applied Geophysics*, v. 33, p. 227-237.
- Daniels, J.J. and Keys, W.S., 1990, *Geophysical Well Logging For Evaluating Hazardous Waste Sites*. In Ward, S.H., ed., *Geotechnical and Environmental Geophysics, Vol 1, Review and Tutorial*. Society of Exploration Geophysicists, p. 263-285.
- Danielsen, B.E., 2007, *The applicability of geoelectrical imaging as a tool for construction in rock*. [Licentiate Thesis]. Engineering Geology. Lund University, Lund, Sweden.
- Danielsen, B.E. and Dahlin, T., 2008, Numerical modelling for improvement of the interpretation of geoelectrical and induced polarization measurements, *Conference proceeding. 14th European Meeting of Environmental and Engineering Geophysics, Krakow, Poland*.
- Danielsen, B.E. and Dahlin, T., 2009, Comparison of geoelectrical imaging and tunnel documentation at the Hallandsås Tunnel, Sweden. *Engineering Geology*, v. 107, p. 118-129.
- Danielsen, B.E. and Dahlin, T., 2010, Numerical modelling of resolution and sensitivity of ERT in horizontal boreholes. *Journal of Applied Geophysics*, v. 70, p. 245-254.

-
- Danielsen, B.E. and Madsen, H.B., 2010, Difference in resistivity explained by initial stage of weathering. *Conference proceeding. 16th Meeting Environmental and Engineering Geophysics, Zurich, Switzerland.*
- Davis, J.C., 2002, *Statistics and data analysis in geology.* John Wiley & Sons, Inc.
- Deceuster, J., Delgranche, J., and Kaufmann, O., 2006, 2D cross-borehole resistivity tomographies below foundations as a tool to design proper remedial actions in covered karst. *Journal of Applied Geophysics*, v. 60, p. 68-86.
- Degn Eskesen, S., Tengborg, P., Kampmann, J., and Holst Veicherts, T., 2004, Guidelines for tunnelling risk management: International Tunnelling Association, Working Group No. 2. *Tunnelling and Underground Space Technology*, v. 19, p. 217-237.
- Denis, A., Marache, A., Obellianne, T., and Breyse, D., 2002, Electrical resistivity borehole measurements: application to an urban tunnel site. *Journal of Applied Geophysics*, v. 50, p. 319-331.
- Eidsvik, J., Bhattacharjya, D., and Mukerji, T., 2008, Value of information of seismic amplitude and CSEM resistivity. *Geophysics*, v. 73, p. R59-R69.
- Einstein, H.H., 1996, Risk and Risk Analysis in Rock Engineering. *Tunnelling and Underground Space Technology*, v. 11, p. 141-155.
- Einstein, H.H., Labreche, D.A., Markow, M.J., and Baecher, G.B., 1978, Decision analysis applied to rock tunnel exploration. *Engineering Geology*, v. 12, p. 143-161.
- Ellis, D.V. and Singer, J.M., 2007, *Well Logging for Earth Scientists.* Springer.
- Ernstson, K., 2006, *Magnetic, geothermal, and radioactivity methods.* In Kirsch, R., ed., *Groundwater Geophysics - A tool for hydrogeology.* Springer, p. 275-320.
- Fetter, C.W., 2001, *Applied hydrogeology.* Prentice Hall, New Jersey.
- Freeze, R.A., James, B., Massmann, J., Sperling, T., and Smith, L., 1992, Hydrogeological Decision Analysis: 4. The Concept of Data Worth and Its Use in the Development of Site Investigation Strategies. *Ground Water*, v. 30, p. 574-588.
- French, H.K., Hardbattle, C., Binley, A., Winship, P., and Jakobsen, L., 2002, Monitoring snowmelt induced unsaturated flow and transport using electrical resistivity tomography. *Journal of Hydrology*, v. 267, p. 273-284.
- Ganerød, G.V., Rønning, J.S., Dalsegg, E., Elvebakk, H., Holmøy, K., Nilsen, B., and Braathen, A., 2006, Comparison of geophysical methods for sub-surface mapping of faults and fracture zones in a section of the Viggja road tunnel, Norway. *Bulletin of Engineering Geology and the Environment*, v. 65, p. 231-243.
- Goes, B.J.M. and Meekes, J.A.C., 2004, An Effective Electrode Configuration for the Detection of DNAPLs with Electrical Resistivity Tomography. *Journal of Environmental & Engineering Geophysics*, v. 9, p. 127-142.
- Graversen, O., 2009, Structural analysis of superposed fault systems of the Bornholm horst block, Tornquist Zone, Denmark. *Bulletin of the Geological Society of Denmark*, v. 57, p. 25-49.

- Guérin, R., 2005, Borehole and surface-based hydrogeophysics. *Hydrogeology Journal*, v. 13, p. 251-262.
- Gustafson, G., 2009, *Hydrogeologi för bergbyggare*. Forskningsrådet Formas. (In Swedish).
- Haas, C. and Einstein, H.H., 2002, Updating the Decision Aids for Tunneling. *Journal of Construction Engineering and Management*, v. 128, p. 40-48.
- Henriksson, J., 1996, Pungwe - Mutare Water Supply Project, Zimbabwe, in Course material, ed., www.lwr.kth.se.
- Howard, K.W.F., 1990, *Geophysical Well Logging Methods for the Detection and Characterization of Fractures in Hard Rock*, in Ward, S.H., ed., *Geotechnical and Environmental Geophysics*, Vol. 1, Review and Tutorial. Society of Exploration Geophysicists, p. 287-307.
- ISRM, 1981, Suggested methods for geophysical logging of boreholes. *International Journal of Rock Mechanics and Mining Sciences and Geomechanics Abstracts*, v. 18, p. 67-84.
- Karam, K.S., Karam, J.S., and Einstein, H.H., 2007a, Decision Analysis Applied to Tunnel Exploration Planning. I: Principles and Case Study. *Journal of Construction Engineering & Management*, v. 133, p. 344-354.
- Karam, K.S., Karam, J.S., and Einstein, H.H., 2007b, Decision Analysis Applied to Tunnel Exploration Planning. II: Consideration of Uncertainty. *Journal of Construction Engineering & Management*, v. 133, p. 354-364.
- Kim, Y. and Bruland, A., 2009, Effect of rock mass quality on construction time in a road tunnel. *Tunnelling and Underground Space Technology*, v. 24, p. 584-591.
- Kirkpatrick, I.M., 1973, *Preliminary geological report on a proposed diversion tunnel, Pungwe River, Inyanga District*, Geological Survey Office, Salisbury, Zimbabwe, p. 1-8.
- LaBrecque, D.J., Ramirez, A.L., Daily, W.D., Binley, A.M., and Schima, S.A., 1996, ERT monitoring of environmental remediation processes. *Measurement Science and Technology*, v. 7, p. 375-383.
- Lantmäteriverket, 2001, GSD - Terrängkartan (Map):513.
- Liboriussen, J., Ashton, P., and Tygesen, T., 1987, The tectonic evolution of the Fennoscandian Border Zone in Denmark. *Tectonophysics*, v. 137, p. 21-29.
- Loke, M.H., 2004, RES2DINV ver. 3.54, M.H.Loke on www.geoelectrical.com.
- Malmtorp, J. and Lundman, P., 2010, *Förundersökningar vid undermarksprojekt - Osäkerheter och deras hantering*, Trafikverket, p. 3-82. (In Swedish).
- mappery.com, 2010, Fullsize Zimbabwe, www.mappery.com.
- Min, S.Y., Kim, T.K., Lee, J.S., and Einstein, H.H., 2008, Design and construction of a road tunnel in Korea including application of the Decision Aids for Tunneling - A case study. *Tunnelling and Underground Space Technology*, v. 23, p. 91-102.

-
- Møller, I., Jørgensen, F., Søndergaard, V.H., and Auken, E., 2008, Integrated planning of hydrogeophysical data on a national scale: From processing, interpretation and storage to visualisation. *Conference proceeding. International Geological Congress Oslo 2008, August 6 - 14th, Norway*.
- Ngan-Tillard, D., Venmans, A., and Slob, E., 2010, Total engineering geology approach applied to motorway construction and widening in the Netherlands. *Engineering Geology*, v. 114, p. 164-170.
- Nielson, D.L., Linpei, C., and Ward, S.H., 1990, *Gamma-Ray Spectrometry and Radon Emanometry in Environmental Geophysics*. In Ward, S.H., ed., *Geotechnical and environmental geophysics*, vol 1: Review and tutorial. Tulsa, Society of Exploration Geophysicists, p. 219-250.
- Norberg, T. and Rosén, L., 2006, Calculating the optimal number of contaminant samples by means of data worth analysis. *Environmetrics*, v. 17, p. 705-719.
- Olofsson, P., 2005, *Probability, statistics, and stochastic processes*. John Wiley & Sons, Inc.
- Paillet, F.L. and Ellefsen, K.J., 2005, *Downhole Application of Geophysics*. In Butler, D.K., ed., *Near-Surface Geophysics*, p. 439-471.
- Palacky, G.J., 1987, *Resistivity Characteristics of Geologic Targets*. In Nabighian, M.N., ed., *Electromagnetic methods in applied geophysics*. Society of exploration geophysics, p. 56-130.
- Parasnis, D.S., 1986, *Principles of Applied Geophysics*. Chapman and Hall.
- Peck, R.B., 1969, Advantages and limitations of the Observational Method in applied soil mechanics. *Géotechnique*, v. 19, p. 171-197.
- Rasmussen, K.R. and Bai, W., 1987, Logging in deep water wells in central Jutland, Denmark. *Boreas*, v. 16, p. 393-404.
- Reynolds, J.M., 1997, *An Introduction to Applied and Environmental Geophysics*. John Wiley & Sons.
- Rosén, L., 1995, *Estimation of Hydrogeological Properties in Vulnerability and Risk Assessment* [Ph.D. Thesis]. Dept. of Geology, Chalmers University of Technology, Göteborg, Sweden.
- Robinson, E.S. and Coruh, C., 1988, *Basic exploration geophysics*: John Wiley & Sons.
- Rønning, J.S., 2003, *Miljø- og samfunnstjenlige tunneler. Sluttrapport delprosjekt A, Forundersøkelser*, NGU, Report nr. 2003.007. (In Norwegian).
- Schepers, R., Rafat, G., Gelbke, C., and Lehmann, B., 2001, Application of borehole logging, core imaging and tomography to geotechnical exploration. *International Journal of Rock Mechanics and Mining Sciences*, v. 38, p. 867-876.
- Segesman, F.F., 1980, Well-logging method. *Geophysics*, v. 45, p. 1667-1684.
- Stanfors, R., 1987, *The Bolmen tunnel project. Evaluation of geophysical site investigation methods*, Stockholm, In SKB (Swedish Nuclear Fuel and Waste Management Company), ed., Stockholm, Technical Report 87-25.

- Stanfors, R., Triumph, C.-A., and Emmelin, A., 2001, *Geofysik för bergbyggare*. Stockholm, SveBeFo (Swedish Rock Engineering Research), p. 1-66. (In Swedish).
- Sturk, R., 1996, *Decision and risk analysis for underground projects - with emphasis on geological hazards* [Licentiate Thesis]. Division of Soil and Rock Mechanics, Department of Civil and Environmental Engineering, Royal Institute of Technology, Sweden.
- Sturk, R., 1998, *Engineering Geological Information - Its Value and Impact on Tunnelling* [Ph.D. Thesis]. Division of Soil and Rock Mechanics, Department of Civil and Environmental Engineering.
- Sturk, R., Olsson, L., and Johansson, J., 1996, Risk and Decision Analysis for Large Underground Projects, as Applied to the Stockholm Ring Road Tunnels. *Tunnelling and Underground Space Technology*, v. 11, p. 157-164.
- Swedish Geological Survey, 1981, SGU Ser. Af nr 133 Flygmagnetiska Kartan 4C Halmstad SV:Af nr 133.
- Takahashi, T., 2004, ISRM Suggested Methods for land geophysics in rock engineering. *International Journal of Rock Mechanics and Mining Sciences*, v. 41, p. 885-914.
- Takahashi, T., Takeuchi, T., and Sassa, K., 2006, ISRM Suggested Methods for borehole geophysics in rock engineering. *International Journal of Rock Mechanics & Mining Sciences*, v. 43, p. 337-369.
- Tengborg, P., 1998, *Risker vid stora undermarksprojekt - planering, produktion och förvaltning*, Stockholm, SveBeFo (Swedish Rock Engineering Research), Report nr. 38. (In Swedish).
- Terzaghi, K. and Peck, R.B., 1948, *Soil Mechanics in Engineering Practice*. New York, John Wiley & Sons.
- Trafikverket, 2010, Hallandsås, www.trafikverket.se.
- Uden, J., 2010, Personal Communication, Head of construction, Pungwe water tunnel, Zimbabwe.
- Van Staveren, M.Th., 2006, *Uncertainty and Ground Conditions: A Risk Management Approach*. Butterworth-Hinemann.
- VBB VIAK, 1999, *Banverket, Södra banregionen Skottorp-Förslöv, Ny järnväg, Tunnlar genom Hallandsås. Uppdaterad bedömning av berggrundsförhållanden. Resultat av kompletterande geoundersökningar åren 1998-99. Erfarenheter från utförd tunneldrivning*, Malmö. Sweden. Report nr. 1240149.500. (In Swedish).
- VBB-COWI Joint Venture, 2000a, *Completion of existing geological and geotechnical investigation*, Report no 2, Malmö, Sweden.
- VBB-COWI Joint Venture, 2000b, *Evaluation of existing ground water investigations*, Report no 3, Malmö, Sweden.
- VBB-COWI Joint Venture, 2000c, *Geotechnical design basis*, Report no 7, Malmö, Sweden, p. 1-122.
- Wikman, H. and Bergström, J., 1987, *Beskrivning till Berggrundskartan Halmstad SV*, Uppsala, Swedish Geological Survey.

Wisén, R. and Christiansen, A.V., 2005, Laterally and mutually constrained inversion of surface wave seismic data and resistivity data. *Journal of Environmental & Engineering Geophysics*, v. 10, p. 251-262.

Zetterlund, M., 2009, *Geological Characterisation and the Observational Method Application of Value of Information Analysis* [Licentiate Thesis]. Department of Civil and Environmental Engineering. Chalmers University of Technology, Göteborg, Sweden.

Paper 1 Danielsen, B.E., Arver, H., Karlsson, T. and Dahlin, T.
(2008)

**Geoelectrical and IP imaging used for pre-investigation at a
tunnel project.**

*Conference proceeding. 14th Meeting Environmental and Engineering Geophysics, Krakow, Poland,
15-17 September 2008, P44, 4p.*

Geoelectrical and IP imaging used for pre-investigation at a tunnel project.

B.E. Danielsen, H. Arver, T. Karlsson and T. Dahlin.

Abstract

At a large tunnel project in Southern Sweden a number of geoelectrical and IP imaging were carried out. The tunnel is drilled through a horst with a complex geology which includes fractures, high water content and weathered zones. The measurements were carried out to compile a geologic model to use in the further planning of the project. The resistivity and IP complements each other very well since they focus on different specific characteristics. IP proved to be useful at locating dolerites and resistivity was useful for the general distribution of fractures. An advantage is that with the seven-channel Lund Imaging system both types of data can be measured in a fast and cost efficient way. Magnetic measurements are a good supplement to pinpoint the exact position of the dolerite. Based on the general geologic information, resistivity and IP measurements recommendations can be given on where to drill in order to improve the geological model.

Introduction

When constructing tunnels and other large rock projects in Sweden the preferred method for the pre-investigations has traditionally been drillings. Drillings gives point information and in a complex geology this is not sufficient for a reliable engineering geological model. Therefore continuous geophysical measurements should be performed prior to drillings with the purpose to make a targeted drilling campaign and perhaps even reduce the number of drillings. Previous research carried out by Dahlin et al. (1999) showed good results from a combination of resistivity imaging, core drilling and geophysical logging used at the Hallandsås Horst, Sweden. Rønning (2003) investigated the usefulness of geophysical methods in the early stages of construction work and concludes that 2D resistivity investigations often is better and more cost efficient than traditional refraction seismic. At a tunnel project in Southern Sweden geoelectrical and induced polarization (IP) measurements has been performed together with ground based magnetic measurements. Based on this information a geological model is compiled to be used in the further planning of the tunnel construction.

Geological setting

The tunnel is made through the most northern of the Scanian horsts. Gneisses of presumably intrusive origin dominate in the area. Amphibolites of several generations occur where the oldest often is seen as minor layers or schlieren in the gneiss. The bedrock is intruded by a set of young dolerite dykes that run in the same direction as the Scanian horsts. These dolerites are steeply standing dykes which can have a width up to 50 metre (Wikman & Bergström, 1987). The dolerite dykes are seen as very distinct linear positive anomalies on the aeromagnetic map (Swedish Geological Survey, 1981). A substantial deep weathering of the bedrock began under Triassic and periodically continued under Cretaceous. This resulted in a clay-weathering to i.e. kaolin. The weathering is documented in core drillings from the area. In the core drillings it is also clear that there is often secondary mineralization such as chlorite development in the fractures (Wikman & Bergström, 1987).

The horst is an important groundwater reservoir. There are two types of reservoirs; one in the soil layer (< 20 metre thick) and one in the basement. In the bedrock the water flows in a complex web of fractures. The fractures created by the tectonic activity have made it possible for large amounts of water to be stored within the bedrock. The tunnel level is 100-150 metre below the water table resulting in high water pressures and continuous leakage during tunnel construction.

Method

The geoelectrical and IP measurements were carried out using a version of ABEM Lund Imaging System that allows measuring in 7 channels simultaneously, with Terraohm RIP924b as receiver and ABEM SAS2000 as transmitter (max 400V or 500mA, max 40W). The pole-dipole array was used because of a larger median depth of penetration. A total of 900 metres were measured using the roll along method. Each layout was 400 metres having electrode spacing of 5 and 10 metres. A special technique was used in order to reduce the noise in the IP data. The current was transmitted in one cable and the potential was measured in another. By doing this the capacitive coupling is reduced. The cables were arranged parallel with around one meter distance. The measured data was inverted in the program Res2dinv using robust inversion.

The magnetic data was measured using a GSM858 caesium-vapour magnetic gradiometer manufactured by Geometrics Inc. The sampling rate corresponds approximately to a 10 cm sampling distance. The magnetic profiles covers only 480 metres from $x = 400$ to $x = 880$. The data was processed in the MagMap2000 software from Geometrics Inc. and then plotted in Matlab. An older magnetic dataset, but from the same section, was modelled using the software GMM (Gravity and Magnetic Modelling) from GeoVista AB.

Two existing core drillings (KB5336 and KB5450) as well as geological maps were available as reference data.

Results

The resistivity, IP and magnetic measurements can be seen in figure 1. The mean residual in the inverted resistivity is 5.1 % and for the IP it is 18.5 %. The first time window (20 ms long) was used for the IP section.

The inverted resistivity section in figure 1A shows that the first 500 meters from northeast have a top layer where the resistivity is higher than 3000 Ωm . Below this the resistivity is between 1000 and 2000 Ωm . Between $x = 400$ and 450 there is a zone with resistivity higher than 300 Ωm 60 metres below the surface. In the last 400 metre of the profile the resistivity section changes character. There is no high resistive top layer. Instead there is a low resistive (200-400 Ωm) 40 metre thick layer. Below this the resistivity is between 600 and 2000 Ωm .

The inversion result of the IP data is seen in figure 1B. The profile is dominated by a 200 meter wide zone with an IP effect higher than 100 mV/V. This zone starts 10 to 20 metre below the surface. In the north eastern part of the profile there seems to be an upper layer with a thickness of 60 metre and an IP effect between 20 and 60 mV/V. Below this the IP effect is less than 10 mV/V.

The magnetic data is shown in figure 1C. A previous modelling of the same anomaly and the used parameters are seen in figure 2. The modelling result and the general knowledge about the geological setting suggest that the dyke is dolerite.

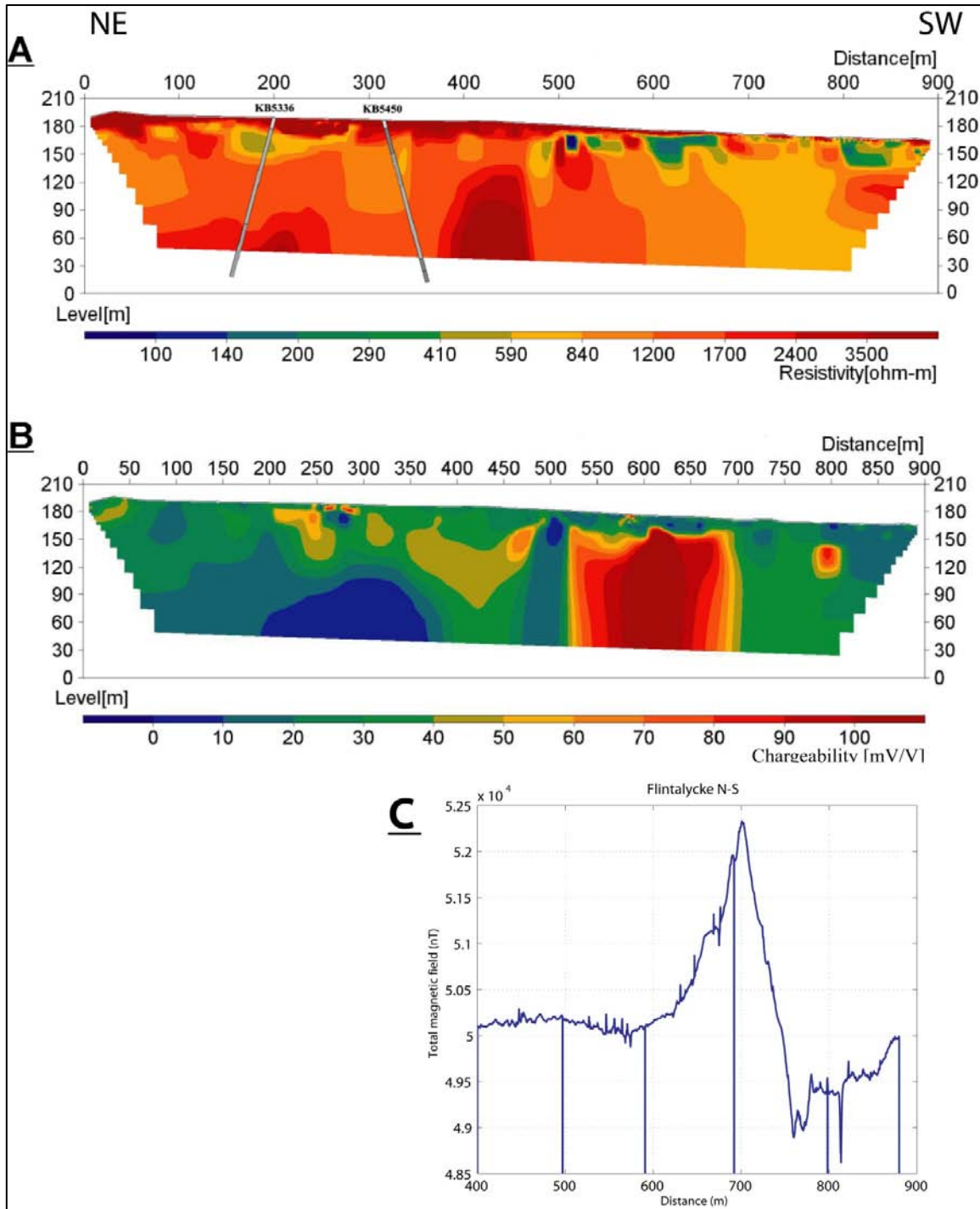
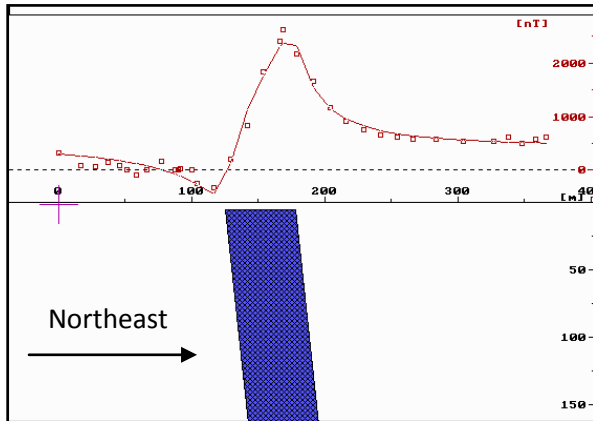

Figure 1. (A) Inverted resistivity results for the 900 metre profile. The positions of two existing core drillings are marked in the profile. In (B) the inverted IP can be seen and in (C) the result from the magnetic measurement is shown.

Discussion

For the locations with access to drilling data (table 1) it can be seen that changes in both the resistivity and the IP coincides well with the core drillings. For example between $x = 0$ and 370 metres there is low resistivity and high IP effect from 186-120 m.a.s.l. which coincides well with the fractures observed in the core drillings.



Parameters	Value
Susceptibility, dyke	0.1 [SI]
Susceptibility, surrounding	0.022 [SI]
Q-factor	1.2
Inclination of remanence	-10
Declination of remanence	220
Depth to top of body	5.6 metres
Width of the body	50 metre
Strike angle from y-axis	10.3°
Strike length	820 metre

Figure 2. Suggested model and parameters suiting the magnetic data. Notice the reversed profile direction.

KB5336

Depth (m)	Rock material
0-12	Till and weathered bed rock
12-118	Moderately fractured gneiss/amphibolite with raw fractures
118-177	Moderately fractured gneiss/amphibolite with fractures covered with chlorite

KB5450

Depth (m)	Rock material
0-9	Till and weathered bedrock
9-38	Gneiss with varied fracture frequency
38-74	Gneiss/amphibolite with varied fracture frequency, fractures covered with chlorite
74-155	Moderately fractured gneiss/amphibolite
155-169	Moderately fractured granite amphibolite with chlorite covered fractures
169-181	Moderately fractured gneiss

Table 1. The geologic information from the core drilled boreholes KB5336 and KB5450.

Between $x = 260$ and 390 metres there is an area where the resistivity is slightly lower than its surrounding. It is likely that this is a zone where fractures are present. From the core drilling KB5450 it can be seen that the fracture frequency is locally higher. The large volume of solid gneiss in combination with the small amount of fractures can explain the quite high resistivity value. At $x = 500$ metres and at 180 m.a.s.l. there is a section where both resistivity and IP is low. This might be explained by fractures where no weathering has occurred.

The magnetic mapping and modelling located the dolerite with high precision. At the same location but over a larger area there are also high IP effects. The dolerite's high IP effect can be explained by increased mineralization due to contact metamorphosis. In the surrounding rock there is also an increased fracturing which is highly water bearing giving slightly lower resistivity.

In the southern part of the resistivity profile a plume shaped section of low resistivity can be seen. The surface area above this plume is very wet with bogs and even a lake. The IP data show no effect in this zone which can be interpreted as water bearing fractures.

The geological interpretation of the 900 metre profile can be seen in figure 3 and is based on resistivity, IP and magnetic data combined with reference data from core drillings geological maps.

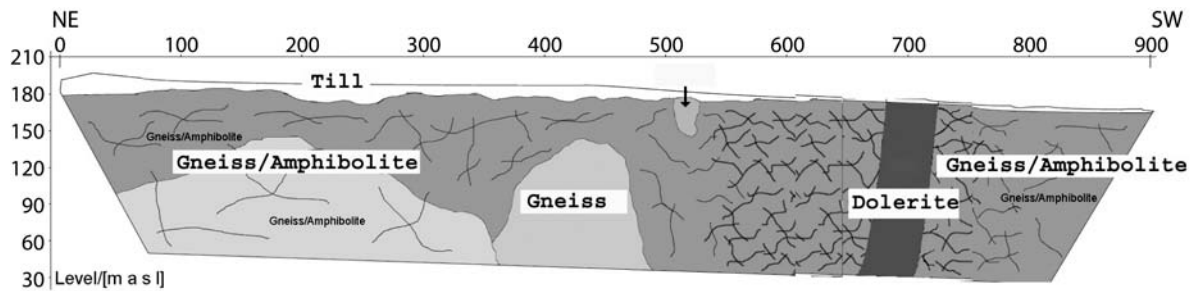

Figure 3. Detailed geological interpretation of the 900 metre profile.

Conclusion

Based only on the resistivity data the area can be divided into two sections. The northern most has a higher resistivity due to less fractures and the southern most has slightly lower resistivity and a higher amount of fractures. The IP data then adds information about the dolerite dyke and the magnetic data locates the dolerite with high precision.

The resistivity and IP complements each other very well since they focus on different specific characteristics. IP proved to be useful at locating dolerites and resistivity was useful for the general distribution of fractures. An advantage is that with the seven-channel Lund Imaging System both types of data can be measured in a fast and cost efficient way. It is notable that good quality IP data was achieved with as little as 40W transmitter power despite the relatively large depth of investigation. Magnetic measurements are a good supplement to pinpoint the exact position of the dolerite.

Reference data, e.g. core drillings and pumping test, is important for a detailed interpretation. In an early stage of the pre-investigations no information from drillings is usually available. But based on the general geologic information, resistivity and IP measurements recommendations can be given on where to drill in order to improve the geological model. It is clear that in this specific case the model would be improved by making drillings at $x = 250$ and $x = 600$. So based on the geophysical data the two drillings actually performed (KB5336 and KB5450) are not positioned optimally. One should ideally been placed so that information could be obtained about the zone with high IP effect.

References

- Dahlin, T., Bjelm, L., & Svensson, C. [1999] Use of electrical imaging in site investigations for a railway tunnel through the Hallandsås Horst, Sweden. *Quarterly Journal of Engineering Geology*, **32**, 163-172.
- Rønning, J. S. [2003] *Miljø- og samfunnstjenlige tunneler. Sluttrapport delprosjekt A, Forundersøkelser NGU, 2003.007.* (In Norwegian)
- Swedish Geological Survey [1981] *SGU Ser. Af nr 133. Flygmagnetiska Kartan. 4C Halmstad SV*
- Wikman, H. and Bergström, J. [1987] *Beskrivning till berggrundskartan Halmstad SV.* SGU (In Swedish)

Paper 2 Danielsen, B.E. and Dahlin, T. (2010)

**Numerical modelling of resolution and sensitivity of ERT in
horizontal boreholes.**

Journal of Applied Geophysics. 70: 245-254

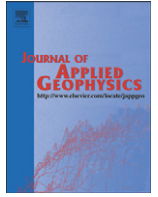

Numerical modelling of resolution and sensitivity of ERT in horizontal boreholes

Berit E. Danielsen*, Torleif Dahlin

Engineering Geology, Lund University, Box 118, 221 00 Lund, Sweden

ARTICLE INFO

Article history:

Received 6 August 2007

Accepted 20 January 2010

Keywords:

ERT

Horizontal boreholes

Numerical modelling

Arrays

2D sensitivity patterns

Non-parallel

Water filled boreholes

ABSTRACT

Resistivity in horizontal boreholes can give useful detailed information about the geological conditions for construction in rock, i.e. in front of a tunnel bore machine. This paper is an attempt to identify a suitable methodology for an effective measuring routine for this type of geophysical measurements under actual construction site conditions.

Prior to any measurements numerical modelling was done in order to evaluate the resolution of different electrode arrays. Four different arrays were tested; dipole–pole, cross-hole dipole–dipole, cross-hole pole–tripole and multiple gradient array. Additionally the resolution of a combination of cross-hole dipole–dipole and multiple gradient was assessed. The 2D sensitivity patterns for various arrangements of the cross-hole dipole–dipole and multiple gradient array were examined. The sensitivity towards inaccurate borehole geometry and the influence of water in the boreholes were also investigated. Based on the model study the cross-hole dipole–dipole array, multiple gradient array and a combination of these were found to give the best result and therefore were used for test measurements in horizontal boreholes. The boreholes were 28.5 m long and drilled 6.5 m apart. Prototypes of semi-rigid borehole cables made it possible to insert multi electrode cables in an efficient way, allowing fast measurement routines. These measurements were then studied to determine their accuracy and applicability. The results showed a high resistivity rock mass at the site. A transition from high resistivity to slightly lower resistivity coincides well with a change in lithology from gneiss–granite to gneiss. It is likely that the shotcrete on the tunnel wall is seen as a low resistivity zone. The measurements are a valuable tool, but further development of the cables and streamlining of measuring routines have to be performed before the resistivity tomography can be used routinely in pilot holes during construction in rocks.

© 2010 Elsevier B.V. All rights reserved.

1. Introduction

Pre-investigations are vital for time efficient, cost efficient and safe construction in rock. This requires sufficient knowledge about the rock properties such as water flow and stability. During tunnel drilling with a tunnel boring machine (TBM) probe drillings are made in front of the TBM on a regular basis. If the geology varies on a small scale, then probe drillings might not be representative of the rock mass between the boreholes. Thus the aim with this study is to investigate the possibility of using these boreholes for electrical resistivity tomography (ERT). ERT can be done between two or more boreholes and gives information about the rock mass between the boreholes. An important task is to make the whole measuring routine fast and efficient in order to avoid any delay for the TBM.

At geotechnical site investigations electrical imaging in combination with core drilling and geophysical logging has proven to be valuable for providing information about rock quality and detailed information on the engineering geological characteristics (Dahlin et al., 1999). Rønning

(2003) investigated the usefulness of surface based geophysical methods in the early stages of construction work. The conclusion is that 2D resistivity investigations often can indicate a weak zone, but this depends on the contrast between the resistivity of the weak zone and the surrounding rock. Electrical imaging made from the surface gives limited resolution at greater depths, and for more detailed information borehole measurements are required.

Previously ERT in vertical boreholes has proven useful for environmental investigations (Daily et al., 1995; Daily and Owen, 1991; Deceuster et al., 2006; French et al., 2002; Goes and Meekes, 2004; Guérin, 2005; LaBrecque et al., 1996). The method has also been demonstrated as economically efficient in wells drilled during geotechnical pre-investigation of a tunnelling site to obtain a 2D image of the resistivity close to a TBM (Denis et al., 2002). Here the method could detect vertical and horizontal changes in the soil. It thereby gave information about the geology between the wells. The measurements were done from the surface in sedimentary rocks while the measurements in this study are performed at tunnel level and in crystalline rock.

Even though model studies investigating the resolution of different electrode arrays have been done previously (Bing and Greenhalgh, 2000; Danielsen et al., 2005; Goes and Meekes, 2004) it was found necessary to perform a new study focussing on the specific scenario at

* Corresponding author. Engineering Geology, Lund University, Sweden.
E-mail address: berit.danielsen@tg.lth.se (B.E. Danielsen).

the tunnel site. The influence of water in the boreholes is investigated for a 3D model which is inverted as 2D. For a 2D case the model recovery of different electrode arrays is investigated in order to find the best suited array for the particular geology. The 2D sensitivity patterns for various arrangements of the cross-hole dipole–dipole and multiple gradient array are examined in order to clarify the modelling results.

Wilkinson et al. (2008) investigated the effects of geometric errors on cross-hole resistivity using analytical methods. In our case the importance of the geometry of the probe drillings was investigated through numerical modelling. The geometry of the boreholes is in reality very uncertain because they are drilled without precision. Therefore it is not known how parallel the holes actually are. What is interesting and relevant is to observe the magnitude of the error in data when data is inverted assuming that the boreholes are parallel. 3D inversion is possible, but given the data acquisition, it is not of relevance here.

This paper describes first the numerical modelling carried out to test how different electrode arrays recover structures in a specific geological setting. It is also investigated how uncertainty in the borehole geometry and water in the boreholes influences the results. For the numerical modelling the borehole separation and the electrode distance are equal to the actual measurements. Then the results from the numerical modelling are shown and discussed before the measurement using ERT in horizontal boreholes are presented. The measurements were carried out on an experimental stage. The first measurements were made in a tunnel where problems with poor

rock quality have delayed the work seriously. The boreholes used were similar to those drilled as probe drillings in front of the TBM. They were 28.5 m long and drilled 6.5 m apart, with a diameter of 64 mm. The results from the measurements are discussed before the conclusions from the modelling and the test measurements are given.

2. Numerical modelling

This section is divided into two parts. The first part comprises the setup of the numerical study and the second part describes the results. In the numerical study the model recovery and the sensitivity of different array types towards uncertainty in the geometry of the boreholes are assessed. Before the main modelling is done the influence of low resistive water in the boreholes is investigated. The essence with the modelling is to represent and test realistic field setup, inversion software and geological scenarios for this specific case.

In all cases two 19.5 m long boreholes separated with 6.5 m are modelled. The models resemble crystalline rock with high resistivity. In the first model there is an inclined low resistive feature e.g. water-bearing fracture zones. In the second model there is an inclined zone with a slightly lower resistivity than the matrix resembling a different lithology. The resistivity contrast is much lower than in the first model. The air-filled tunnel front is considered as having a very high resistivity.

The forward modelling is done in RES2DMOD (Loke, 2002) using a finite difference grid. The model is 50 m by 130 m (see Fig. 1). The grid size is 0.25 m by 0.25 m in the part of the model where the boreholes

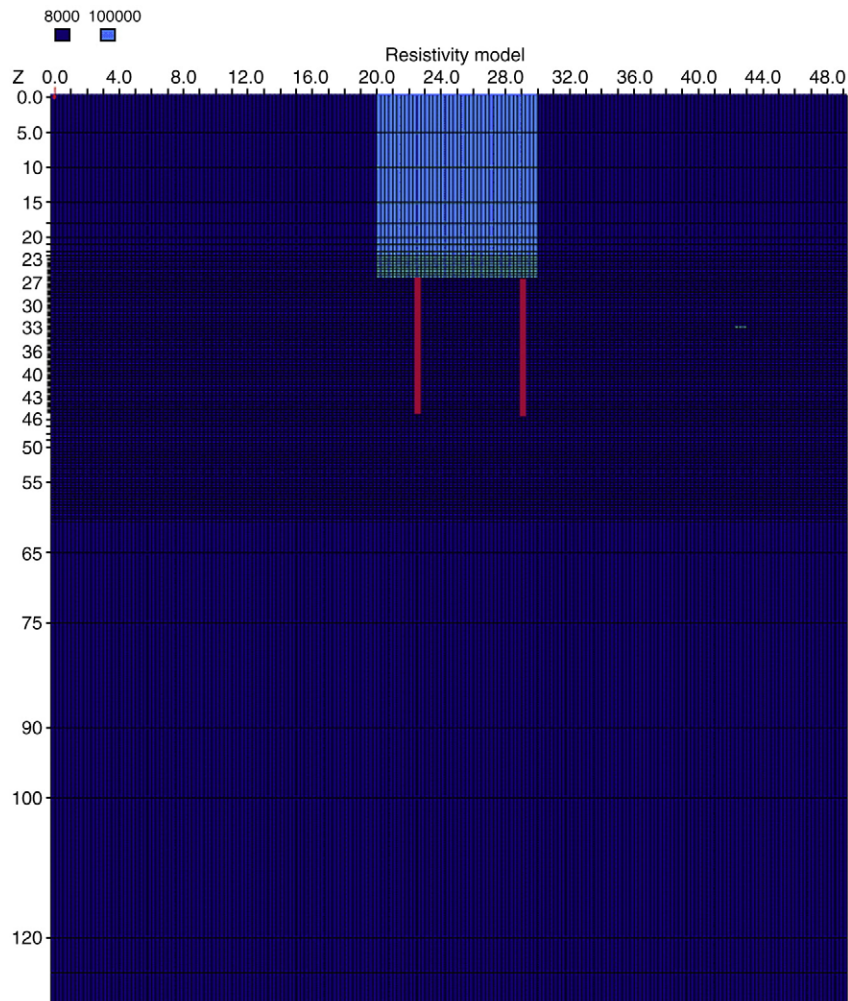

Fig. 1. The full model showing the boundaries. The red lines are the position of the boreholes. The grid size is 0.25 times 0.25 m in the section where the boreholes are positioned.

are. The boreholes are positioned at 22.5 m and 29 m and the electrodes are positioned from 26 to 45 m with 0.5 m spacing. Only the area of the models where there is sensitivity towards the geology is shown in the examples. Prior to inversion 5% random noise was added to the apparent resistivity data.

The inversion is done in RES2DINV (Loke, 2004a,b) with a robust inversion (L_1 -norm), by which the sum of the absolute values of the data misfit is minimized. The robust inversion was chosen because of the relatively sharp boundaries and large contrast in the resistivity (Loke et al., 2003). The residual between the forward calculated resistivities and the model response is used to verify the quality of the inversion, which in the case of robust inversion is calculated as the mean of the absolute values of the differences between the input data and the model response data, i.e. (Claerbout and Muir, 1973):

$$residual = mean((\underline{d}^{obs} - \underline{d}))$$

where \underline{d}^{obs} is a vector containing the measured data and \underline{d} is the vector of the forward response calculated from the model (pseudo-section). Multiplication with 100% gives the residual in percent. It is expected that the residual is in the same magnitude as the random noise added to the apparent resistivity, provided the inversion has been successful in finding a model in agreement with the data.

Four electrode arrays were tested (see Fig. 2); dipole–pole (AM–N), cross-hole dipole–dipole (AM–BN), cross-hole pole–tripole (A–BMN) (Goes and Meekes, 2004) and multiple gradient (Dahlin and Zhou, 2004). Then different combinations of gradient, AM–BN and A–BMN were tested but only the combination of AM–BN and multiple gradient is shown here. This is done because those two gave the best result when they were used alone. The dipole–pole (AM–N) and cross-hole dipole–dipole (AM–BN) are popular arrays in which Bing and Greenhalgh (2000) gave good results for environments where the resistivity contrast is a factor 10. In Goes and Meekes (2004) the pole–tripole (A–BMN) gave good results for tests done in unconsolidated sediments. In our case the arrays are tested for larger resistivity contrast in crystalline bedrock. The multiple gradient configuration has not previously been tested for borehole measurements. This is a surface

array which here is converted to a borehole array and is a combination of two single-hole datasets. The surface gradient array is addressed further in Dahlin and Zhou (2004). The number of data points (Table 1) influences the time used for measuring and inversion of the data. Because the time used for performing the measurements and the inversion are very important when used in front of a TBM the datasets are as small as possible. Both the gradient and the AM–BN have a relatively limited number of data points when implemented in the way done in our tests, i.e. with one s-factor for the gradient array and limited maximum separation between the dipoles.

The dipole–dipole configuration AB–MN was also tested at an initial stage but without satisfactory results, as was the case in the study by Bing and Greenhalgh (2000). Bing and Greenhalgh (2000) showed that the cross-hole pole–dipole A–MN, dipole–pole AB–M and the dipole–dipole AB–MN have singularity problem in data acquisition, giving many near-to-zero potential values. Therefore these alternatives are not considered here.

2.1. Resolution of different electrode arrays

Before the resolution of different electrode arrays is assessed the influence of water in the boreholes is roughly evaluated. During actual measurements water is present in the boreholes. The risk is that the water in the boreholes is so conductive that the current never will enter the bedrock but only pass through the water.

In reality the measurements are 3D but in this case only 2D inversion of the data are considered. Thus the forward modelling is made with RES3DMOD (Loke, 2001) and afterwards the data are extracted as 2D data and inverted in RES2DINV. Since finite difference is used (rectangular grid) the boreholes have to be approximated as having square cross section. The grid size is still 0.25 m by 0.25 m, but because the borehole is situated in a grid node, the boreholes have to be modelled as 0.5 m by 0.5 m even though the actual diameter of the boreholes is 0.06 m. The calculations are based on the equivalence principals i.e. the ratio between the layer thickness and the resistivity has to be constant, e.g. Parasnis (1986); Reynolds (1997). To obtain a correct total conductance of the grid cells representing the boreholes, the resistivity has to be approximately 100 times larger than in the actual case. The resistivity of the water in some wells at the investigation area is measured to be 50 Ω m on average. Therefore the resistivity of the boreholes in the model should be 5000 Ω m. This means that the contrast between the boreholes and matrix is very small and consequently the water in the boreholes is expected to be unimportant. To be on the safe side the modelling was carried out using a resistivity of 500 Ω m (i.e. the actual water resistivity is 5 Ω m) and a resistivity of 8000 Ω m for the matrix. If water in the borehole is critical for the measurements the very low resistivity would definitely influence the model recovery.

In Fig. 3 the 2D inversion of the 3D model shows that the very low resistivity of the boreholes is not recovered. For all four arrays the resistivity of the area between the boreholes is higher than in the forward model. One extremity is the AM–BN in Fig. 3c where the resistivity close to the boreholes is the same as for the forward modelling matrix. The other extremity is the gradient array (Fig. 3e)

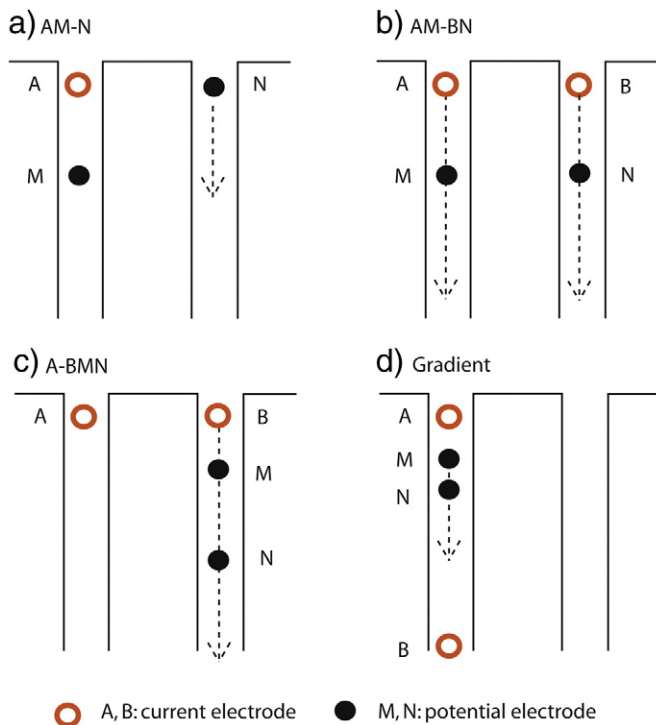

Fig. 2. Schematic layout of the discussed electrode configurations.

Table 1

Number of data points in four different electrode arrays and the combined array used in this numerical modelling. The arrays are generated using Matlab.

Array	Number of data points for 2D
Dipole–pole (AM–N)	640
Dipole–dipole (AM–BN)	268
Pole–tripole (A–BMN)	720
Gradient	248
Gradient + AM–BN	516

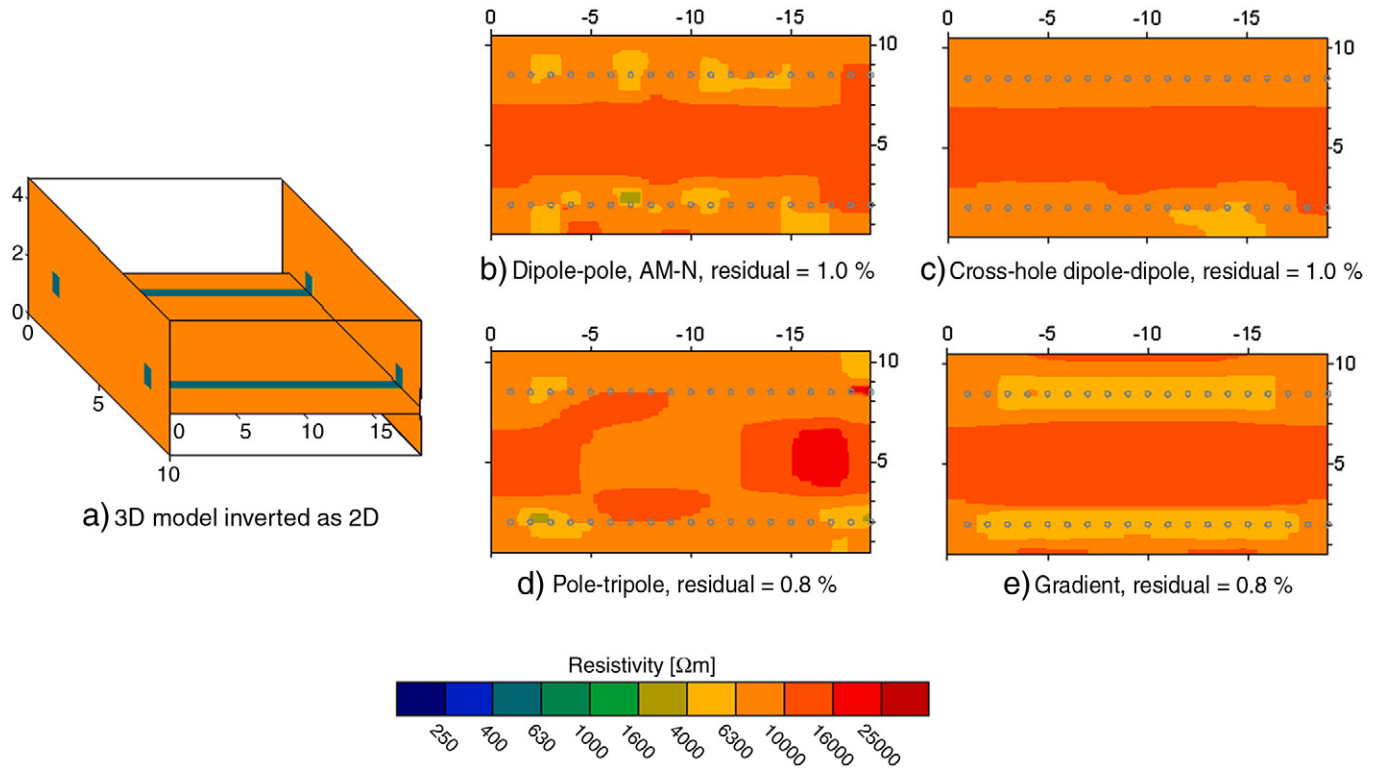

Fig. 3. a) The 3D model is inverted as 2D. The matrix has a resistivity of $8000 \Omega \text{ m}$ and the borehole has a resistivity of $500 \Omega \text{ m}$. Inversion results using b) dipole–pole (AM-N), c) cross-hole dipole–dipole (AM-BN), d) pole–tripole (A-BMN), e) multiple gradient. The distance is in metre.

where the resistivity close to the boreholes is lower than the matrix, but not as low as the true borehole resistivity. In between is the AM-N and A-BMN where there are some areas with lower resistivity and some with higher. But for none of the arrays the recovery of the matrix resistivity is influenced by the very low resistivity of the boreholes. Therefore the boreholes are assumed to be of minor importance with regards to the resistivity results and are excluded from the further study of the model recovery.

The first model used for the study of the model recovery has an inclined fracture zone with a resistivity of $300 \Omega \text{ m}$ in an $8000 \Omega \text{ m}$ matrix, see Fig. 4a. The high resistivity area in the left side of the model is the air-filled tunnel front. In the second model there is a wide inclined zone with a slightly lower resistivity ($3000 \Omega \text{ m}$) compared to the matrix ($8000 \Omega \text{ m}$). This resembles the contrast between two lithologies such as gneiss and gneiss-granite. Such a contrast is what can be expected in the field measurements.

The electrode arrays have a 0.5 m electrode spacing, thus there are 40 electrodes in each borehole. The total number of electrodes is larger than the maximum possible in the forward modelling program RES2DMOD. Therefore the generation of data is done twice with 1 m electrode spacing, where the second is displaced by 0.5 m compared to the first.

2.2. Sensitivity towards borehole geometry

The sensitivity towards the geometry of the boreholes is very important to assess because the probe drillings in front of a TBM are not drilled with great precision. In the worst case the accuracy is in the order of $1\text{--}2 \text{ m}$ on a 40 m long borehole. It is too expensive and time consuming to measure the geometry of the boreholes. As a consequence the electrodes are most likely in different positions when the data are measured than the position assumed in the data inversion. This means that when performing the inversion some inaccurate assumptions are made because the electrode geometry will be imprecise.

For modelling this scenario model 1 is used as in the section on electrode array resolution, where the electrodes in the left borehole diverge increasingly from a straight line with depth as illustrated by the red dots in Fig. 7a. The modelling is done for smaller and larger distances between the boreholes. The results were similar, thus only the latter is shown here.

The left borehole deviates 1 m in 19 m . Data is generated with these two non-parallel boreholes, but when inverting data, parallel boreholes are assumed. For evaluating the result the inverted data are compared with the ideal situation where the boreholes are in fact parallel when generating the data. This comparison is made by calculating the relative change. The difference in resistivity between the normal and diverging dataset is divided by the resistivity of the diverging dataset.

2.3. Results of the numerical modelling

2.3.1. The ability to recover the models using different arrays

Modelling the ability of the different arrays to recover the models showed differences in their ability to resolve the resistivity and location of the geological features. The results from the inversion of the synthetic model are shown in Figs. 4 and 5. Figs. 4a and 5a show the true models created in RES2DMOD. The models are seen from above with a left (L) and right (R) borehole.

In Fig. 4b–e the results are shown where only one array type is used on model 1. For all four arrays the correct thickness and position of the low resistivity zone are resolved accurately only at the boreholes. Therefore the best resolution is close to the electrodes. Except for the A-BMN the arrays have a slightly higher resistivity in a large area at the tunnel front. Experiments with adding a priori information to the data before inversion, e.g. fixed region and known boundaries, did not improve the result. The model residual is 7% for the AM-N whereas it is 3.8% for both AM-BN and A-BMN and 2.3% for the gradient array. As expected the model residual is in the same magnitude as the added noise (5%). There are cases of fitting the

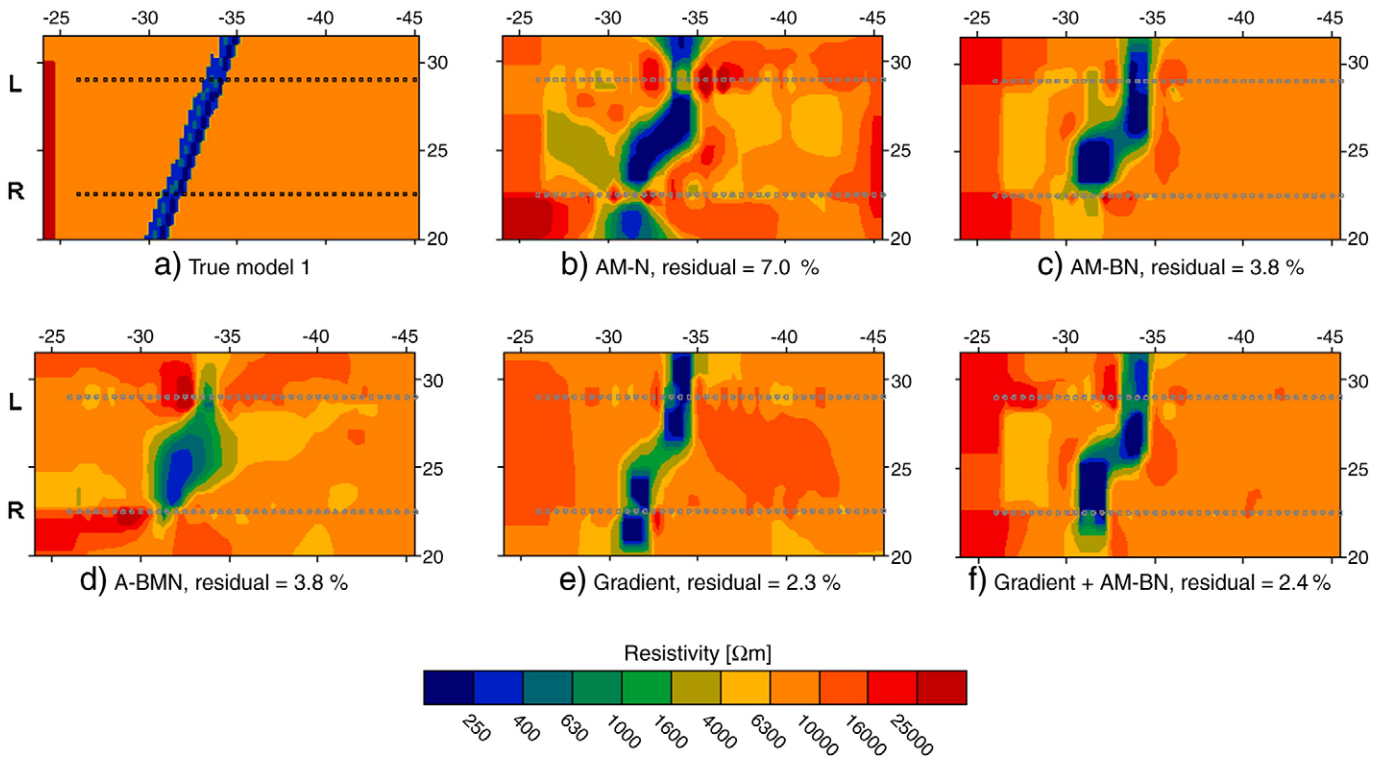

Fig. 4. a) The true model 1 made in RES2DMOD. Model of inclined fracture zone with a resistivity of 300 Ω m in a 8000 Ω m matrix. The model is seen from above with a left (L) and right (R) borehole. Inversion results using b) dipole–pole (AM-N), c) cross-hole dipole–dipole (AM-BN), d) pole–tripole (A-BMN), e) gradient, f) combination of gradient and cross-hole dipole–dipole. Black and grey dots are the electrodes in the boreholes. The distance is in metres.

model to the noise, which is seen as small islands (artefacts) of deviant resistivity at a single electrode, e.g. for the gradient array (Fig. 4e) at 27 m in the left borehole. This can also occur for field measurements but is easy to diagnose. The A-BMN in Fig. 4d has most difficulties in

resolving the low resistivity zone. The zone is more diffuse and has a higher resistivity at the edges of the model than the AM-N, AM-BN and multiple gradient arrays (Fig. 4b, c and e). These three arrays resolve the resistivity of the inclined zone well. With AM-N the inclined zone is

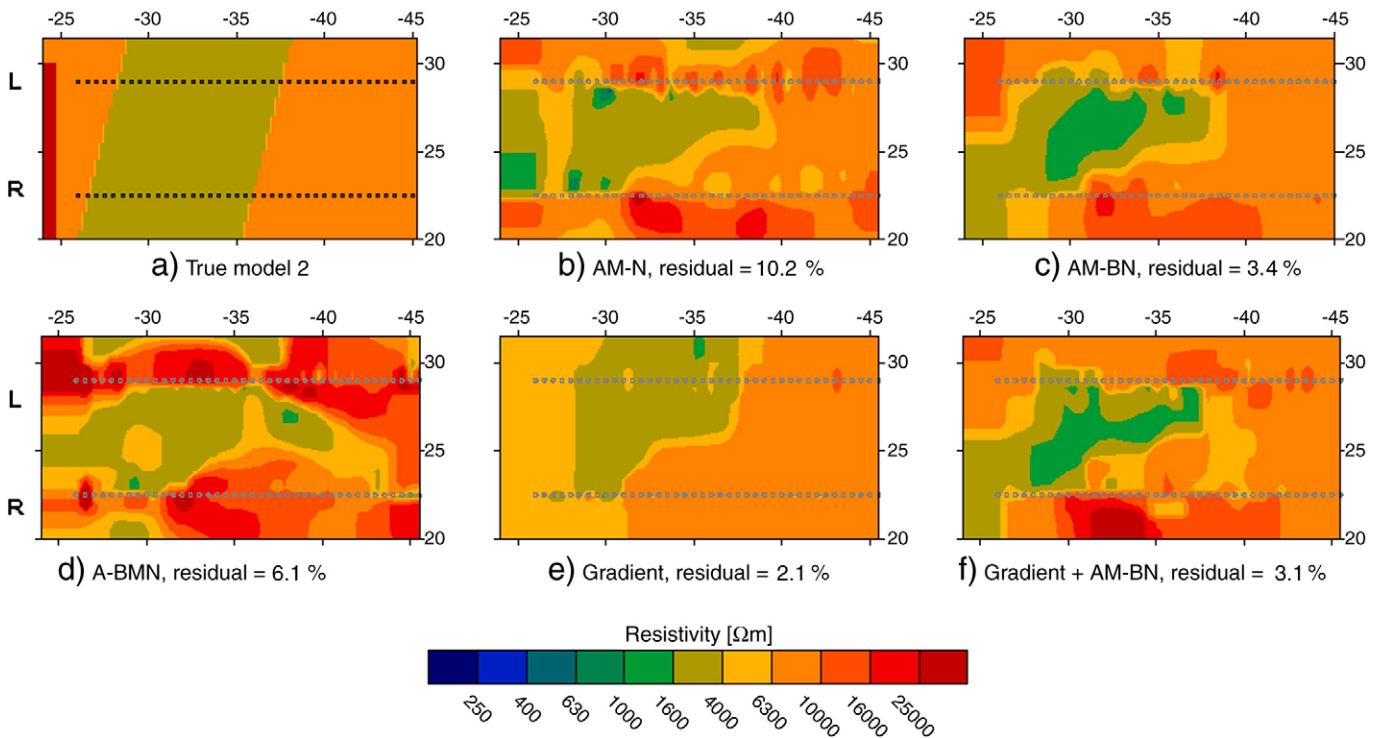

Fig. 5. a) The true model 2 made in RES2DMOD. Model of inclined zone with a resistivity of 3000 Ω m in a 8000 Ω m matrix. The model is seen from above with a left (L) and right (R) borehole. Inversion results using b) dipole–pole (AM-N), c) cross-hole dipole–dipole (AM-BN), d) pole–tripole (A-BMN), e) gradient, f) combination of gradient and cross-hole dipole–dipole. Black and grey dots are the electrodes in the boreholes. The distance is in metres.

resolved as continuous and with a homogeneous resistivity. The matrix is not well resolved and there are several artefacts, where data are fitted to noise. The multiple gradient array can resolve both the matrix and the inclined layer and the transition between high and low resistivity is particularly narrow. For the AM-BN array the inclined zone is diffuse and too large. Close to the tunnel front the resistivity of the matrix is too low. There are a few artefacts but the array resolves the matrix well.

The combination of AM-BN and multiple gradient array is seen in Fig. 4f. This combination has a residual of 2.4% and therefore fits the data well. The low resistivity zone appears in steps but is close to having the true resistivity. The transition from high to low resistivity is narrow. As in the case for the AM-BN array, the resistivity close to the tunnel front is too low.

In Fig. 5b–e the results are shown where only one array type is used on model 2. It is seen that AM-N, A-BMN and gradient can recover the resistivity of the wide low resistive zone in the area between the boreholes. The residual for AM-N is 10.2% which is considerably higher than for the other arrays. The AM-BN in Fig. 5c underestimates the resistivity of the low resistive zone. However, the geometry of the zone is not recovered well, especially not at the edges of the model. The residual is 3.4% for the AM-BN indicating a good fit to the data. The AM-N and AM-BN in Fig. 5b and c are very similar in how the true model is recovered. At the boreholes there are high resistive circular areas located around one or two electrodes which are considered to be artefacts i.e. fitting model to noise. The resistivity of the matrix is well recovered. The A-BMN in Fig. 5d is dominated by high resistivity close to boreholes. The resistivity of the matrix is clearly overestimated. The residual is 6.1% which supports the visual impression of a poor data fit. The gradient array in Fig. 5e has no artefacts and recovers the resistivity and geometry

of the different zones. It is only the area close to the tunnel front where the resistivity is slightly underestimated. For this array the residual is as low as 2.1% giving a good fit to the data.

In Fig. 5f the combination of gradient and AM-BN is shown. It is clear that the AM-BN dominates the result giving an underestimation of the low resistive zone and an overestimation of the resistivity in the bottom of the figure outside the right borehole. The residual is 3.1% which is a good data fit.

Fig. 6 shows the 2D sensitivity pattern for three AM-BN (a–c) and three gradient (d–f) electrode configurations. Other combinations were studied and these are some representative examples. Observe that the scale used for the AM-BN configurations is one magnitude larger than the scale used for the gradient configurations. It is quite clear that the AM-BN has a greater sensitivity between the boreholes. The sensitivity decreases quite rapidly when the separation between the current and potential electrodes increases. The gradient configuration has a smaller sensitivity between the boreholes, but has a much larger sensitivity close to the electrodes. Because of the different sensitivity patterns the arrays are expected to have different advantages in resolving geological structures, which the results in Figs. 4 and 5 show.

2.3.2. Sensitivity towards borehole geometry

Fig. 7 shows the results from modelling the sensitivity to different degrees of divergence from parallel. The figure shows the relative change instead of the resistivity image since the difference in the resistivity image is small. A change between -0.25 and 0.25 (white) indicates zones that show almost no difference between the case when the boreholes are perfectly parallel and when they are not. The red colour

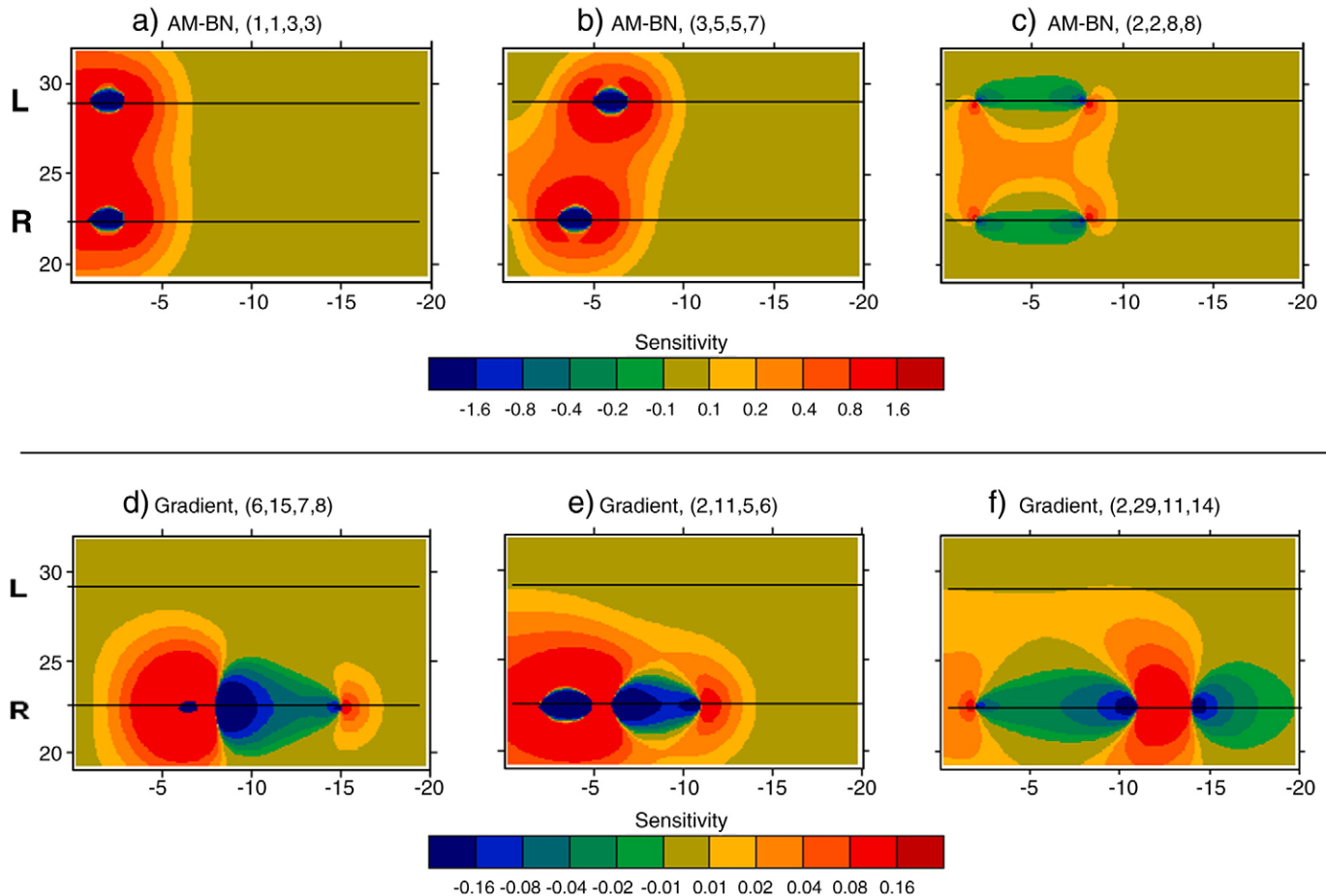

Fig. 6. The 2D sensitivity pattern in horizontal boreholes using AM-BN, a)–c), and multiple gradient, d)–f). The position of the electrodes (C1, C2, P1, and P2) is given in brackets. The horizontal black lines mark the position of the two boreholes. The distance is in metres. Notice the difference of a factor ten between the sensitivity of AM-BN and multiple gradient.

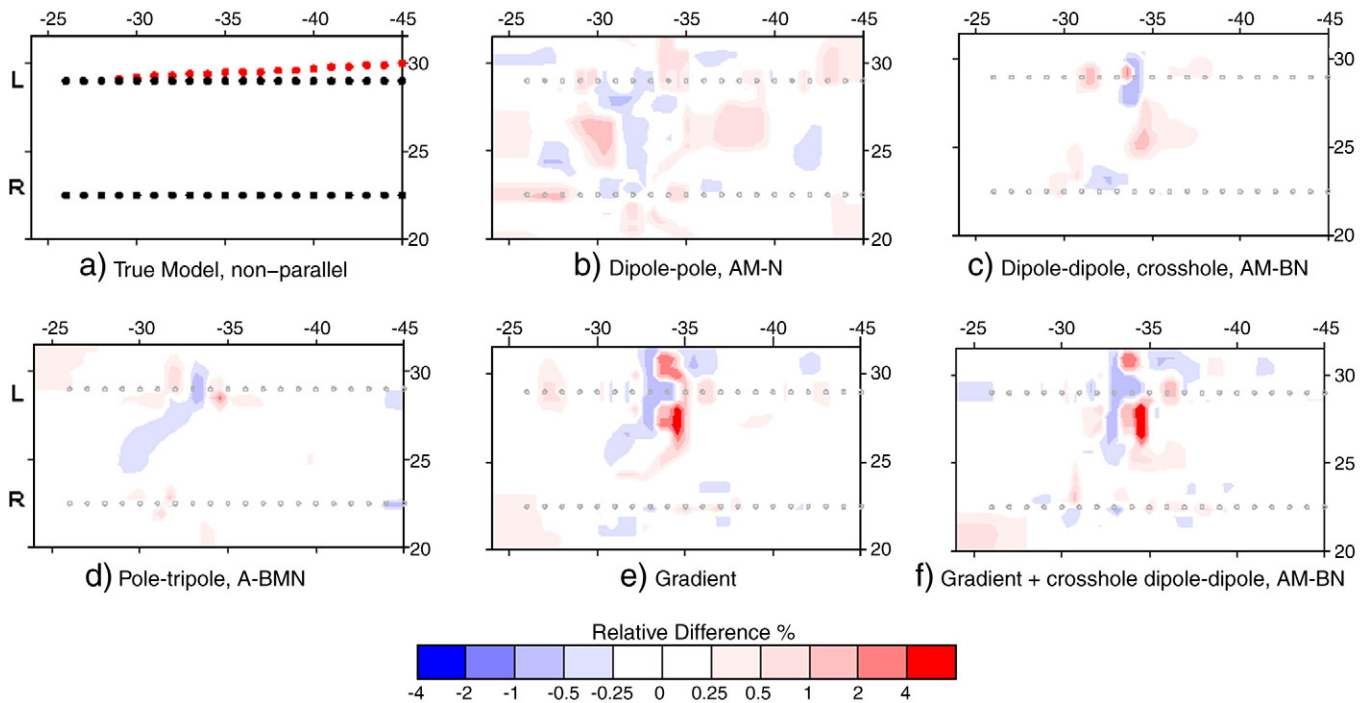

Fig. 7. The relative difference between inverted models with parallel and non-parallel boreholes. a) The red dots are the position of the electrodes while data are generated. The black dots are the position of the electrodes while the data are inverted. b) dipole–pole (AM-N), c) cross-hole dipole–dipole (AM-BN), d) pole–tripole (A-BMN), e) gradient, f) combination of gradient and cross-hole dipole–dipole (AM-BN). The grey dots are the electrodes in the boreholes assumed during inversion. The distance is in metres.

indicates that the resistivity obtained by the inclined borehole is smaller than for the parallel boreholes. The opposite is the case for the blue colour.

The AM-N array in Fig. 7b, is relatively sensitive towards changes in borehole geometry. The AM-BN array, Fig. 7c, and the A-BMN, Fig. 7d, are sensitive close to the low resistivity zone but are generally insensitive elsewhere. The largest difference is seen with the gradient array in Fig. 7e. At the low resistivity zone in the left borehole the relative difference is large. The combination of gradient and AM-BN sums up the differences from the individual arrays (Fig. 7f).

3. Discussion of the numerical modelling

Generally the numerical modelling showed that the area best recovered is close to the electrodes for all the arrays.

The best recovery of the resistivity and position of the geological structures is obtained with multiple gradient array, AM-BN and a combination of AM-BN and multiple gradient array. These arrays have the lowest residual (~2–6%). In all cases the matrix and the low resistivity close to the boreholes are well resolved. Even though the resistivity contrast in model 2 is small the arrays recover the model well. This is useful in the actual case where there is expected to be a difference in lithology and therefore a small difference in resistivity. The AM-BN is good at resolving the resistivity of the matrix between the boreholes but there are some artefacts. The study of the 2D sensitivity patterns for the AM-BN and gradient array supports these observations. The gradient array has a smaller sensitivity between the boreholes than the AM-BN. Results from other modelling carried out, but not shown here, emphasise that the resolution between and outside the boreholes is limited for the gradient array. This is probably due to the fact that it is two single-hole data sets merged together. It can be expected that it creates symmetry problems as described in Tsourlos et al. (2003). This has to be addressed further in the future. By combining the two arrays the structures are slightly better resolved. The

AM-N has a high residual (7–10%). The array resolves the low resistivity zone, but not the matrix where there are quite a number of artefacts. The A-BMN has a relatively high residual for model 2. The configuration does not have the same resolution of this geological setting as AM-N, AM-BN and multiple gradient configurations.

The signal to noise ratio for the different arrays is important to consider when evaluating the results. The geometric factor is calculated for each electrode configuration because it is inversely proportional with the signal to noise ratio (Loke, 2004a,b). The geometrical factor for the A-BMN differs between 20 and 10,000 whereas AM-BN mainly differs between 10 and 1000. Even though A-BMN has some electrode configurations with high signal to noise ratio, there are also many configurations with low signal to noise ratio. The gradient array has a geometrical factor between 25 and 250 which is the lowest for the array tested. Therefore the gradient also has the highest signal to noise ratio. This influences the resolution of the models and contributes to the overall impression of the arrays' performance.

The study of the sensitivity of the arrays towards the borehole geometry showed that the smallest difference is obtained using the AM-BN or A-BMN. The sensitivity towards geometry errors was visualized by using the relative difference instead of the actual inversion model. This was done because the difference is difficult to distinguish when comparing the inversion models. This demonstrates that the geometry problem produces only small changes in the resistivity values. In most cases the difference is largest close to the low resistivity zone. A limitation in the study is that only one of the boreholes is deviates because it is not possible to model two inclined boreholes in RES2DMOD. In reality the geometry is probably that both boreholes are deviating. In such a case there will be a larger difference, but it is expected that for the array types discussed, this will produce only a minor difference.

With the particular application in mind, i.e. measurements in front of a TBM, it is very important that the measurements and inversion is fast. The measurements can only be performed when the TBM is

standing still and the information about the geology is needed before the production can be resumed. Therefore it is crucial with fast data acquisition and inversion, hence an approach that requires as few data points as possible without compromising resolution and reliability is desired. This is a critical factor because, as shown in e.g. [Dahlin and Loke \(1998\)](#), the data density is important for resolving certain structures. With the computer power available the data is inverted within 5 min, and with faster computers this reduces so it is of minor importance. The time used on the data acquisition depends on e.g. the instrument, number of stacks, measurement delays and integration time. These factors depend on the field conditions and can only be determined at the field site. A rough assessment for a 4 channel instrument and combination of gradient and AB-MN ([Table 1](#)) would give 129 measurements. Each measurement takes between 2 and 20 s, depending on selected parameters and site conditions, which means that the whole acquisition can take between 4 and 40 min. In addition there is a certain mobilization time for getting the cables ready for measuring. This rough estimation shows that several factors influence the time used on measurements. Still the optimization of the number of data points should be addressed further in future work.

Based on the results from the numerical modelling the AM-BN and the gradient arrays were used in the field test measurements in the horizontal boreholes. It is then possible to combine the different datasets before inversion. Even though [Goes and Meekes \(2004\)](#) showed good results for the A-BMN, it did not resolve the geology particularly well for the models studied and has a high residual. The A-BMN also had a low signal to noise ratio. Thus the A-BMN was not used for the actual measurements in the boreholes. The AM-N array did not prove to be good at resolving the matrix giving very high residual, and was also sensitive towards unknown borehole geometry. In addition the array is more complicated to use in the field, because of the need for a remote electrode.

4. ERT in horizontal boreholes

Horizontal boreholes raise several practical questions, i.e. how to get the electrode cables into the boreholes. For solving this problem a prototype of a semi-rigid cable has been developed, using a thin fibreglass rod to create rigidity, [Fig. 8](#). A further requirement is that the cables can be wound up so that they can be handled in confined spaces. To avoid getting stuck in the boreholes the cables have to be streamlined. The need to have streamlined cables conflicts with the requirement for adequate electrode contact with the borehole walls. To overcome this both test holes were drilled with a couple of degrees inclination downwards in order to keep water in the holes thus creating better electrode contact. The inclination also makes it possible to pour water into the hole if no water is present naturally.

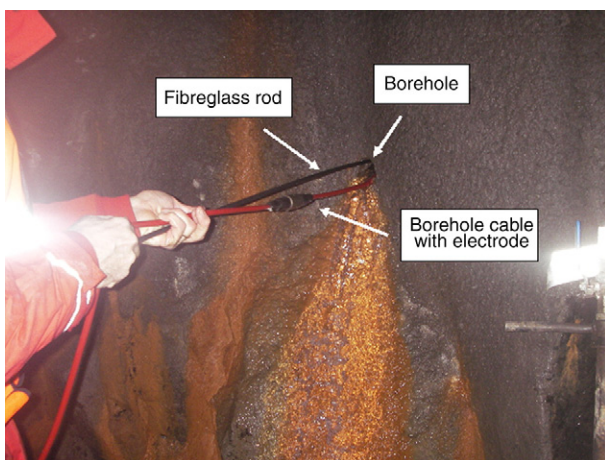

Fig. 8. Photograph of a borehole cable with the thin fibreglass rod.

For the test measurements the electrode spacing was 1 m, but by pulling back the electrode cable half a metre after the first measurement and then measuring a second time the data interval was reduced to 0.5 m. It should be noted, however, that any measurements with 0.5 m electrode spacing could not be done.

For the measurements the Lund Imaging system was used, in this case consisting of Terraohm RIP924, ABEM Electrode Selector ES10-64C and ABEM SAS2000 Booster. The same array protocols were used in field as in the numerical modelling ([Table 1](#)). Due to the high contact resistance it was only possible to transmit between 2 and 20 mA. There was a delay on 500 ms between each measurement and the integration time was 600 ms. The minimum number of stacks was 2 and the maximum number was 4. The maximum variation coefficient between the stacks was 1%.

The inversion program RES2DINV does not allow viewing and editing of the borehole resistivity data before inversion. Therefore the format of the borehole data files was modified to make it possible to plot data ([Fig. 9](#)) in pseudosections in the data visualization software Erigraph and to edit data in RES2DINV. Erigraph can e.g. plot pseudosections from Lund Imaging System and is distributed by ABEM Instrument AB. By plotting the data as a pseudosection an overview of the overall data quality is given before editing in RES2DINV, which can facilitate the omission of outliers from the measured data.

5. Results and discussion of measurements in horizontal boreholes

The prototype of the stiff electrode cables was effective and easy to use in practice, but problems still occurred during the measurements. One cable got stuck in a borehole and had to be left in the hole during the first stages of developing the prototype. This stimulated the development of a cable without any protuberances. Still it does not completely prevent the problem from recurring. Another problem was that a borehole collapsed before the measurements were done. As a consequence measurements were performed in holes of different length which gives an asymmetrical result. In this particular case the boreholes were re-drilled and the measurements could be performed in holes of equal length. However, it is too expensive and time consuming to re-drill the holes when the measurements are being used for regular production purposes.

The inversion of the borehole data gave a residual of 5.8% for the cross-hole dipole–dipole and 14.7% for the gradient array. The inversion of the combined data set gave also a residual of 14.7%.

[Fig. 10](#) shows the inversion results of the resistivity measurements with the different array types and the combined data. The grey circles mark the positions of the electrodes in the two boreholes. The innermost electrode in both boreholes is positioned at 1 m and the tunnel wall is at 28.5 m. The results are viewed from above with the

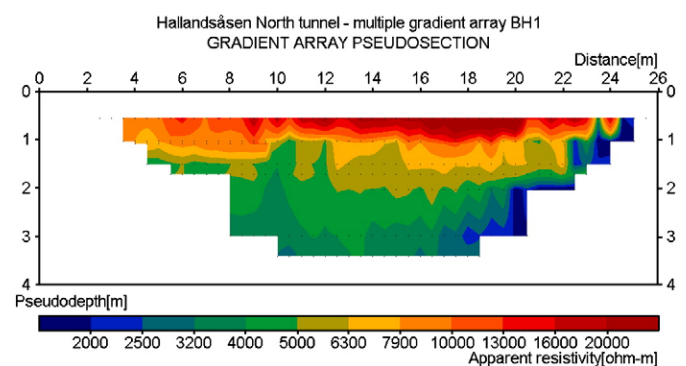

Fig. 9. An example on measured data plotted as a pseudosection. The example is the gradient data measured in one borehole plotted in Erigraph.

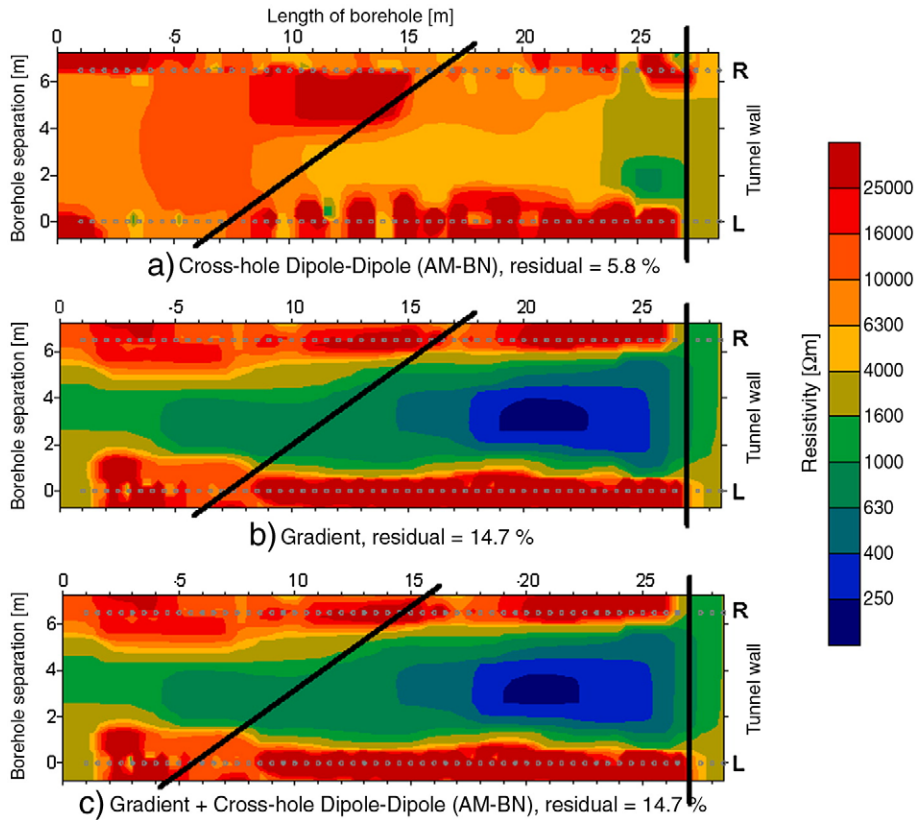

Fig. 10. The inversion results from the resistivity measurements using different electrode arrays. The boreholes are seen from above with the tunnel wall to the right in the figure. The left borehole, seen from the tunnel, is marked with *L* and the right borehole with *R*. The lines show probable structures. a) Cross-hole dipole-dipole array, b) Gradient array, c) Combination of gradient and cross-hole dipole-dipole. Grey circles mark the position of the electrodes. The electrode separation is 0.5 m.

tunnel wall to the right in the figures. The left borehole, seen from the tunnel, is marked with *L* whereas the right borehole is marked with *R*.

For all three results the resistivity close to the borehole is higher than 16,000 Ω m. The inversion result of the combined data set looks very much like the result using the gradient array. This is also confirmed by the absolute error value. Why the gradient array is so dominant has to be investigated in future work. Even though the results have a large difference in the resistivity of the area between the boreholes there is still a trend in the resistivity images. The line from 5 m in the left borehole to 17 m in the right borehole marks a transition from high resistivity to a slightly lower resistivity. Close to the tunnel wall the resistivity is low in all three examples.

As reference data for the interpretation of the resistivity data the information from a horizontal core drilling, called NA01, is used. NA01 is

drilled perpendicular to the two boreholes and thereby parallel to the tunnel wall and therefore the information cannot be applied directly. The drilling report (left out here) showed that where it crosses the two test boreholes the lithology is gneiss. The geological structures here intersect the tunnel at an angle of 65–70°. This information together with the data from NA01 gives a rough estimated position of fractures and formation changes in the test boreholes, see Fig. 11.

By comparing the result from Fig. 10 with the estimated position of the structures found in NA01, it is clear that no fractures are resolved by the resistivity method. The fractures are presumably present but are not visible in the data. The fractures might be too narrow to be resolved with this electrode spacing and borehole separation. The data are most likely also influenced by 3D effects.

The transition from high resistivity to lower resistivity is probably a change in lithology from gneiss-granite to gneiss. The mineral

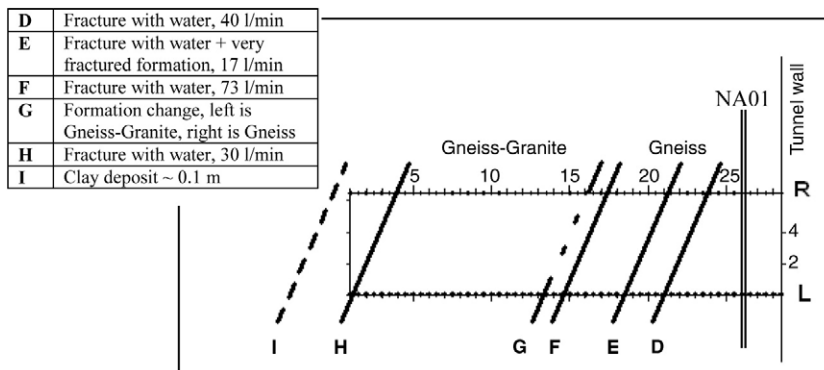

Fig. 11. The estimated projected position of the structures found in NA01. The nature of these fractures is seen in the table at the left. The approximated position of NA01 is shown with two parallel lines 3 m from the tunnel wall.

composition of the rock mass is different and probably most important is that the gneiss-granite contains less fractures than the gneiss (Wikman and Bergström, 1987). This would explain why the gneiss-granite has a higher resistivity than the gneiss. The low resistivity zone close to the tunnel wall is most likely caused by the shotcrete at the tunnel wall, which contains metal fibre reinforcements. In addition there might be rock reinforcements, e.g. rock bolts, which could affect the result. In an actual production phase shotcrete and rock reinforcement will not influence the measurements when performed in the tunnel front because they will not yet have been applied.

The numerical modelling showed that the water in the boreholes should not influence the resolution of the different arrays. The very high resistivity at the boreholes suggests that the measurements not are influenced by the water in the boreholes.

The residual for the measurements proved to be acceptable for the cross-hole dipole–dipole whereas for the gradient array it is rather high, but still acceptable. The high error could be expected because of the high resistive environment, limiting the transmitted current.

6. Conclusions

Probe holes are drilled up to 40 m ahead of a TBM in order to investigate the rock conditions and the amount of water. If the geology is highly variable, representative information might not be obtained by drilling two or three probe holes because the area between the probes might be quite different. By performing small scale resistivity tomography between the boreholes a better image of the geological setting would be obtained and the operator would be better prepared of the upcoming 40 m ahead. The additional information might contribute to a more effective TBM advance. A development of an ERT system for horizontal boreholes is therefore important.

The numerical modelling showed that the best resolution of the inclined fracture zone was obtained using the multiple gradient array and a combination of AM-BN and multiple gradient. In addition the AM-BN proved to be the most insensitive towards non-parallel boreholes. The sensitivity pattern made it clear that the AM-BN has the largest sensitivity between the boreholes, while the gradient has the largest sensitivity close to the electrodes. The gradient array did also have the highest signal to noise ratio. This result can be used in the optimization of the protocols. The main conclusion was that AM-BN and multiple gradient array are the best for the actual measurements. The numerical modelling also showed that the water filled boreholes should not influence the results much.

The measurements in test boreholes showed that it most likely is possible to resolve the change from gneiss to gneiss-granite. The resistivity is low close to the tunnel wall because of the shotcrete. The very high resistivity at the boreholes proved that the low resistivity water in the boreholes did not have any visible effect on the result.

An important outcome of this study was that the prototype of the semi-rigid cable proved to work well. For production measurements it is suggested that electrode cables with an integrated glass fibre rod would work well. Measuring of reciprocal data for data quality assessment is suggested at least in a test and development phase. For a better data evaluation it would be worthwhile to obtain accurate reference data by making measurements in core drilled boreholes so that the resistivity results can be compared to the borehole logs. A further optimization of the protocol files is also vital, and in particular a study of the different 2D sensitivity patterns is considered to be essential. It would be interesting to do the measurements between

more than one borehole in order to reduce the distance between the holes. In this case 3D inversion would be useful.

Acknowledgements

The work behind this paper was funded by SBUF (Development Fund of the Swedish Construction Industry), Banverket (Swedish Rail Administration) and Skanska-Vinci HB (SBUF project 11601), which is gratefully acknowledged. Drilling of test boreholes and invaluable logistic support during the field tests were provided by Skanska-Vinci HB. Our gratitude also goes to M.H. Loke for modifications made in Res2DMOD which made it possible to work with non-parallel boreholes. The comments and suggestions from two anonymous reviewers have significantly improved the quality of the paper.

References

- Bing, Z., Greenhalgh, S.A., 2000. Cross-hole resistivity tomography using different electrode configurations. *Geophysical Prospecting* 48, 887–912.
- Claerbout, J.F., Muir, F., 1973. Robust modelling with erratic data. *Geophysics* 38, 826–844.
- Dahlin, T., Loke, M.H., 1998. Resolution of 2D Wenner resistivity imaging as assessed by numerical modelling. *Journal of Applied Geophysics* 38, 237–249.
- Dahlin, T., Zhou, B., 2004. A numerical comparison of 2D resistivity imaging with 10 electrode arrays. *Geophysical Prospecting* 52, 379–398.
- Dahlin, T., Bjelm, L., Svensson, C., 1999. Use of electrical imaging in site investigations for a railway tunnel through the Hallandsås Horst, Sweden. *Quarterly Journal of Engineering Geology* 32, 163–172.
- Daily, W., Owen, E., 1991. Cross-borehole resistivity tomography. *Geophysics* 56 (8), 1228–1235.
- Daily, W., Ramirez, A., LaBrecque, D., Barber, W., 1995. Electrical resistance tomography experiments at the Oregon Graduate Institute. *Journal of Applied Geophysics* 33 (4), 227–237.
- Danielsen, B.E., Dahlin, T., Danielsen, J.E., 2005. Model study of the resolution of resistivity tomography with different electrode arrays. 11th European Meeting of Environmental and Engineering Geophysics.
- Deceuster, J., Delgranche, J., Kaufmann, O., 2006. 2D cross-borehole resistivity tomographies below foundations as a tool to design proper remedial actions in covered karst. *Journal of Applied Geophysics* 60 (1), 68–86.
- Denis, A., Marache, A., Obellianne, T., Breyse, D., 2002. Electrical resistivity borehole measurements: application to an urban tunnel site. *Journal of Applied Geophysics* 50 (3), 319–331.
- French, H.K., Hardbattle, C., Binley, A., Winship, P., Jakobsen, L., 2002. Monitoring snowmelt induced unsaturated flow and transport using electrical resistivity tomography. *Journal of Hydrology* 267, 273–284.
- Goes, B.J.M., Meeke, J.A.C., 2004. An effective electrode configuration for the detection of DNAPLs with electrical resistivity tomography. *Journal of Environmental & Engineering Geophysics* 9 (3), 127–142.
- Guérin, R., 2005. Borehole and surface-based hydrogeophysics. *Hydrogeology Journal* 13 (1), 251–262.
- LaBrecque, D.J., Ramirez, A.L., Daily, W.D., Binley, A.M., Schima, S.A., 1996. ERT monitoring of environmental remediation processes. *Measurement Science and Technology* 7 (3), 375–383.
- Loke, M.H., 2001. RES3DMOD ver. 2.1 M.H.Loke on www.goelectrical.com.
- Loke, M.H., 2002. RES2DMOD ver. 3.01 M.H.Loke on www.goelectrical.com.
- Loke, M.H., 2004a. RES2DINV ver. 3.54 M.H.Loke on www.goelectrical.com.
- Loke, M.H., 2004b. Tutorial: 2-D and 3-D electrical imaging surveys: M.H.Loke on www.goelectrical.com.
- Loke, M.H., Acworth, I., Dahlin, T., 2003. A comparison of smooth and blocky inversion methods in 2D electrical imaging surveys. *Exploration Geophysics* 34, 182–187.
- Parasnis, D.S., 1986. *Principles of Applied Geophysics*. Chapman and Hall.
- Reynolds, J.M., 1997. *An Introduction to Applied and Environmental Geophysics*. John Wiley & Sons.
- Rønning, J.S., 2003. Miljø- og samfunnstjenlige tunneler. Sluttrapport delprosjekt A, Forundersøkelser NGU. Report nr. 2003.077. (In Norwegian).
- Tsourlos, P., Ogilvy, R., Williams, G., 2003. Time-lapse monitoring in single boreholes using electrical resistivity tomography. *Journal of Environmental and Engineering Geophysics* 8, 1–14.
- Wikman, H., Bergström, J., 1987. *Beskrivning till Berggrundskartan Halmstad SV* Swedish Geological Survey, Uppsala. (In Swedish).
- Wilkinson, P.B., Chambers, J.E., Lelliott, M., Wealthall, G.P., Ogilvy, R.D., 2008. Extreme sensitivity of crosshole electrical resistivity tomography measurements to geometric errors. *Geophysical Journal International* 173, 49–62.

Paper 3 Danielsen, B.E. (2010)

**Borehole geophysics provides detailed information in pre-
investigation for rock tunnel construction.**

Submitted for publication to *Canadian Geotechnical Journal*

Borehole geophysics provides detailed information in pre-investigation for rock tunnel construction

Berit Ensted Danielsen

Engineering Geology, Lund University, John Ericssons väg 1, S-223 63 Lund, Sweden

Abstract

Borehole geophysics is a natural part of exploration for new oilfields and ore deposits, but as part of pre-investigation for rock tunnel construction it is often diminished. Even the most basic logging probes can give detailed information about the lithology change, fractures and weathering of crystalline bedrock. Additionally it gives continuous *in situ* measurements which are of great value when there is no core recovery.

In two core drilled boreholes at the Hallandsås Horst, Sweden, borehole geophysics was performed in order to evaluate the resolution, properties and usefulness of the method. For evaluation the logs were compared with the cores. The result suggests that logging of non-cored boreholes can reveal useful information especially when there are cored drill holes to correlate with. As an example logging measurement was done in a percussion drilled borehole in the same area. The reference from the core drilled holes was then used for the interpretation.

Borehole geophysics provides a large number of information about the rock properties which are of great importance in pre-investigation for rock tunnel construction. It can also be recommended that borehole geophysics is done in the cheaper percussion drilled holes and thereby being a good alternative to the expensive core drilled holes.

Keywords: borehole geophysics, logging, core drillings, percussion drilling, pre-investigation

Introduction

Different drilling methods are widely used in pre-investigations for rock tunnel construction. Core drillings are made in order to obtain undisturbed rock samples providing information about rock mechanical properties, lithology, fracturing and weathering e.g. Schepers et al. (2001). ISRM (1981) suggests geophysical logging of boreholes to determine the geometry of major subsurface structural discontinuities. In Takahashi et al. (2006) ISRM gives guidelines for how to use borehole geophysics to achieve useful and valuable outputs for rock engineering projects. Rafat et al. (2001) present examples on how borehole geophysics can contribute with information about lithology, structural and rock mechanic information. The borehole geophysics is also used to calibrate the results from surface geophysics and should therefore be an integrated part of the pre-investigation for rock construction.

Strictly speaking borehole logging is an alternative or supplement to the analysis of cores and cuttings. Although often preferred because of the possibility of continuous analysis of the rock formation over a given interval, economic and technical problems limit the use of cores. Coring takes

time, and is therefore expensive. A core drilling is about 4–5 times as expensive as a percussion drilling per meter (Swedish prices 2010, without mobilization/demobilization, L. Bjelm (personal communication, 2010)). In many soft and friable rocks, e.g. clay weathered rock, it might only be possible to recover part of the cored interval. Geophysical logging gives continuous in situ measurements which are of great value when there is no core recovery. Cuttings, extracted from e.g. percussion drillings, are one of the major sources of subsurface sampling. However, the reconstruction of the lithological sequence from cuttings is imprecise due to the problem of associating depth with any given sample. It also demands very skilled personnel to determine the lithology and weathering from the small cutting samples. Although most well logging techniques do not give access to the physical rock samples, they do, through indirect means, provide continuous, in situ measurements of parameters related to lithology and other rock properties of interest (Ellis and Singer 2007).

The scope of this paper is to show that borehole geophysics can give detailed information about the lithology, fracturing and weathering of crystalline bedrock. It can also be recommended that borehole geophysics is done in the cheaper percussion drilled holes and thereby being a good alternative to the expensive core drilled holes.

The geophysical borehole sonds can detect different physical properties, so a combination of several logs is the optimal (e.g. Takahashi et al. 2006). In the particular case described here the resistivity logs detects fracture and weathered zones. The natural gamma log detects amphibolites and dolerite dikes in the surrounding gneiss. The caliper log gives good indications on fractures. These logging probes are the most basic and are standard in most logging operations.

The study area is situated in Southern Sweden, figure 1, where the construction of Hallandsås Railway Tunnel has been problematic with delays and raised budget as a consequence. One of the problems has been variations in the mechanical properties of the rock. A deep weathering of the rock has in some parts resulted in zones in the bedrock where the mechanical properties are similar to clay. In other parts of the rock, fractures carry groundwater under a high pressure. Even though borehole geophysics is a useful method, only a few boreholes at the Hallandsås Railway Tunnel are surveyed with geophysical logging (Dahlin et al. 1999).

In two core drilled boreholes at the Hallandsås Horst, geophysical logging was performed in order to evaluate the resolution and usefulness of the method. For evaluation the logs were compared with the cores. The result suggests that logging of non-cored boreholes, might reveal very useful information especially when there are some cored drill holes to correlate with. As an example geophysical logging was done in a percussion drilled borehole in the same area. The experience from the logging in the core drilled holes was then used for the interpretation.

In the following the geological setting of the investigation area is presented prior to a method description. A brief introduction to the logging probes used in the measurements is given. The results are presented together with a discussion and finally the results are summarized in the conclusion.

Geological setting

The Hallandsås Horst, figure 1, is the result of tectonic activities, which has been going on at least since Silurian time. It is part of the Tornquist Zone and the uplifted blocks have a NW-SE orientation.

The Tornquist Zone is a tectonic element which stretches all the way to the Black Sea (Wikman and Bergström 1987). The Hallandsås Horst is 8-10 km wide, 60-80 km long and reaches an elevation of 150 to 200 m in the investigated area.

Gneisses of presumably intrusive origin dominate the area, whereas sedimentary rocks cover minor areas. Amphibolites of several generations occur and the oldest are often seen as minor layers or schlieren parallel to the layering in the gneiss. The younger amphibolites have mostly distinct contacts and cut across the structures of the older bedrock. These younger dykes often run in the NNE-SSW direction (Wikman and Bergström 1987).

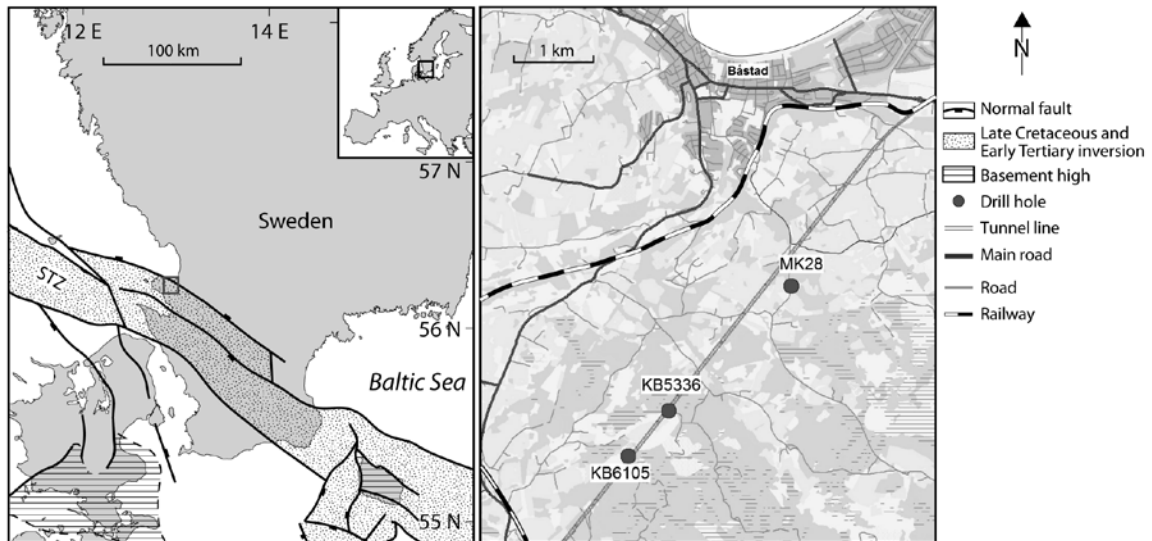

Figure 1. Left: Map of Southern Sweden showing the position of the investigation area and the outline of the Tornquist Zone (STZ). Right: The position of the three logged boreholes along the tunnel line. The core drilled holes are KB5336 and KB6105. The percussion drilled hole is MK28. Maps are modified from Graversen (2009), Lantmäteriverket (2001) and Liboriussen et al. (1987).

The dominant faults correspond to the Tornquist Zone and are oriented in NW-SE direction. Another younger system has a NNE-SSW direction. The bedrock is intruded by a set of younger dolerite dykes with their trend parallel to the Scanian horsts. These NW-dolerites are steeply dipping dykes that can have a width up to 50 m (Wikman and Bergström 1987). They are seen as very distinct linear positive anomalies on the aeromagnetic map (Swedish Geological Survey 1981). On the aeromagnetic maps it is also possible to see the NNE and NW fault systems because they disconnect the positive anomalies associated with the dolerite dykes (Wikman and Bergström 1987).

The extensive deep weathering of the bedrock began during Triassic time and periodically continued during the Cretaceous. This resulted in a weathering mainly to kaolinite. The clay weathering is documented in core drillings from the area. During the weathering iron has been dissolved and precipitates in fractures as iron-oxides. In the core drillings it is also clear that there often is chlorite in the fractures (Wikman and Bergström 1987).

Method

Two core drilled boreholes and a percussion drilled borehole were logged in conjunction with the rock tunnel construction through the Hallandsås Horst (figure 1). The core drilled holes were first logged and data correlated with the cores. Thereby the logging result is calibrated and the experience can be used for the interpretation of logging records in the percussion drilled holes.

The cores from the core drillings were preserved and available for comparison with logging data even though the drillings were done in 2001 and 1998 respectively. Two core drilled boreholes (named KB5336 and KB6105), were investigated with the total core length of 370 m. Both boreholes were inclined 15 – 20 degrees from vertical and had a diameter of \varnothing 74 mm. During core sampling the rock cores were classified, i.e. rock type, joints and weathering. The weathering was classified using ISRM (1980).

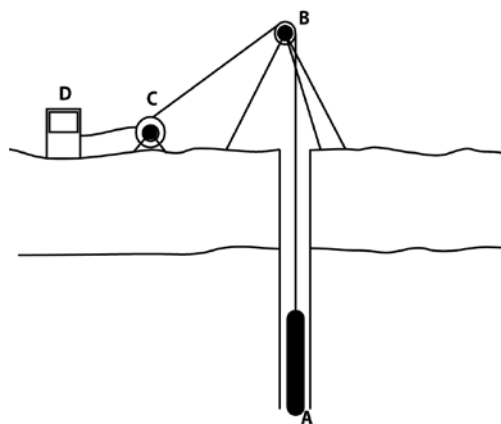

Figure 2. Schematic drawing of the logging setup. A is the logging probe, B is the tripod with a sheave, C is a cable winch and D is measuring unit. Modified from Takahashi et al. (2006).

The percussion drilled hole (named MK28) was drilled in 2004. The borehole is 106 m deep and has a diameter of \varnothing 165 mm. It should be noticed that a percussion drilled hole generally is more uneven in diameter than a core drilled hole. The lithology and weathering was described from the rock cuttings by a geologist at the site. The weathering of the rock cuttings was classified using ISRM (1980).

The logging equipment, from *Robertson Geologging Ltd*, and the setup used was natural gamma (on each probe as depth matching), caliper, long and short normal resistivity, temperature, self potential and single point resistance (the last three are not shown). A schematic drawing of the logging setup is seen in figure 2. The logging curves were plotted using the software *Strater* version 1.4.33 from *Golden Software*.

A time after the loggings had been carried out the original cores from KB5336 and KB6105 were placed on the ground in one succession and afterwards inspected visually. The first round of inspection was done to facilitate an impression of how the geology and structures changes through the core. The second inspection was done using the resistivity logs in order to identify if structures could be correlated with resistivity anomalies. The observations and details of the rock classification were documented by photographs.

The percussion drilled hole MK28 was logged with the same setup as the core drilled boreholes. The results were then evaluated using the experience and results from KB5336 and KB6105.

Logging probes

In the following a very brief presentation of the different logging probes is given. For more information the reader is referred to literature (e.g. Daniels and Keys 1990; Ellis and Singer 2007; Ernstson 2006; Howard 1990; ISRM 1981; Paillet and Ellefsen 2005; Rasmussen and Bai 1987; Schepers et al. 2001; Segesman 1980).

Natural gamma log

Natural gamma logging is a passive logging technique where the natural gamma-ray intensity of the formation along the borehole is measured. The gamma photons are mainly produced by decay of naturally occurring and unstable potassium (^{40}K), uranium (^{238}U) and thorium (^{232}Th). K-feldspars are highly radioactive because of the large content of potassium. On the other hand the amphiboles and quartz are not radioactive. Thus gneiss is more radioactive than amphibolites (Ernstson 2006; Nielson et al. 1990). The radioactivity is measured in count per second (cps). When presented it can also be in API units. This however requires a calibration against a known source.

Caliper log

The three-arm caliper measures variations in borehole diameter with depth. The diameter is determined by three mechanically coupled arms in contact with the borehole walls. The use of a caliper tool to locate fractures requires that the fractures be either open or sufficiently enlarged by drilling, e.g. clay weathered rock can be washed out, to permit a change in borehole diameter to be detected by the tip of the caliper arm (Howard 1990). The measurements are done when the tool is pulled up the borehole. The caliper probe is equipped with a gamma detector for depth matching. The borehole diameter is given in mm.

Long/Short Normal Resistivity log

The electric log is the oldest logging method and was first used in 1927 by the Schlumberger brothers and H. Doll (Ellis and Singer 2007). Resistivity is a measure of the ability with which electric current passes through a material. The resistivities in igneous and metamorphic rocks are extremely high when compared to resistivities in clay weathered, fractured and water bearing rock, figure 3. Therefore the resistivities in igneous and metamorphic rock can be lowered significantly by the presence of open fractures with water and clay weathered zones (Daniels and Keys 1990). Resistivity is measured in Ωm (ohm-meter).

There exists several different instrument setups but in this case the short and long normal resistivity log is used. The probe has a current and two potential electrodes with different intervals (16" (short) and 64" (long)). The distance between current and potential electrodes determines the depth of penetration. The larger distance the deeper into the formation can the current penetrate. The drawback with the larger penetration depth is that small zones are not detected. The probe is equipped with a gamma probe for depth matching.

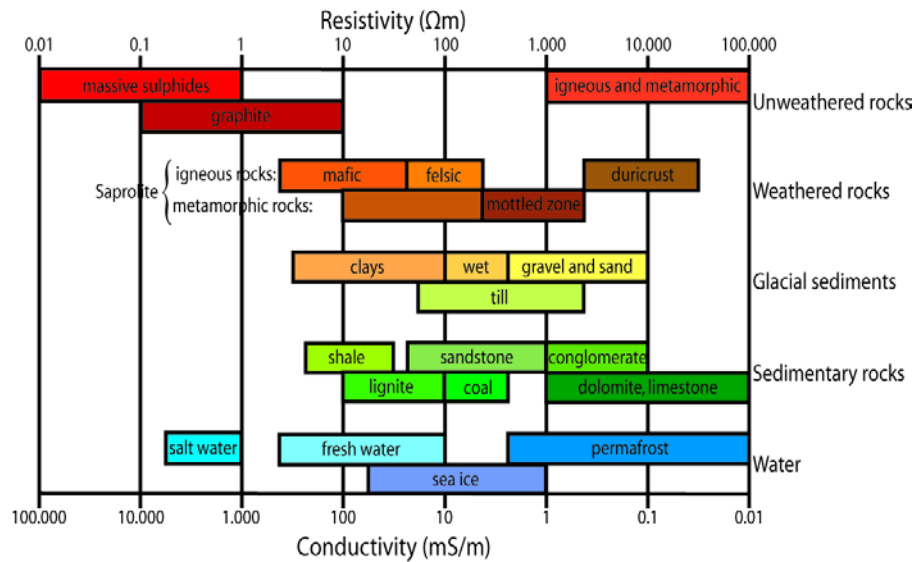

Figure 3. The resistivity of different materials. The resistivity is measured in Ωm . The reciprocal of resistivity is conductivity which is measured in mS/m . Modified from Palacky (1987).

Results

The geophysical logging data for borehole KB5336 and KB6105 is plotted together with the lithology log in figure 4 and 5 respectively. The geophysical logs are natural gamma, caliper and long/short normal resistivity log. In the column to the right the observations from the visual inspection of the cores is entered. Photographs document some of these observations (examples shown in figure 6).

In KB5336 (figure 4) the natural gamma log has lower counts in the amphibolite than in the gneiss. There are some narrow peaks with higher counts than 300 cps, e.g. at 66 m and 150 m. The caliper log had difficulties unfolding because of the inclined hole and consequently the fractures at 40 m, 120 m and 170 m appear exaggerated. Besides the mechanical problem with the probe the caliper shows several irregularities where the diameter of the borehole increases instantaneously. The intervals are coinciding with intervals where the short resistivity log has low resistivity. Examples are at 53 m, 80 m and 104 m where especially the short resistivity log has large excursions. The resistivity differs between 10 Ωm and 10 000 Ωm . In the first 120 m of the borehole the resistivity is mainly high (10 000 Ωm) but with narrow areas with low resistivity (1 000 Ωm). Below 134 m the short resistivity log changes character shifting intensively and is dominated by lower resistivity (<1 000 Ωm). The deeper penetrating long resistivity log does overall not have the same sensitivity and therefore the log is not as detailed as the short resistivity log. The visual observations show that the low resistivity intervals strongly coincide with fractures and/or joint sets. The fractures were often clay filled due to weathering. The high resistivity coincides with fresh rock with few or no fractures. The change in the resistivity log curve behaviour from 134 m (see figure 6A) is clearly due to higher fracture frequency.

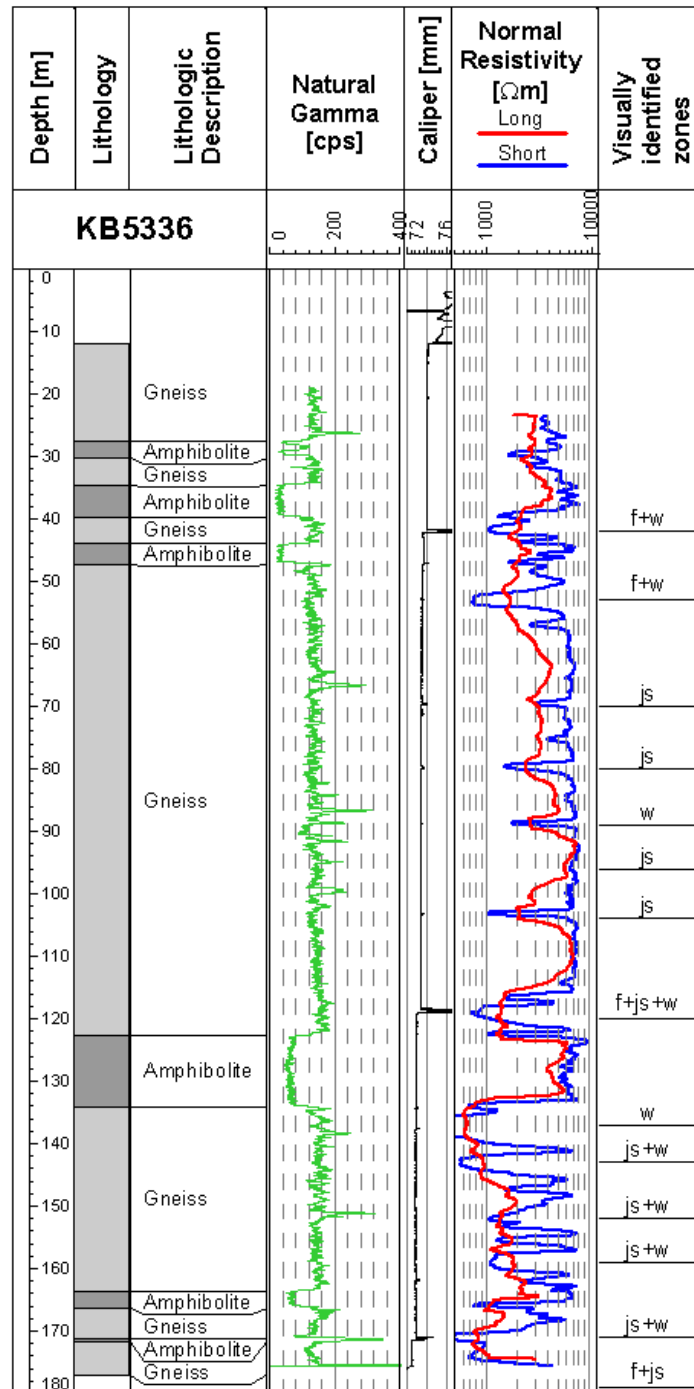

Figure 4. The log for KB5336. From left to right is the depth, lithology, natural gamma, caliper, normal resistivity and visually identified zones. The identified occurrences are abbreviated fracture (f), weathering (w), joint set (js).

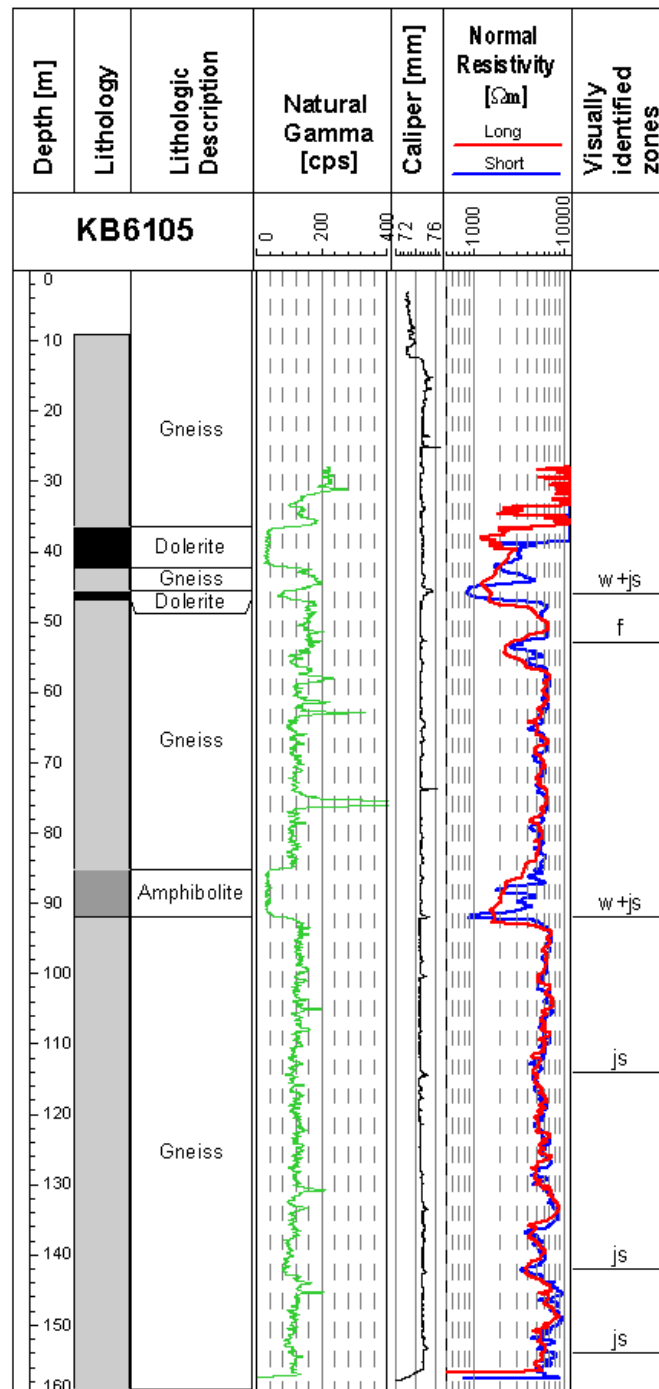

Figure 5. The log for KB6105. From left to right is the depth, lithology, natural gamma, caliper, normal resistivity and visually identified zones. The identified occurrences are abbreviated fracture (f), weathering (w), joint set (js).

The lithology log for KB6105, figure 5, shows that it consists mainly of gneiss with two thin layers of dolerite and one with amphibolite. The natural gamma log has high count in the gneiss whereas there is low count in both the dolerite and the amphibolite. At 77 m there is a peak with more than 400 cps with no obvious explanation. The caliper log has some small irregularities where the diameter for the borehole increases which cannot be explained, e.g. 46 m, 90 m and 118 m. The long and short resistivity log follows each other to a much larger degree than for KB5336. The difference between the highest and lowest resistivity is also smaller than in KB5336. Generally it can be seen

that the gneiss has a high resistivity ($\sim 5\,000\ \Omega\text{m}$) whereas the dolerite and the amphibolite have a low resistivity ($1\,000 - 2\,000\ \Omega\text{m}$). In this case the visual inspection showed that the gneiss was homogeneous and of a high quality with few fractures. The low resistivity at 46 m and 92 m coincide with fractures. On the other hand the low resistivity at 38 m and 88 m (see figure 6B) can not be correlated with fractures. Here the dolerite and amphibolite, respectively, was fresh without any fractures or weathering. The caliper log also showed a small increase in the borehole diameter where there were small variations in resistivity, e.g. at 144 m, which was identified as joint sets.

The photograph in figure 6A shows an example of fractures, joint sets and clay weathering in KB5336 at 135 m. In figure 6B the fresh amphibolite in KB6105 at 88 m is seen.

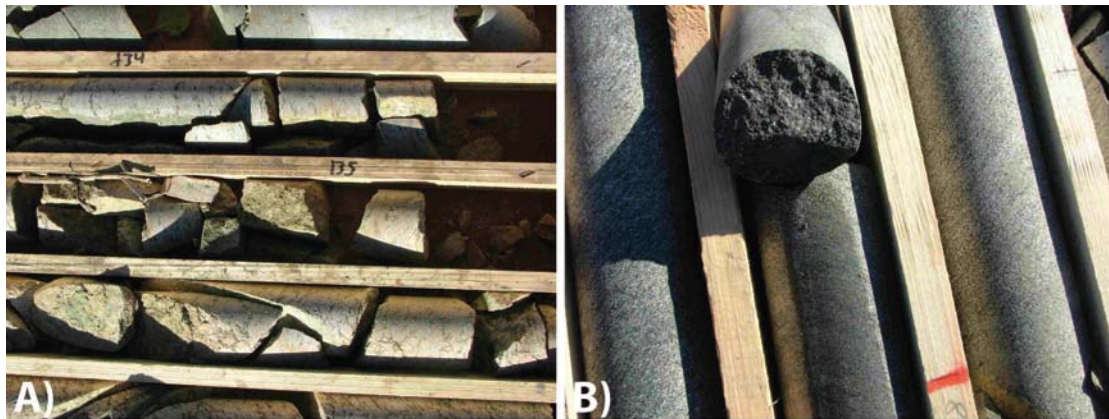

Figure 6. A) KB5336: highly weathered and fractured rock at 135 m. B) KB6105: fresh amphibolite at 88 m (the author broke the core in order to take a sample).

The results from the logging of MK28 are plotted in figure 7. The lithology to the left is the observations from drilling of the borehole. The driller or geologist at site made the interpretation based on the cutting samples which also included differentiating between different gneisses. Regular gneiss is classified as grey whereas some parts are grey-red (G/R) and some are quartz-rich (QR). Then there are also parts which contains aplite.

The natural gamma log primarily fluctuates between 160 and 200 cps. The most prominent anomaly is between 40 m and 42 m where there are less than 40 cps. Additionally two narrow anomalies at 47 m and 77 m have less than 40 cps. At 57 m and 88 m there are narrow peaks with 280 cps. Below 92 m the gamma log changes character and it mainly fluctuates between 120 and 160 cps. The caliper and resistivity logs are divided into six zones, A to F. The division is based on how the logs changes character. The interpreted occurrences are marked with *w* for weathering, *js* for joint sets and *f* for fractures. In zone A the caliper has very small variations around 168 mm. The 5 – 6 incidents where the diameter increases to more than 170 mm are interpreted as joint sets, fractures and weathering. This is also based on the fact that the resistivity decreases at these locations. This is especially noted at 28, 32 and 36 m. The resistivity is varying between 1 000 and 3 000 Ωm . Zone B is characterized by a larger variation in the caliper log ($\sim 165 - 175$ mm). In addition the resistivity is less than 1 000 Ωm . At 45 m there is a prominent peak in the caliper log as well as a low in the resistivity log. This is interpreted as joint sets and could also be weathering. In zone C the caliper has large variations. Between 56 and 62 m the caliper shows two zones with a diameter of 145 mm. In the first zone the resistivity is 3 000 Ωm whereas in the second zone the resistivity is 1 000 Ωm or less. This is followed by 6 m with very little variations where the resistivity is 3 000 Ωm . Between 68 and 70 m the

diameter is close to 180 mm. This is coinciding with a resistivity of 500 Ωm . Zone *D* is 7 m thick with large variations in the caliper log ($\sim 150 - 175$ mm) and low resistivity (~ 400 Ωm). This is interpreted as joint sets and weathering and a change in lithology. In zone *E* the resistivity increases to 1 500 Ωm but still there are large variations in the caliper log. In zone *F* the caliper log has very few variations and the resistivity is 6 000 – 7 000 Ωm .

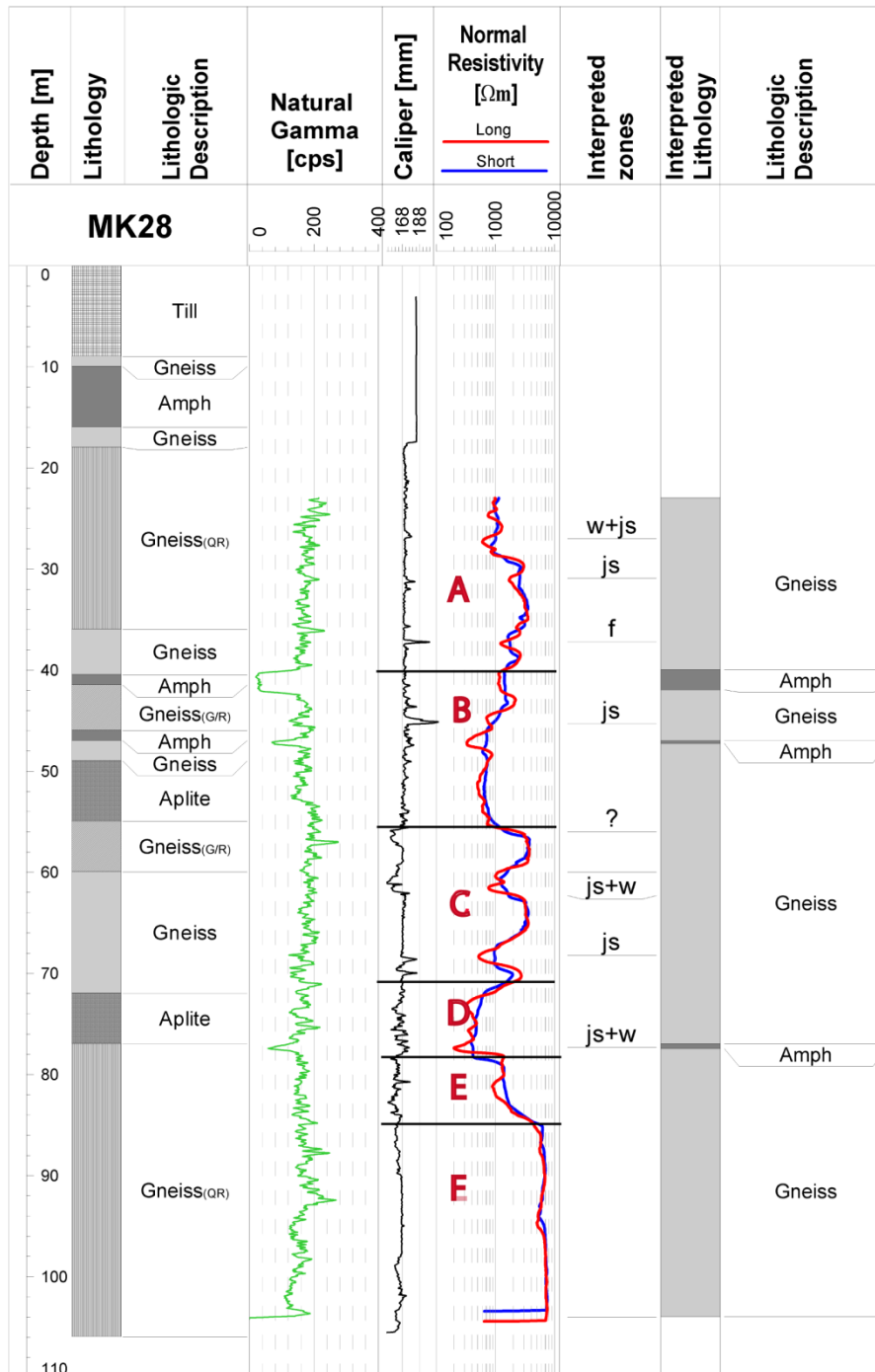

Figure 7. The geophysical log and interpretation of the percussion drilled borehole MK28. The lithology to the left is the observations from the drilling of the borehole. The lithology to the right is an interpretation based on the gamma log. The interpreted occurrences are based on the caliper and the resistivity log and are abbreviated fracture (*f*), weathering (*w*), and joint set (*js*). Additionally the caliper and the resistivity log are divided into six zones, A to F, based on their different characteristic.

Discussion

The visual inspection, illustrated by the photographs in figure 6, shows clearly that fractures, joint sets, weathering and in some cases even lithology change can be identified by geophysical logs in crystalline rock. With the experience from the core drilling in mind the interpretation of the logging result from MK28 becomes more detailed and less uncertain.

The logging of KB5335 shows clearly that the gamma log detects changes in lithology from gneiss to amphibolites. The gneiss contains potassium rich minerals as K-feldspar and biotite and thus the gamma log has a higher count in these parts. The caliper log detects fractures and joint sets even though it has difficulties in unfolding in the inclined hole. A high resistivity without any excursions is the result of rock mass with few fractures and no weathering. Where the resistivity is lower the rock mass is fractured and weathered. Below a depth of 135 m the resistivity log has more excursions due to the introduction of a second fracture direction seen by visual inspection. The depth is especially interesting for the tunnel project because it occurs at tunnel level. Even though the resistivity log does not give a direct measure of the rock properties it is still possible to get information about how fractured and weathered the rock is.

The logging result from KB6105 shows a more homogeneous rock mass than KB5336. Also here the gneiss has a high count in the gamma log due to the high content of radioactive K-feldspars and biotite. It is not possible for the gamma log to distinguish between dolerite and amphibolites due to the similar mineral content. A high peak is seen at 77 m which can not be explained by looking at the core. It is not considered to be an artifact because it covers several measuring points. The caliper log does not have the same difficulties in unfolding in this borehole as in KB5336. More fractures and joint sets are detected by the caliper log in this borehole. The resistivity log is generally more even than in KB5336. The resistivity in the amphibolites/dolerites is lower than in KB5336 which the visual inspection did not explain. The reason for the difference in resistivity is probably due to initial weathering of pyroxene and is discussed in Danielsen and Madsen (2010). The resistivity in the gneiss shows only small excursions. Below 130 m the resistivity log seems to change character which coincides with the same depth as where the second fracture direction is introduced in KB5336.

From the logging data in the core drilled boreholes the obtained experience can be used when interpreting the logging results in the percussion drilled borehole. All three boreholes are situated within 3 km of each other and even though the geology varies in the area it is reasonable to assume that the results are comparable. The different sonds respond to different physical properties and in this case the three types of geophysical sonds have the following characteristics:

Natural gamma: Low count when the lithology is amphibolite or dolerite and high count when the lithology is gneiss. This is regardless of fractures. It is however not possible to distinguish between amphibolite and dolerite, because mineralogically they are similar however with different texture.

Caliper: Increased diameter over a short interval indicates fractured rock mass and the wider peaks are joint sets and weathered zones.

Normal resistivity: Low resistivity (800 – 2 000 Ωm) indicates where the rock is fractured and/or weathered. A high resistivity (>6 000 Ωm) shows homogeneous rock.

The properties of the rock mass which the different geophysical logs detect in the specific geological environment are summarized in table 1. With this in mind the logging result of the percussion drilled borehole MK28 can be interpreted with higher grade of certainty.

Table 1. Properties the gamma log, caliper log and resistivity log detects are summarized and marked with X.

	Lithology Change	Joints	Fractures	Weathering
Gamma	X			
Caliper		X	(X)	X
Resistivity	X	X	X	X

The lithology description made at the MK28 drill site is relatively detailed and is based on the drill cuttings (< 2x2 cm). This demands a very skilled geologist at the site. If that is not the case there might be some uncertainties in the determination of the lithology and the position of the different lithology contacts. An advantage with borehole logging is that it provide continuous in situ measurements and that the data is recorded, so that any ambiguity in the result it can be viewed by more than one person. In MK28 some inconsistencies exist between the depth and presence of amphibolites/dolerite. Because logging is in situ measurements the gamma log gives a precise position and thickness of the amphibolites/dolerites. Here it is obvious that the discrepancy is due to the difficulties by determining the correct depth from cutting samples (related to the delay time for the cuttings to come to surface).

Due to the percussion drilling method used in MK28 the caliper log has much larger variations than the core drilled boreholes. Some of the detected fractures and irregularities can therefore have been introduced by the drilling method. Combined with the resistivity log it becomes more certain to pinpoint fractures and weathered zones. The parts where the caliper log shows a larger borehole diameter and simultaneously the resistivity is lower there is probably a fractured/weathered zone. In the upper part of zone C there are some question marks regarding two 4 m thick zones, where the caliper log has a decreasing borehole diameter and the resistivity is high in the upper zone and low in the lower zone. It is expected that when the borehole diameter is small the rock mass quality is good and as a consequence the resistivity is high. This is also the case at 57 m however at 60 m the resistivity is low and the borehole diameter is decreased which is the opposite of what is anticipated. A possible explanation might be stress related so that the borehole diameter decreases.

The division of zones in MK28 helps characterizing the rock mass, so that each zone has a different character. It can be expected that the rock formation has different mechanical properties in the six zones. The properties in the different zones are summarized in table 2.

The logging probes used in the three boreholes are common standard and part of most logging equipments. They provide useful information but additional logging probes could with benefit be used to give more information. An example is the sonic log which involves high frequency P-waves or acoustic waves to obtain a detailed velocity profile along the borehole. The velocities of P- and S-waves if recorded can be used to calculate dynamic modulus of elasticity (Takahashi et al. 2006). Another logging probe which could be used with great advantage is the optical televiewer. The optical televiewer provides a continuous and oriented image of the borehole wall. This gives

information about fractures, fracture orientation, dip and strike as well as a visual image of the rock surrounding the borehole (Paillet and Ellefsen 2005).

Table 2. The characteristics of the six different zones A-F in MK28.

Zone	Characteristic
A	Few fractures
B	Several lithology contacts – might contain water
C	Changing rock quality
D	Very fractured + weathered – lithology change
E	Fractured + weathered
F	No fractures

The information obtained from borehole geophysics can be useful in pre-investigations for a rock tunnel construction. Borehole geophysics is small scale and detailed information which therefore should be performed in the final stages of the pre-investigation. A pre-investigation should be performed top down, meaning that the investigations should start on large scale and continue into more and more details. By starting with large scale geophysics it is possible to position the boreholes in a more cost efficient way, so that as much information is gained as possible. The borehole and the borehole geophysics can be useful for the interpretation and calibration of the surface based geophysics. The pre-investigation should be seen as a dynamic process where it is important after each step to make a preliminary interpretation of all information. Through the entire project it is also important to keep in mind what the different investigations contributed with. New information shall part by part be used for updating or correcting the actual conceptual geological understanding. When as much information as possible is gathered an interdisciplinary interpretation should be made and based on this the engineering geological prognosis is done.

An important issue in all construction projects is cost. Therefore it is of major significance that a core drilled borehole is 4–5 times as expensive as a percussion drilled borehole (Swedish prices 2010, excl. mobilization/demobilization, L. Bjelm (personal communication, 2010)). A percussion drilled borehole including logging with the probes used here is approximately one third of the price of a core drilled borehole. Thus the results encourage to perform logging in the cheaper percussion drilled boreholes. In this way there can be obtained a high amount of details and still keeping the costs down.

Another important issue with borehole geophysics is that the data are recorded and should therefore be archived and re-interpreted if necessary. Cores from a core drilling shall be preserved in a project, but the moisture has disappeared and new fractures might have been added. Samples of rock cuttings from percussion drilled holes can also be preserved, and they will only be sporadic samples not providing a full impression of the variations in the borehole. The borehole geophysical data will on the other hand always show the conditions in the borehole when the data was recorded.

Conclusion

When comparing the cores with the response from the different geophysical probes the correlation and the great number of details revealed are remarkable. The different geophysical probes detect different physical properties. Fractures and weathered zones are evident in the resistivity logs and in the caliper log, whereas lithology changes are visible in gamma log and to some extent in the resistivity log. A combination of several logs is the optimal solution. By combining the caliper and the resistivity log an impression of the degree of fracturing is achieved. The probes used in this case are basic and part of most logging equipments. Several other probes could with advantage be used, e.g. optical televiewer and sonic log.

A large advantage with geophysical logging is that the measurements are continuous and in situ. Thus without full core recovery in a core drilling the geophysical logging will give information about the bedrock in the difficult parts. Another advantage is that the data are recorded and archived. The data can then be re-interpreted if that becomes necessary.

The results show the value of geophysical borehole logging in crystalline bedrock. Borehole geophysics should be a natural part of pre-investigation for rock tunnel construction and other rock mass construction projects. The logging results provides detailed information about the rock mass properties which directly can be used for the engineering geological prognosis but also for calibration of the interpretation of the large scale surface based geophysics.

The results also demonstrate that logging in non-cored boreholes, e.g. percussion drilled boreholes, reveal useful information especially when there are a few cored drill holes in the vicinity to associate with. Even without access to core drilled boreholes logging in non-cored boreholes is useful when a general knowledge of the geological setting is available.

References

- Dahlin, T., Bjelm, L., and Svensson, C. 1999. Use of electrical imaging in site investigations for a railway tunnel through the Hallandsås Horst, Sweden. *Quarterly Journal of Engineering Geology*, **32**: 163-172.
- Daniels, J. J. and Keys, W. S. 1990. Geophysical Well Logging For Evaluating Hazardous Waste Sites. *In Geotechnical and Environmental Geophysics, Vol 1, Review and Tutorial. Edited by S.H. Ward, Society of Exploration Geophysicists.*
- Danielsen, B.E. and Madsen, H.B. 2010. Difference in Resistivity Explained by Initial Stage of Weathering. Accepted as conference proceeding. 16th European Meeting of Environmental and Engineering Geophysics, Zurich, Switzerland.
- de Lima, O. A. L. and Niwas, S. 2000. Estimation of hydraulic parameters of shaly sandstone aquifers from geoelectrical measurements. *Journal of Hydrology*, **235**(1): 12-26.
- Ellis, D. V. and Singer, J. M. 2007. *Well Logging for Earth Scientists*. Springer.
- Ernstson, K. 2006. Magnetic, geothermal, and radioactivity methods. *In Groundwater Geophysics - A tool for hydrogeology. Edited by R. Kirsch. Springer.*
- Graversen, O. 2009. Structural analysis of superposed fault systems of the Bornholm horst block, Tornquist Zone, Denmark. *Bulletin of the Geological Society of Denmark*, **57**: 25-49.

- Howard, K. W. F. 1990. Geophysical Well Logging Methods for the Detection and Characterization of Fractures in Hard Rock. *In Geotechnical and Environmental Geophysics, Vol. 1, Review and Tutorial. Edited by S.H. Ward, Society of Exploration Geophysicists.*
- ISRM 1980. Rock characterization, testing and monitoring, ISRM suggested methods. *Edited by E.T. Brown, Pergamon Press.*
- ISRM 1981. Suggested methods for geophysical logging of boreholes. *International Journal of Rock Mechanics and Mining Sciences and Geomechanics Abstracts, 18(1): 67-84.*
- Lantmäteriverket, 2001, GSD - Terrängkartan (Map):513.
- Liboriussen, J., Ashton, P., and Tygesen, T. 1987. The tectonic evolution of the Fennoscandian Border Zone in Denmark: Tectonophysics, **137**: 21-29.
- Nielson, D. L., Linpei, C., and Ward, S. H. 1990. Gamma-Ray Spectrometry and Radon Emanometry in Environmental Geophysics. *In Geotechnical and Environmental Geophysics, Vol. 1, Review and Tutorial. Edited by S.H. Ward, Society of Exploration Geophysicists.*
- Paillet, F. L. and Ellefsen, K. J. 2005. Downhole Application of Geophysics. *In Near-Surface Geophysics. Edited by D. K. Butler, Society of Exploration Geophysicists.*
- Palacky, G. J. 1987. Resistivity Characteristics of Geologic Targets. *In Electromagnetic methods in applied geophysics. Edited by M. N. Nabighian, Society of Exploration Geophysics.*
- Rafat, G., Lehmann, B., Toumani, A., and Rueter, H. 2001. Characterisation of rock ahead and around tunnels and boreholes by use of geophysical and geological methods. *International Journal of Rock Mechanics and Mining Sciences, 38(6): 903-908. doi: 10.1016/S1365-1609(01)00056-9*
- Rasmussen, K. R. and Bai, W. 1987. Logging in deep water wells in central Jutland, Denmark. *Boreas, 16(4): 393-404. doi: 10.1111/j.1502-3885.1987.tb00112.x*
- Schepers, R., Rafat, G., Gelbke, C., and Lehmann, B. 2001. Application of borehole logging, core imaging and tomography to geotechnical exploration. *International Journal of Rock Mechanics and Mining Sciences, 38(6): 867-876.*
- Segesman, F. F. 1980. Well-logging method. *Geophysics, 45(11): 1667-1684. doi: http://dx.doi.org/10.1190/1.1441057*
- Swedish Geological Survey. 1981. SGU Ser. Af nr 133 Flygmagnetiska Kartan 4C Halmstad SV.
- Takahashi, T., Takeuchi, T., and Sassa, K. 2006. ISRM Suggested Methods for borehole geophysics in rock engineering. *International Journal of Rock Mechanics & Mining Sciences, 43(3): 337-369.*
- Wikman, H. and Bergström, J. 1987. Beskrivning till Berggrundskartan Halmstad SV Swedish Geological Survey, Uppsala.

Paper 4 Danielsen, B.E. and Madsen, H.B. (2010)

**Geophysical logging as a tool for identifying initial weathering in
crystalline rocks.**

Submitted for publication to *Near Surface Geophysics*

Geophysical logging as a tool for identifying initial weathering in crystalline rocks

Berit Ensted Danielsen¹ and Heine Buus Madsen²

¹Engineering Geology, Lund University, John Ericssons väg 1, S-223 63 Lund, Sweden

²Senenergy, Rosenberggatan 99, N-4004 Stavanger, Norway

Abstract: Geophysical logging is a useful tool in rock engineering projects where it gives valuable and detailed information. Unfortunately it is often neglected because of the additional cost of such an operation. However, experience show that geophysical logging can be used with advantage, supplying a high information level of the geology and thus saves money in the end. The scope of this paper is to show how even low degrees of weathering of rocks affects the geophysical log respond, by means of thin section microscopy, point counting and logging. This was done on gneisses and amphibolites from two drill cores done in connection with the construction of the Hallandsås Tunnel, Southern Sweden. The resistivity logs can thus detect even low grades of weathering of amphibolites which can be important for the mechanical properties of the rock.

Keywords: geophysical logging, resistivity, microscopy, weathering, pre-investigation

Introduction

Geophysical logging is a useful tool in rock engineering projects where it gives valuable and detailed information. Unfortunately it is often neglected because of the additional cost of such an operation. However, experience show that geophysical logging can be used with advantage, supplying a high information level of the geology and thus saves money in the end.

On behalf of the International Society of Rock Mechanics (ISRM) Takahashi *et al.* (2006) gives guidelines for how to use borehole geophysics to obtain useful and valuable outputs for rock engineering projects. Rafat *et al.* (2001) and Schepers *et al.* (2001) give examples on how borehole geophysics can contribute with information about lithology, structural and rock mechanic information. ISRM (1981) suggests geophysical logging of boreholes in order to determine the geometry of major subsurface structural discontinuities. The detailed information from geophysical logging is very important in the calibration of the interpretation of large scale geophysics, e.g. geoelectrical measurements. Dahlin *et al.* (1999) use geophysical borehole logging for calibration, reference and verification of the surface geoelectrical data. An advantage with borehole geophysics is that where there is not full core recovery the geophysical log will also give information from the missing parts. Additionally data are continuous and are recorded so that they give information about the site conditions when measured.

Even though the logging of a core drilled hole gives many answers, there are however, unanswered questions and it can become necessary to go into even more details to get a clear answer. For example, the use of optical televiewer, core logging and microscopy of rocks taken from drill cores can improve the interpretation of the geophysical logs and gives more detailed information of the geology, as fractures and weathering, which is crucial in large engineering projects.

For instance, the construction of Hallandsås Tunnel, Southern Sweden, has been problematic with delays and raised budget as a consequence. A major problem has been large differences in the mechanical properties of the rock. A deep weathering of the rock has in some parts resulted in zones in the bedrock where the mechanical properties are as clay's. In other parts of the rock fractures contains water under a high pressure. Even though borehole geophysics can be a valuable tool, only a few boreholes at the Hallandsås Tunnel are surveyed with geophysical logging (Dahlin *et al.*, 1999).

The scope of this paper is to show how even low degrees of weathering of rocks affects the geophysical log respond, by means of thin section microscopy, point counting and logging. This was done on gneisses and amphibolites from two drill cores done in connection with the construction of the Hallandsås Tunnel, Southern Sweden.

Geological setting

The Hallandsås Horst is located in Southern Sweden (Fig. 1), and is the result of a tectonic activity, which has been going on since Silurian time. The uplifted blocks have a NW-SE orientation and occur in the Tornquist Zone. This tectonic element stretches all the way to the Black Sea (Wikman and Bergström, 1987). The Hallandsås Horst is 8 – 10 km wide, 60 – 80 km long and reaches an elevation of 150 to 200 meters in the tunnel area (Dahlin *et al.*, 1999).

The Hallandsås ridge is mainly build up by Precambrian crystalline rock of both intrusive and sedimentary origin. Amphibolites of several generations also occur where the oldest often are seen as minor layers or schlieren parallel to the layering in the gneisses. The younger amphibolites have distinct contacts and cross cuts older structures. These younger dykes are commonly oriented in a NNE-SSW direction. In addition, sedimentary rocks of Phanerozoic ages cover minor areas (Wikman and Bergström, 1987).

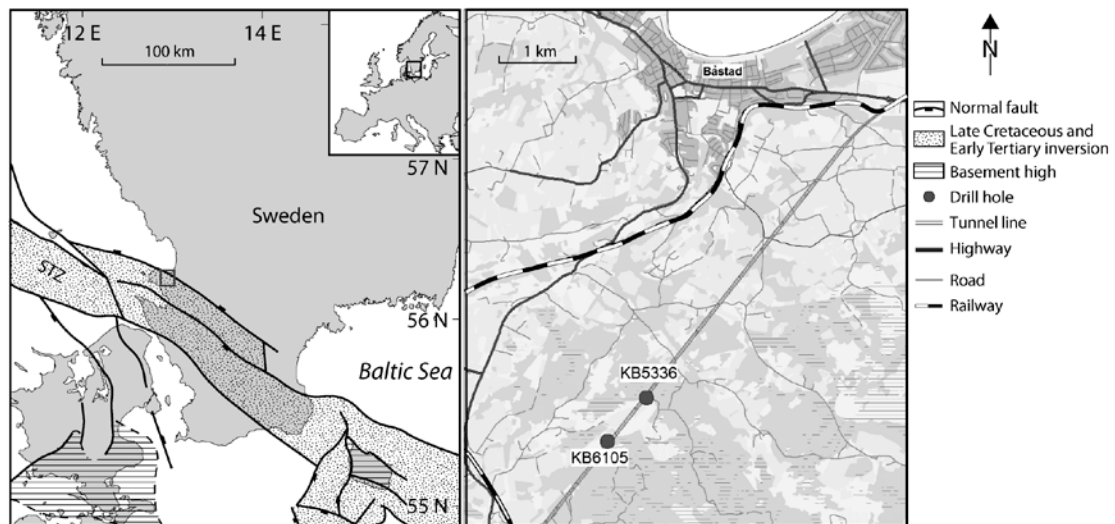

Figure 1. Left: Map of Southern Sweden showing the position of the investigation area and the outline of the Tornquist Zone (STZ). Right: The position of the two logged boreholes along the tunnel line 770 meters apart. The core drilled holes are KB5336 and KB6105. Maps are modified from Graversen (2009), Lantmäteriverket (2001) and Liboriussen *et al.* (1987).

The bedrock is also intruded by a set of younger Permian dolerite dykes with their trend parallel to the Scanian horsts (Wikman and Bergström, 1987). These dolerite dykes are seen as very distinct linear positive anomalies on the aeromagnetic map (Swedish Geological Survey, 1981). On the

aeromagnetic maps it is even possible to see a NNE-SSW and NE-SW oriented fracture systems because they disconnect the positive anomalies associated with the dolerite dykes.

The dominant fracture system is oriented in NW-SE direction corresponding to the Tornquist Zone. Another distinct fracture system has a NNE-SSW direction and is younger than the NW-system (Wikman and Bergström, 1987).

Substantial deep weathering of the bedrock began during Triassic and continued periodically during the Cretaceous and to present day. This resulted in a weathering of the feldspars in the gneisses to mainly kaolinite. The weathering is documented in drill cores from the area (Wikman and Bergström, 1987).

Methods

In conjunction with the rock tunnel construction through the Hallandsås Horst, Southern Sweden, around 30 core holes were drilled. Two of the core drilled boreholes and corresponding cores were available for comparison with logging data. The cores from the core drillings KB6105 and KB5336 were preserved even though the drillings were done in 2001 and 1998 respectively. The boreholes are located 770 m apart (Fig. 1). The two core drilled boreholes, with a diameter of 74 mm and a total core length of 370 m were investigated. Both boreholes were inclined 15–20 degree from vertical. During the drilling the rock cores were classified, i.e. rock type, joints and weathering. The weathering was classified using (ISRM, 1980).

The logging equipment is from *Robertson Geologging Ltd* and the setup used was natural gamma (on each probe as depth reference), caliper, long and short normal resistivity and temperature (not shown).

Geophysical logging

In the following a very brief presentation of the different logging probes is given. For more adequate information the reader is referred to literature (e.g. Daniels and Keys 1990; Ellis and Singer 2007; Ernstson 2006; Howard 1990; ISRM 1981; Paillet and Ellefsen 2005; Rasmussen and Bai 1987; Schepers *et al.* 2001; Segesman 1980).

Natural gamma log

Natural gamma logging is a passive logging technique where the natural gamma-ray intensity of the formation along the borehole is measured. The gamma photons are mainly produced by decay of naturally occurring potassium (^{40}K), uranium (^{238}U) and thorium (^{232}Th) (Ernstson 2006; Nielson *et al.* 1990). The radioactivity is measured in count per second (cps).

Caliper log

The three-arm caliper measures variations in borehole diameter with depth. The diameter is determined by three mechanically coupled arms in contact with the borehole walls. The use of a caliper tool to locate fractures requires that the fractures be either open or sufficiently enlarged by drilling, e.g. clay weathered rock can be washed out, to permit a change in borehole diameter to be detected by the tip of the caliper arm (Howard 1990). The measurements are done when the tool is pulled up of the borehole. The caliper probe is equipped with a gamma detector for depth matching. The borehole diameter is given in mm.

Long/Short Normal Resistivity log

Resistivity is a measure of the ability with which electric current passes through a material. The resistivity is reciprocal to the conductivity. The resistivities in igneous and metamorphic rocks are extremely high when compared to resistivities in clay weathered, fractured and water bearing rock. Therefore the resistivities in igneous and metamorphic rock can be lowered significantly by the

presence of open fractures with water and clay weathered zones (Daniels and Keys 1990). Resistivity is measured in Ωm (ohm-meter).

There exists several different instrument setups but in this case the short and long normal resistivity log is used. The probe has a current and two potential electrodes with different intervals (16" (short) and 64" (long)). The distance between current and potential electrodes determines the depth of penetration. A large distance between electrodes causes the current to penetrate deeper into the formation (Daniels and Keys 1990). The long resistivity log does not have the same sensitivity and therefore the log is not as detailed as the short resistivity log. Thus the drawback with the larger penetration depth is that small zones are not detected. The probe is equipped with a gamma probe as depth matching.

Visual inspection of cores

The original cores were placed on the ground in one succession and afterwards inspected visually. The first round of inspection was done to facilitate an impression of how the geology and structures changes through the core. The second inspection was done using the resistivity logs in order to identify the structures causing the resistivity anomalies. The core observations and details in the rock classification were documented by photographs, (Figs. 2 and 5). Finally, representative samples of the different rock types and rocks with unexplained resistivity anomalies were taken for thin sections.

It was decided to take 3 samples in the amphibolite from KB5336 and 2 samples in the amphibolite from KB6105 so as to have enough representative samples for thin sections. In KB5336 the samples were taken at 123.92–124 m (sample 1), 126.73–126.81 m (sample 2) and 133–133.06 m (sample 3). In KB6105 the samples were taken at 86.73–86.78 m (sample 4) and 91.57–91.61 m (sample 5). Additionally, one gneiss sample was taken from each core. In KB5336 the sample was taken at 109.55–109.57 (sample 6) and in KB6105 the sample was taken at 61.97–62.03 (sample 7).

Microscopy of thin section

The geophysical logging is calibrated with thin section microscopy and point counting to evaluate the weathering stage and to quantify the mineral content. The point counting was done on thin sections, 19 mm wide and 37 mm long, by using a point counter and registering the mineral phase for every 0.7 mm in both x and y directions. This summed up to approximately 1200 observations in each thin section. The accuracy on the point counting ranges from 1 to 3% depending on how common the mineral is. For documentation microphotographs of the thin sections were done at 2.5 times magnification.

Results

The lithology log for KB5336 shows that it consists mainly of gneisses with several amphibolite layers (Fig. 2). Three amphibolite layers, 3–5 meters thick, occur at 30–45 meters depth, one 11 m thick amphibolite layer occur at 130 m depth and two minor amphibolites, 3 and 0.5 meters thick, occur at the bottom of the core at 170 meters depth.

In KB5336 the natural gamma log has lower counts in the amphibolite than in the gneisses where the amphibolites have less than 40 cps and the gneisses have counts between 120 and 160 cps (Fig. 2). The caliper shows several irregularities where the diameter of the borehole increases in short intervals. These intervals are coinciding with intervals of low resistivity at 53 meters, 80 meters and 104 meters depth. The short resistivity log from KB5336 shows large fluctuations where the resistivity differs between 10 Ωm and 10.000 Ωm . In the upper 120 meter of the borehole the resistivity is mainly high (10.000 Ωm) but with narrow intervals with low resistivity (1000 Ωm). Below

120 meter the short resistivity log changes character and is dominated by low resistivity (< 1000 Ωm). The long resistivity log shows an average of the resistivity compared to the short log.

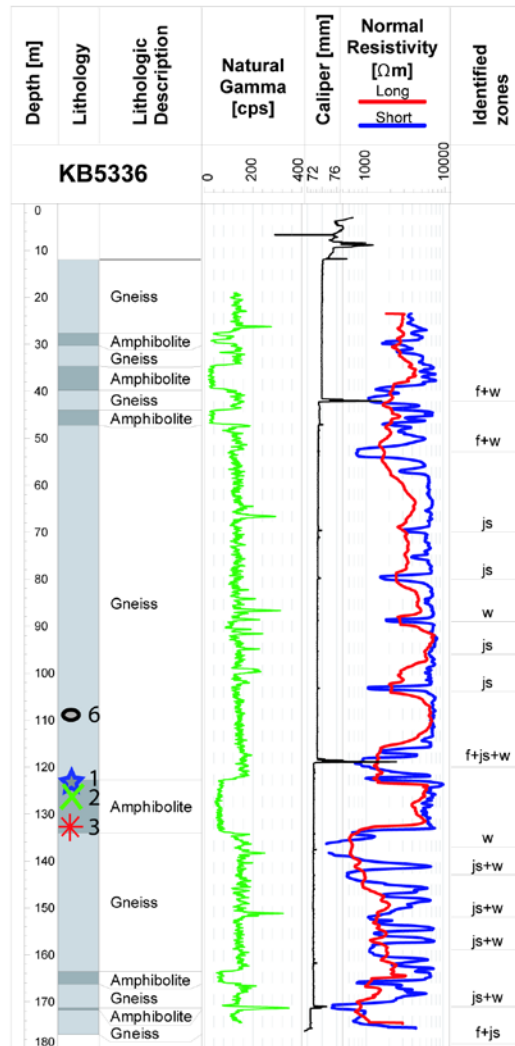

Figure 2. Lithology, natural gamma log, caliper and long/short resistivity log for KB5336. Zones identified by the visual inspection are marked with f (fracture), js (joint sets) and w (weathering). Markers in the depth scale shows where the samples for thin sections were taken (for the amphibolites the same markers are used in the mineral composition plot in figure 6).

The visual observations showed that the low resistivity intervals were coinciding with weathering, fractures and/or joint sets that occasionally were clay filled (Fig. 3). The high resistivity corresponds with intervals with fresh rock, both gneisses and amphibolites, without any fractures (Fig. 5). Below 120 meter a second joint set with another direction occur which is coincident with large and frequent excursions in the short resistivity log.

The lithology log for KB6105 shows that it also consists mainly of gneisses, with two dolerite layers at around 40 meters depth, 6 and 1 meter thick respectively, and one 7 meters thick amphibolite layer at 90 meters depth (Fig. 4).



Figure 3. Weathered gneiss at 173 meter in KB5336.

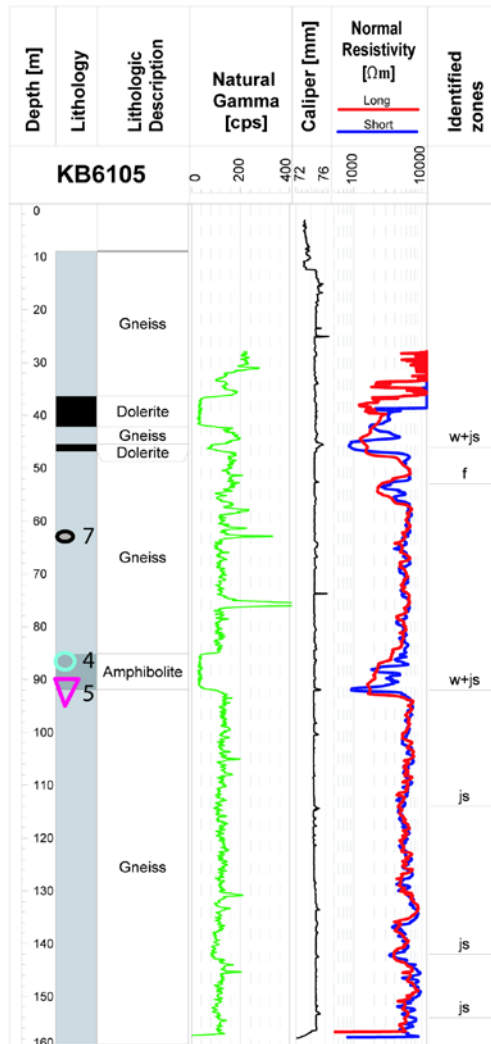

Figure 4. Lithology, natural gamma log, caliper and long/short resistivity log for KB6105. Zones identified by the visual inspection are marked with f (fracture), js (joint sets) and w (weathering). Markers in the depth scale shows where the samples for thin sections were taken (for the amphibolites the same markers are used in the mineral composition plot in figure 6).

The natural gamma log shows high counts (between 120 and 140 cps) in the gneiss whereas counts are low (< 40 cps) in both the dolerites and the amphibolite. Additionally there are several peaks with more than 140 cps. Especially at 76 meters depth a peak with more than 400 cps is present. During the inspection no explanation for this anomaly was found. The caliper log shows an increased diameter and wider peaks in limited intervals. At 46 meters depth at the transition between gneiss and dolerite the gamma log shows low count (70 cps), the caliper has a broad peak where the borehole diameter increases and the short resistivity log shows a resistivity of 800 Ωm which is coincident with joint sets and weathering. The long and short resistivity logs in KB6105 do not differ as much as in KB5336. Generally the gneiss has a high resistivity ($\sim 5000 \Omega\text{m}$) whereas the dolerite and the amphibolite have a low resistivity (1000–2000 Ωm) compared to those in KB5336.

For KB6105 the visual inspection showed that the gneiss was of a high quality with few fractures. The low resistivity at 92 meters coincided with fractures. The low resistivity at 38 meters and 88 meters on the other hand do not coincide with fractures. In these cases the dolerite and amphibolite were fresh without any fractures or weathering. The minor excursions in the resistivity log at e.g. 144 meters are identified as joint sets. The caliper log also shows a minor increase in the borehole diameter.

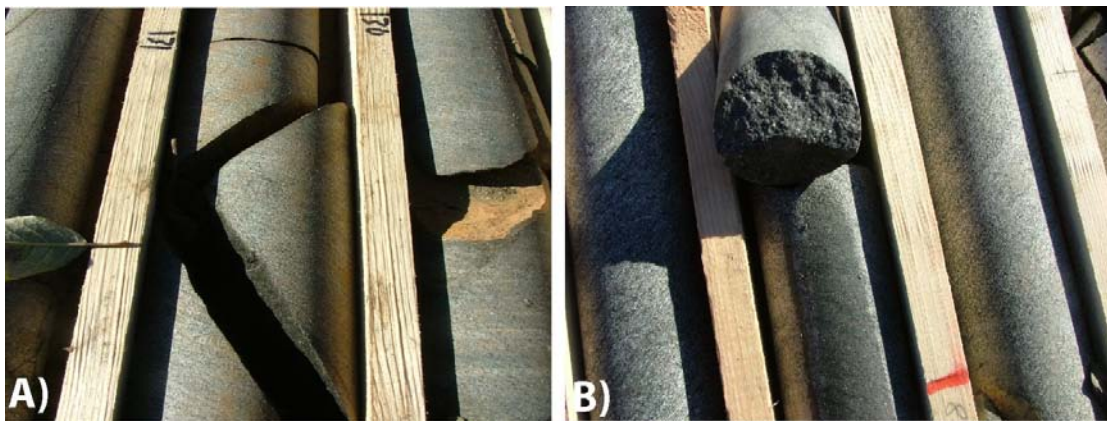

Figure 5. A) Unweathered amphibolites with joints at 130 metres depth in KB5336. B) Apparently unweathered amphibolites with no joints from KB6105 at 88 metre.

The resistivities of the amphibolites in KB5336 (Fig. 5a) are around 7000 Ωm whereas the resistivity of the amphibolite and dolerites in KB6105 (Fig. 5b) are around 2000 Ωm . Further the resistivity is constant within amphibolite layers in KB5336 whereas it fluctuates in the amphibolite and dolerite layers in KB6105. No obvious and visual explanations were found during the inspection of the core, thus samples were taken for petrographic investigations.

The initial petrographic investigation indicated that all the amphibolites are mainly comprised by plagioclase, amphiboles, pyroxenes, garnet with accessory quartz, biotite and an opaque phase probably low resistive oxides or sulphides (Fig. 7). However, the point counting show very little variance in mineral content (Fig. 6, Appendix A). Plagioclase is the most abundant mineral with a content of 35–40%. Hornblende is present with 25–30%. The only exception is for sample 2 (KB5336) which only contains 20% hornblende. On the other hand this sample contains 19% pyroxene which is 3–4% more than in the other samples. The samples contains between 8 and 10% garnet. The variation in the quartz contents is relatively large (3–8%) whereas the content of biotite is less than 3%. There are approximately 5% of the unspecified opaque minerals. Less than 1% of the mineral content is unidentified. The point count of the mineral content in the gneisses showed that they contained 15 and 17% alkalifeltspar whereas the amphibolites did not contain any (Appendix A).

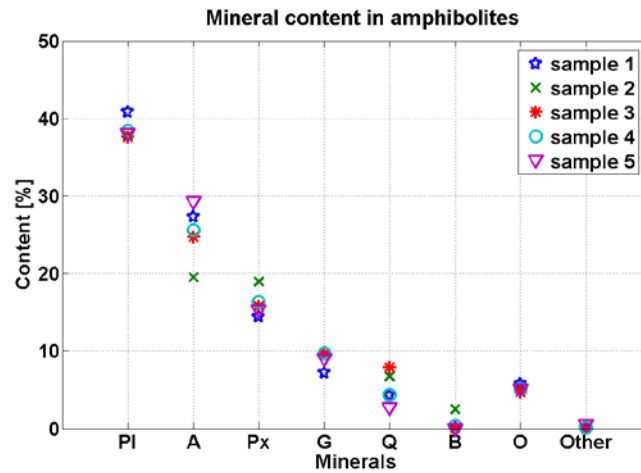

Figure 6. The mineral content [%] in the amphibolites. The minerals are abbreviated as follows: plagioclase (PI), hornblende (A), pyroxene (Px), garnet (G), quartz (Q), biotite (B), opaque (O) and other minerals (Other).

The microscopy of the thin sections showed microfractures in sample 1, 3 and 5. The fractures were filled with probably ironhydroxides or chlorite. Opaque minerals occur as isolated crystals (Fig. 7). In sample 4 and 5 several of the pyroxenes appears to be altered (Fig. 7b) compared to the pyroxenes in sample 1, 2 and 3 (Fig. 7a).

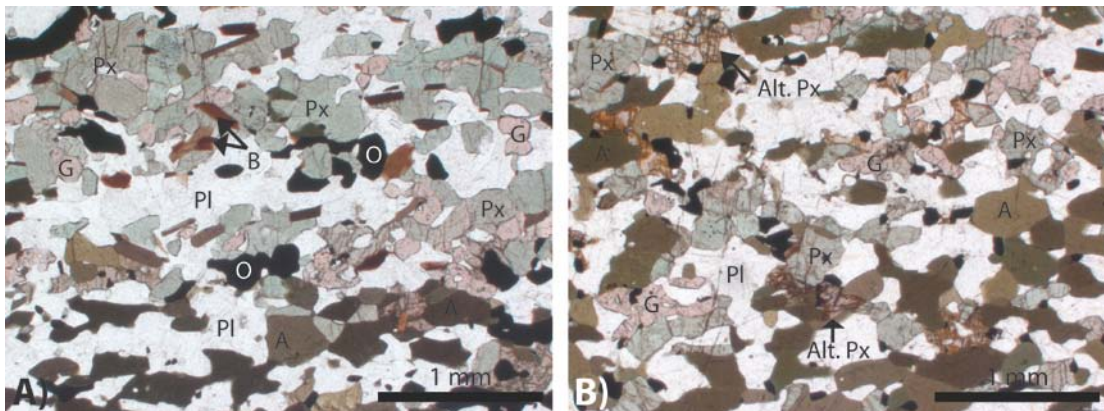

Figure 7. Microphotographs of A) an unaltered amphibolite from sample 2 and B) altered amphibolite from sample 5. The minerals are abbreviated as follows: plagioclase (PI), amphibole (A), pyroxene (Px), garnet (G), quartz (Q), biotite (B), opaque (O) and altered (Alt.).

Discussion

The different geophysical logs detect different physical properties, so a combination of several logs is the optimal solution (e.g. Takahashi *et al.*, 2006). In this particular case drill cores exist to verify and calibrate the interpretation of the geophysical logs. However it also becomes clear that it is necessary to go into details to find the explanation for the ambiguous resistivities of the amphibolites and dolerites in the two core drillings. Microscopy of rocks taken from the drill cores improve the interpretation of the geophysical logs and gives more detailed information of the geology, as fractures and weathering.

The natural gamma log detects decay of potassium (^{40}K) amongst others and indicates the presence of minerals as clays and feldspar rich in this element. The higher count in gneiss is thus due to the high content of alkalispar whereas the low counts in the amphibolites and dolerites is due to lack

of minerals rich in potassium. Generally the gamma log cannot detect fractures, however if they are clay filled the gamma log would detect this. The caliper log gives good indications of fractures. In the resistivity log a low resistivity of 800–2000 Ωm is interpreted as fracture and weathered zones. Gneisses without any fractures or weathering have a resistivity of 7000–10000 Ωm . In KB5336 the change in behaviour of the resistivity log below 120 meter was clearly due to higher fracture frequency. Generally KB6105 contains less fractures and weathered zones than KB5336 which is seen in a steadier resistivity and calliper log signal. Only a few joint sets and weathered zones were observed in KB6105.

The resistivities of the amphibolites in KB5336 (Fig. 5a) are around 7000 Ωm whereas the resistivity of the amphibolite and dolerites in KB6105 (Fig. 5b) are around 2000 Ωm . Further the resistivity is constant within amphibolite layers in KB5336 whereas it fluctuates in the amphibolite and dolerite layers in KB6105. The two boreholes are only separated with 770 metre so the large difference in resistivity is ambiguous. In both cases the amphibolites seemed to be fresh with no weathering and only few fractures or joints (Fig. 5). The overall theory is that the abrupt differences in resistivity in a lithological unit are caused by large fractures and/or weathering. But why the large difference in resistivity of two apparently similar amphibolites? The visual inspection could not provide an explanation. The structure and texture of the amphibolites seemed similar and there were no weathering or fractures visible. Is this due to difference in mineralogy of two different generations of amphibolite? Is it conductive microfractures? Or weathering of minerals? Therefore the petrography and the mineral composition were investigated. No large difference in mineralogy or texture was observed that could cause the large difference in resistivity were observed and can thus be ruled out as an explanation.

Oxides and sulphides are conductive minerals and would thus lower the resistivity of the rock (Carmichael, 1989). However, in the thin sections the opaque phase occurs as isolated crystals and therefore is not the reason for lower resistivity of the amphibolite in KB6105 (Fig. 7). If the opaque phase should decrease the resistivity of the amphibolite significantly, it should form an interconnected conducting network. Such a network could be formed by microfractures filled with probably ironhydroxides and chlorite which are present in the studied amphibolites. However, microfractures are present in both the high and the low resistivity amphibolites and can thus not explain the difference in resistivity.

Initial weathering and alteration of the amphibolite on the other hand can explain the lower resistivity of the amphibolites and dolerites in KB6105. This is evident from commonly altered pyroxenes in the amphibolite in sample 5 in KB6105, in particular in the bottom part of the amphibolite. The pyroxenes have clearly been hydrated forming new hydrous minerals along the edge and cleavage planes of the crystals. Hydrous minerals are more conductive than non-hydrous silicate minerals and have therefore lowered the resistivity of the weathered amphibolite. Simultaneously minor hydrous minerals have precipitated along grain boundaries, thus forming a conductive network able to decrease the resistivity of the amphibolite. The weathering was most likely initiated during uplift of the Hallandsås Horst, in this particular case, by introduction of water into the lithological contact between the bottom part of the amphibolite in sample 5 in KB6105 and the underlying gneiss.

Geophysical logging has proven to be very useful for determining lithology and providing a large number of details as position of joints and weathering state. Especially it will become a useful tool when the geophysics is calibrated with observations in core drilled holes and afterwards used in cheaper percussion drilled holes. The advantage with borehole geophysics is that the measurements are continuous. Thus where there is not full core recovery the geophysical log will give information from the missing parts and provide a more complete knowledge of the geology. Therefore, correct

use of geophysical logs is valuable in pre-investigations for large construction projects, as this will minimize unpleasant surprises, delays and keep the costs within the budget. Geophysical logging is fast and relatively cheap and the knowledge gain from geophysical data can potentially avoid problems during construction and extra costs. Therefore we find that it is of utmost importance that geophysical logging is performed prior to large construction projects.

Conclusion

The visual inspection show clearly that lithology changes, fractures, joint sets, and even initial weathering in crystalline rock can be identified by geophysical logs. Overall the geophysical logs, especially the resistivity logs, show that KB6105 is more homogenous than KB5336 which has more fractures and weathered zones. In this case the used geophysical logs showed the following characteristics:

Natural gamma: Low count when the lithology is amphibolite or dolerite and high count when the lithology is gneiss which is due to the difference in the content of potassium-rich minerals. It is however not possible to distinguish between amphibolite and dolerite as this distinction is based on texture.

Caliper: Increased diameter in a limited interval indicates fractured rock and the wider peaks are joint sets and weathered zones.

Normal resistivity: The short normal resistivity has a shallower penetration depth than the long normal. On the other hand the short normal the long gives a smoother image. Low resistivity (800 – 2000 Ωm) indicates where the rock is fractured and/or weathered, high resistivity (> 7000 Ωm) shows fresh rock. In the lower 60 meters of KB5336 the resistivity in the short normal fluctuates more compared to the rock mass due to an additional fracture direction.

The low resistivity of the amphibolite in KB6105 compared to the high resistivity amphibolites in KB5335 is the result of initial stage of weathering which is evident from altered pyroxenes. The resistivity logs can thus detect even low grades of weathering of amphibolites which can be important for the mechanical properties of the rock.

Even though geophysical logging gives great details there might be some ambiguity in the interpretation of the results. To answer some of the questions it can become necessary to go into even greater details. Microscopy of thin sections can help answering some of the questions as demonstrated.

References

- Carmichael R.S. 1989. *Practical Handbook of physical properties of rocks and minerals*. 1st edn. CRC Press, Inc. Boca Raton, Florida.
- Dahlin, T., Bjelm, L., and Svensson, C. 1999. Use of electrical imaging in site investigations for a railway tunnel through the Hallandsås Horst, Sweden. *Quarterly Journal of Engineering Geology* 32, 163-172.
- Daniels, J.J. and Keys, W.S. 1990. Geophysical Well Logging For Evaluating Hazardous Waste Sites. In *Geotechnical and Environmental Geophysics, Vol 1, Review and Tutorial* (ed. S.H. Ward), pp. 263-285. Society of Exploration Geophysicists.
- Ellis, D.V. and Singer, J.M. 2007. *Well Logging for Earth Scientists*. 2nd edn. Springer.
- Ernstson, K. 2006. Magnetic, geothermal, and radioactivity methods. In *Groundwater Geophysics - A tool for hydrogeology* (ed. R. Kirsch), pp. 275-320. Springer.

- Graversen, O. 2009. Structural analysis of superposed fault systems of the Bornholm horst block, Tornquist Zone, Denmark. *Bulletin of the Geological Society of Denmark* 57, 25-49.
- Howard, K.W.F. 1990. Geophysical Well Logging Methods for the Detection and Characterization of Fractures in Hard Rock. In *Geotechnical and Environmental Geophysics, Vol 1, Review and Tutorial* (ed. S.H. Ward), pp. 287-307. Society of Exploration Geophysicists.
- ISRM. 1980. *Rock characterization, testing and monitoring, ISRM suggested methods*. 1st edn. Pergamon Press.
- ISRM. 1981. Suggested methods for geophysical logging of boreholes. *International Journal of Rock Mechanics and Mining Sciences and Geomechanics Abstracts* 18, 67-84.
- Liboriussen, J., Ashton, P., Tygesen, T. 1987. The tectonic evolution of the Fennoscandian Border Zone in Denmark. *Tectonophysics* 137, 21–29.
- Nielson, D.L., Linpei, C., and Ward, S.H. 1990. Gamma-Ray Spectrometry and Radon Emanometry in Environmental Geophysics. *Geotechnical and environmental geophysics, vol 1: Review and tutorial* (ed. S.H. Ward) pp. 219-250. Society of Exploration Geophysicists.
- Paillet, F.L. and Ellefsen, K.J. 2005. Downhole Application of Geophysics. In *Near-Surface Geophysics*. (ed. D.K. Butler), pp. 439-471. Society of Exploration Geophysicists.
- Rafat, G., Lehmann, B., Toumani, A., and Rueter, H. 2001. Characterisation of rock ahead and around tunnels and boreholes by use of geophysical and geological methods. *International Journal of Rock Mechanics and Mining Sciences* 38, 903-908.
- Rasmussen, K.R. and Bai, W. 1987. Logging in deep water wells in central Jutland, Denmark. *Boreas* 16, 393-404.
- Schepers, R., Rafat, G., Gelbke, C., and Lehmann, B. 2001. Application of borehole logging, core imaging and tomography to geotechnical exploration. *International Journal of Rock Mechanics and Mining Sciences* 38, 867-876.
- Segesman, F.F.. 1980. Well-logging method. *Geophysics* 45, 1667-1684.
- Swedish Geological Survey., 1981. SGU Ser. Af nr 133 Flygmagnetiska Kartan 4C Halmstad SV:Af nr 133. (*Map*)
- Takahashi, T., Takeuchi, T., and Sassa, K. 2006. ISRM Suggested Methods for borehole geophysics in rock engineering. *International Journal of Rock Mechanics & Mining Sciences* 43, 337-369.
- Wikman, H. and Bergström, J. 1987. *Beskrivning till Berggrundskartan Halmstad SV*. 1st edn. Uppsala, Swedish Geological Survey.

Appendix A Point counts of minerals in thin sections

Amphibolite

Mineral	KB5336	KB5336	KB5336	KB6105	KB6105
	123.92-124	126.73-126.81	133-133.06	86.73-86.78	91.57-91.61
	Sample 1	Sample 2	Sample 3	Sample 4	Sample 5
	[%]	[%]	[%]	[%]	[%]
Plagioclase	41	38	38	38	38
Hornblende	27	20	25	26	29
Clinopyroxene	14	19	16	16	15
Garnet	7	9	9	10	9
Quartz	4	7	8	4	3
Biotite	<1	3	<1	<1	<1
Opaque	6	5	5	5	5
Other	<1	<1	<1	<1	<1
Number of samples	1055	1034	958	1044	1035
Observations	Joints		Joints		Joints

Gneiss

Mineral	KB5336 109.55-109.57 Sample 6 [%]	KB6105 61.97-62.03 Sample 7 [%]
Plagioclase	40	38
Quartz	33	28
Alcalifeltspar	15	17
Microcline	6	11
Hornblende	2	4
Biotite	1	1
Opaque	1	1
Other	2	<1
Number of samples	1210	1180

Paper 5 Danielsen, B.E. and Dahlin, T. (2009)

**Comparison of geoelectrical imaging and tunnel documentation
at the Hallandsås Tunnel, Sweden.**

Engineering Geology. 107: 118-129

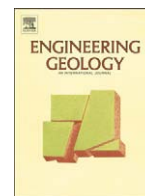

Comparison of geoelectrical imaging and tunnel documentation at the Hallandsås Tunnel, Sweden

Berit E. Danielsen*, Torleif Dahlin

Engineering Geology, Lund University, Sweden

ARTICLE INFO

Article history:

Received 6 August 2007

Received in revised form 29 April 2009

Accepted 16 May 2009

Available online 27 May 2009

Keywords:

Comparison

Tunnel documentation

Geoelectrical imaging

Lithology

Q

RQD

Weathering

Water leakage

Resistivity

Dynamic prognosis

ABSTRACT

For construction in rock a thorough pre-investigation is important in order to avoid unforeseen conditions which may delay the work. It is crucial to remember the results from this investigation in the further work, and use the experience from the construction to update the geological prognosis and reduce the uncertainties. Different geophysical methods have proved valuable tools in such investigations. In this work the electrical imaging is evaluated with regards to the method's applicability. The evaluation is done qualitatively by comparing the electrical imaging with tunnel documentation from a tunnel in Southern Sweden. By evaluating the result continuously when making the tunnel a more detailed geological prognosis can be compiled and used in the continued work with the tunnel. The parameters used for the comparison are lithology, Q, RQD, weathering and water leakage. The result was that virtually every change in electrical resistivity image coincides with a change in rock conditions. The general trend was that high resistivity corresponded with good quality gneiss whereas low resistivity corresponds to poor quality rock e.g., high weathering, low RQD, low Q and/or several lithological contacts. The intermediate resistivity is often amphibolites or rock with water bearing fractures. The results were supported by in-situ resistivity measurements inside the tunnel and resistivity logging in a core drilling. Geoelectrical imaging proved to give valuable information for a detailed geological model, which could be compiled for a section where the tunnel had not yet been drilled as a help for planning of the continued tunnel work. As is the case other geophysical methods it is clear that for the interpretation of data a priori information about the geological setting is necessary.

© 2009 Elsevier B.V. All rights reserved.

1. Introduction

Construction in rock with unforeseen quality or conditions can result in delays which in the end are expensive. Therefore a thorough pre-investigation has to be carried out in order to establish the best geological model possible. Different geophysical methods have proven to be valuable tools in the early stages of the large scale pre-investigations (Dahlin et al., 1999; Rønning, 2003; Cavinato et al., 2006; Ganerød et al., 2006). An engineering geological prognosis is based on the pre-investigation report and the purpose is to form the base for design and estimation of e.g., reinforcements and grouting (Swindell and Rosengren, 2007). By using the experience gained during construction work a more detailed interpretation of the geoelectrical data can be done, and an updated and geological prognosis with less uncertainties can be compiled. The original prognosis is optimised based on the data available when it was compiled, but with a new prognosis the construction work is better prepared for unforeseen conditions. No matter how good a prognosis is it is still an estimate of how the ground

conditions are and there will always be room for improvements. It might be that nothing is added, but the prognosis becomes more certain. Therefore it is always a good idea to learn from the parts already drilled, and use it to update the geological model and its reliability. In this way the data are used in a more optimal way and the value of the money spent on the data is higher.

The compilation of the first prognosis is bound to involve uncertainties. A traditional method for obtaining information about the rock properties is core drilling. Core drillings are considered giving very exact information about the geological properties. However they have the limitation that they only give point information. An important issue is also that, to some degree, they are interpreted, preferably by a geologist. When considering the documentation from the core drillings the human factor has to be acknowledged; the geologist can misinterpret the rock quality when it is based on core drillings. For example the scale and orientation of a sample can give a wrong impression and in addition two different persons do evaluate the classification systems differently. For compiling a useable prognosis the geologist/engineering geologist has to be certain which parameters are important for the construction work. In some cases time is used for gathering information which is not necessary for the actual work, while other information is neglected. In order to make

* Corresponding author.

E-mail address: berit.danielsen@tg.lth.se (B.E. Danielsen).

the classification easier the pre-investigation has to be planned and carried out so that it gives suitable information and is decision oriented. If the desired result of the investigations is unclear it might cause unnecessary time consuming and expensive investigations (Stanfors et al., 2001). It is advisable to use multiple methods in any rock engineering investigation in order to reduce the uncertainty.

The International Society for Rock Mechanics (ISRM) has suggested the use of geophysics to obtain more information about the rock properties (Takahashi, 2004; Takahashi et al., 2006). The different geophysical methods exploit the contrast in the physical properties of the subsurface. The most commonly used geophysical method in tunnel construction is seismic refraction (Cardarelli et al., 2003; Ganerød et al., 2006). Often the method is used with advantage for locating the bedrock surface and evaluating the mechanical properties of soil and rock. In Klose et al. (2007) multi-dimensional seismic data, achieved from sidewalls of a tunnel, are used to characterize and predict engineering geological conditions. The very low frequency method (VLF) is an electromagnetic method that is often used for detecting sub-vertical electrical conductors such as fracture zones (Reynolds, 1997; Stanfors et al., 2001). The geomagnetic method measures the variation in the content of magnetic minerals in the rock. This is a fast method but a disadvantage is that the method is sensitive towards buried scrap metal and electrical installations (Stanfors et al., 2001). Geoelectrical imaging is used for measuring the spatial variation in the resistivity of the subsurface. Most rock forming minerals are insulators so the resistivity of crystalline rock depends largely on the amount and quality of water present and the degree of weathering of the rock. Therefore rock without water bearing fractures or weathering has a high resistivity whereas clay-weathered rock or rock with water bearing fractures has a considerably lower resistivity (Parasnis, 1997; Binley and Kemna, 2005). A joint interpretation of different methods with different sensitivities will produce the best result. Before deciding on a certain method, knowledge about the expected contrasts in physical properties has to be obtained from e.g., previous measurements, geological maps and geological history. Evaluations of the different geophysical methods used in connection to construction of a number of tunnels (Dahlin et al., 1999; Rønning, 2003; Cavinato et al., 2006; Ganerød et al., 2006) showed that geoelectrical imaging gave good results. In addition it was a time and cost effective method compared to other geophysical methods.

The aim of this paper is to show what the resistivity method is able to resolve by comparing the results from geoelectrical imaging and tunnel documentation. The aim is also to show how the experience can be used to update the geological prognosis. The prognosis becomes more reliable and can therefore reduce the number of uncertainties in the continued construction work. Ongoing work in a tunnel provides the opportunity to compare actual rock type, Q, RQD, weathering, water leakage and amount of grout used with the measured resistivity profiles. The resistivity values are extracted at different levels from the inverted data. This allows a good evaluation of how the resistivity model varies with depth.

In this specific case the tunnel work is already started and the pre-investigations carried out. First of all it is a good example of showing how reliable the method is and secondly it can be shown how the data can be used in the continued tunnel work. Just because the pre-investigations are finished the data should not be forgotten. Based on the experience from the finished parts of the tunnel updated geological prognoses can be made for the sections not yet built and used in the planning of the tunnel work. This can be repeated more or less continuously or at regular intervals throughout the construction phase.

In this study the construction of twin track tunnels through the Hallandsås Horst in southern Sweden (Fig. 1) is used. The work was initiated in 1992 and is ongoing. Problems related to high ingress of water and difficult rock conditions have resulted in major delays to the

work. The tunnel has 100 to 150 m overburden and a high water pressure, which in combination with strict requirements on limiting the water ingress, even during the construction period, have caused problems for the project. Despite considerable pre-grouting operations a substantial amount of water has been leaking into the tunnels with a critical lowering of the groundwater table as a consequence (Banverket, 2005). The use of an advanced shielded tunnel boring machine has mitigated these problems and the tunnel is now being built with a water tight segmental lining.

Since the beginning of the project different geophysical methods have been used, e.g., geoelectrical imaging, ground based magnetic, VLF and seismic refraction. Especially geoelectrical imaging and ground based magnetic has been useful. Geoelectrical imaging has pinpointed large weak zones and magnetic measurements have located dolerite dykes.

The tunnel is constructed 100 to 150 m below the surface whereas the measured geoelectrical data has an investigation depth of maximum 160 m. The resolution of the geoelectrical method gets inferior with depth. Thus the resolution at tunnel level is not suitable for a quantitative and statistical comparison of the geoelectrical imaging and tunnel documentation. Still the qualitative comparison gives valuable information about the rock properties which are useful in the large scale pre-investigation of a tunnel construction.

2. Geological setting

The Hallandsås Horst is the most northern of the Scanian horsts. These are the result of a tectonic activity, which has been going on since Silurian time. The uplifted blocks have a NW–SE orientation and occur in the so called Tornquist Zone. This tectonic element stretches all the way to the Black Sea (Wikman and Bergström, 1987). The Hallandsås Horst is 8–10 km wide, 60–80 km long and reaches an elevation of 150 to 200 m in the tunnel area. Towards the north the slope is steep whereas it has a gentler slope towards the south (Dahlin et al., 1999).

Crystalline Precambrian rocks make up most of the bedrock, whereas sedimentary rocks cover minor areas. Gneisses of presumably intrusive origin dominate the area. Amphibolites of several generations occur and the oldest often are seen as minor layers or schlieren parallel to the layering in the gneiss. The younger amphibolites have mostly distinct contacts and cut across the structures of the older bedrock. These younger dykes often run in the NNE–SSW direction (Wikman and Bergström, 1987).

The dominant fractures are oriented in NW–SE direction corresponding to the Tornquist Line. Another important fracture system has a NNE–SSW direction and is younger than the NW-system. The bedrock is intruded by a set of younger dolerite dykes with their trend parallel to the Scanian horsts. These so-called NW-dolerites are steeply dipping dykes that can have a width up to 50 m (Wikman and Bergström, 1987). These dolerite dykes are seen as very distinct linear positive anomalies on the aeromagnetic map (Swedish Geological Survey, 1981). On the aeromagnetic maps it is even possible to see the NNE and NE fracture system because they disconnect the positive anomalies associated with the dolerite dykes (Wikman and Bergström, 1987).

The substantial deep weathering of the bedrock began during Triassic time and periodically continued during the Cretaceous. This resulted in a weathering to mainly kaolinite. The weathering is documented in core drillings from the area. In the core drillings it is also clear that there is often chlorite in the fractures (Wikman and Bergström, 1987).

The Hallandsås Horst is an important groundwater reservoir. There are two types of reservoirs; one in the soil layer (<20 m thick) and one in the bedrock. In the bedrock the water flows in a large and complex web of fractures. The tectonic activity has made it possible for

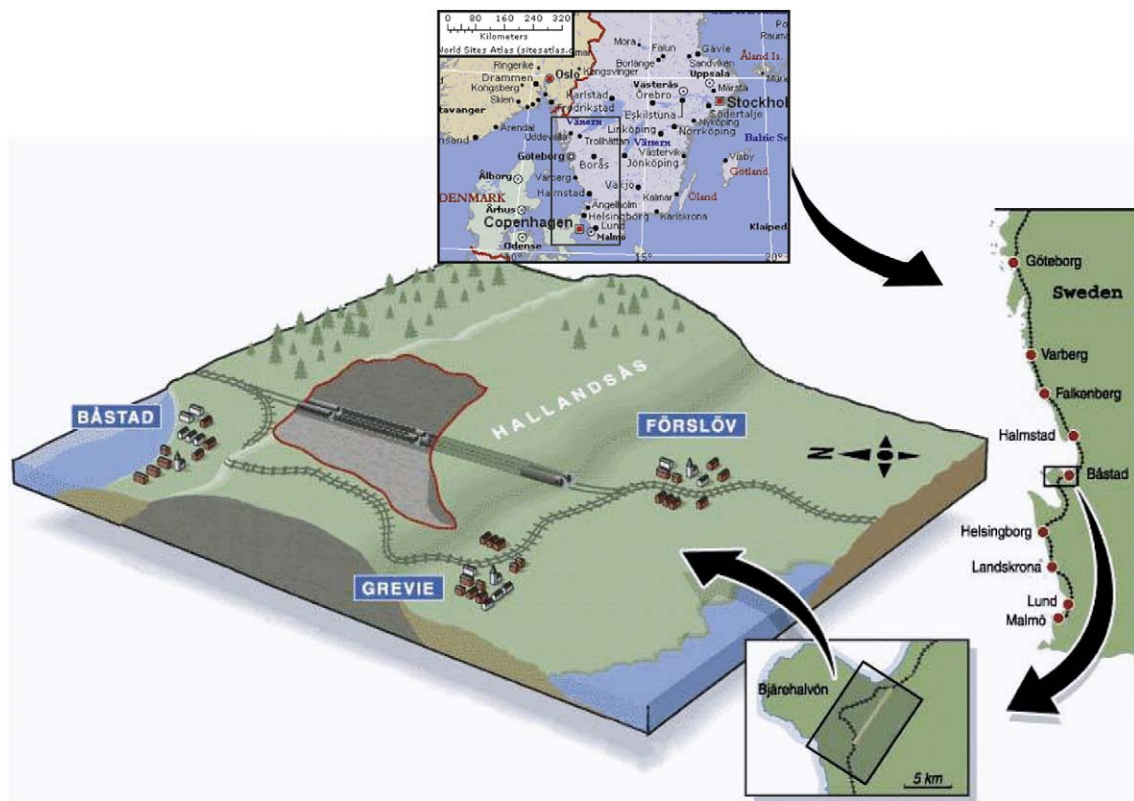

Fig. 1. Location of the Hallandsås Horst. Modified from Öhrling (2007) and Sitesatlas.com (2008).

the large amounts of water to be contained within the bedrock. At tunnel level there is a water column of 100–150 m which results in high water pressure. The groundwater level is strongly influenced by the construction of the tunnel and is therefore monitored very thoroughly (Banverket, 1996 and www.banverket.se).

3. Geoelectrical imaging

Geoelectrical imaging is used for measuring the spatial variation of resistivity of the subsurface. The resistivity of the different geological materials differs greatly from about $10^{-6} \Omega\text{m}$ in minerals such as graphite to more than $10^{12} \Omega\text{m}$ for dry quartzitic rocks. Most rock forming minerals are insulators so the resistivity of crystalline rock depends basically on the amount of water present and the degree of weathering of the rock. Therefore rock without water bearing fractures or weathering has a high resistivity whereas clay-weathered rock or rock with water bearing fractures has a considerably lower resistivity (Palacky, 1987; Parasnis, 1997; Binley and Kemna, 2005).

In this paper no introduction to the geoelectrical imaging is given. For more information see Binley and Kemna (2005), Reynolds (1997) and Takahashi (2004).

Generally the depth of investigation of the method increases with increasing electrode distance. The current will seek to obtain the lowest possible total resistance on the path between the two current electrodes. For example a very low resistive layer near the surface would prevent the current from penetrating deeper into the ground. In this case, the resolution of the deeper layer will be limited. By contrast, a very high resistive layer close to the surface would force the

current down to a less resistive lower layer. The depth of investigation therefore depends on the resistivity of the different layers as well as the largest electrode separation.

The resistivity data were measured as 2D profiles while the subsurface is 3D. To assume a 2D earth might in some cases be problematic. This would create 3D effects in the resistivity data; especially in this particular case where the geology changes relatively fast. In order to obtain the best 2D situation the profiles should always be perpendicular to the geological structures. The Hallandsås Horst profiles are more or less perpendicular to the NW–SE structures.

3.1. Geoelectrical imaging at the Hallandsås Horst

In connection with the tunnel project almost 20 km of CVES profiles have been measured between 1995 and today using different versions of the ABEM Lund Imaging system (ABEM, 2007). During this time the measuring instruments, computers and software have developed and become faster and with better resolution. The measurements were done using the roll-along technique allowing a continuous data acquisition. For more information about the technique used at the Hallandsås tunnel, the reader is referred to Dahlin et al. (1999).

For comparison in this paper, old data of good quality has been re-processed using the newest version (ver. 3.55.77) of the software RES2DINV. This program uses a 2D finite element calculation method. For the inversion of the data the robust inversion is used which favours a blocky geology (Loke, 2004). This is done because at the Hallandsås there are often sharp boundaries and vertical structures.

Fig. 2. Visualization of resistivity and mapped data from both tunnels in the northern part of the Hallandsås tunnel. The mapped data were rock type, fractures, RQD, Q, weathering, water leakage and amount of grout. The resistivity data are shown as full model and as sub-models extracted at 60 m, 30 m and 20 m above sea level. The low resistive zones are marked with L1, L2 and L3. High resistive zones are marked with H1, H2 and H3. The area with intermediate resistivity is marked I1. Here the tunnel base is at approximately 15 m above sea level.

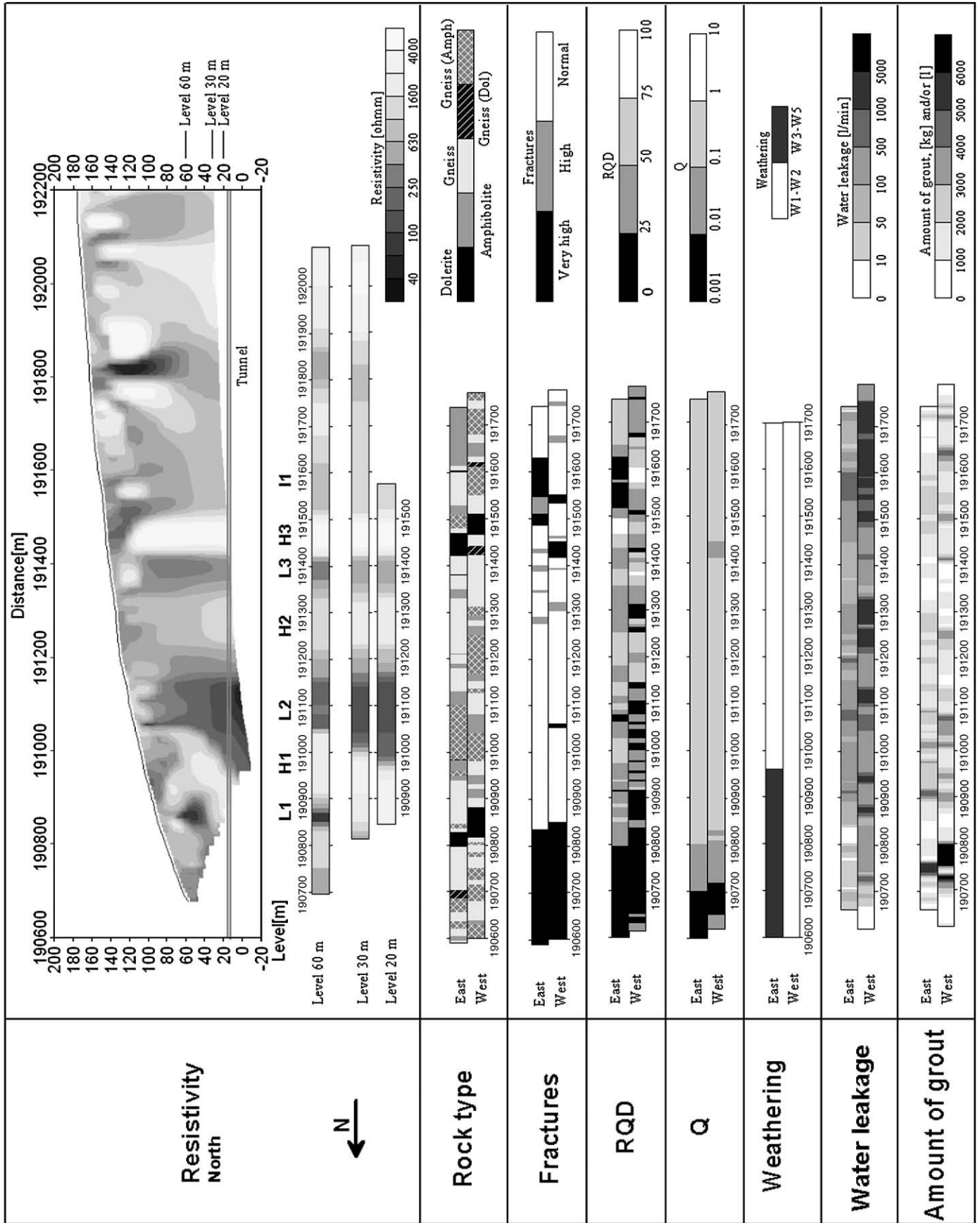

The resistivity data was measured using a Schlumberger electrode configuration with a cable layout of 800 m and an electrode spacing of 10 m. An exception is in the southern part of the profile where the measurements were done using a Wenner electrode configuration with cable layout of 400 m and an electrode spacing of 5 m. With the electrode layout and arrays used, the depth of investigation is 120–160 m for the long Schlumberger layout and 60 m for the short Wenner layouts. For long intervals, the tunnel is located 150 m below ground surface. To compensate for the inadequate penetration depth the full resistivity model is shown as well as sub-models extracted at different levels from the model. By showing the different sub-models a clear image of the resistivity change with depth is obtained. Instead of the commonly used colourful resistivity images, the images here are shown in grey scale. This allows an easier comparison (Fig. 2) to mapped tunnel parameters such as RQD, Q, weathering, water inflow etc. which are also presented in a similar grey scale.

4. Tunnel documentation

The long history of the Hallandsås tunnel has given rise to different types of approaches both for tunnel construction and documentation. Documentation exists from regular drill and blast at the early stages of the tunnel construction. This was done from both ends and in both tunnels more or less concurrently. However the work was stopped because of problems caused by large amounts of ground water leaking into the tunnel. Therefore this type of mapping only exists for 1 km in the north and for 800 m at the south end of the tunnel.

Use of a TBM (tunnel boring machine) has resulted in another type of documentation. The geologist can only get access for mapping the tunnel face when the TBM is stopped during mounting of the lining. This means the face is only visible every 2.2 m. So far 1200 m has been mapped in a single tunnel.

In both types of documentation the lithology is mapped. In several instances there are different types of rock present in one tunnel face. When there is more than 50% gneiss in a face but with different rock types also present, such as amphibolite, it is written as e.g., gneiss (amph).

4.1. Documentation from drill and blast

During the period when drill and blast was done the parameters mapped were rock type, fracture zones, weathering, RQD, Q, water leakage and amount of grout used. The water leakage was measured for every grouting round (fan). The weathering was classified according to ISRM 1980 (ISRM, 1980). The weathering was only divided in two intervals; W1 to W2 and W3 to W5. W1–W2 is fresh rock while W3–W5 is weathered rock. The RQD is the Rock Quality Designation as proposed by Deere et al. (1967).

Barton et al. (1974) developed the rock mass quality system (Q-system) evaluating the rock quality using six different parameters. The six parameters are: RQD, the number of joint sets (J_n), the roughness of the weakest joints (J_r), the degree of alteration or filling along the weakest joints (J_a), and two parameters which accounts for the rock load (SRF) and water inflow (J_w). In combination these parameters represent the block size, the inter-block shear strength and the active stress.

The degree of fracturing is another parameter which was observed. As a starting point the rock is all fractured, but the degree of fracturing

Table 1

The rock class defined exclusively for the Hallandsås tunnel.

Rock class	RQD	Block size (cm)	Weathering
1	75–100	>60	W1
2	50–75	20–60	W1
3	25–50	5–20	W1
4	0–25	0–5	W1
5	25–50	5–20	W2
6	0–25	0–5	W2
7a	25–50	5–20	W3
7	0–25	0–5	W3
8	25–50	5–20	W4
9	0–25	0–5	W4
10	0–25	0–5	W5

Based on Banverket (2002).

increases at several places. Thus the fracturing is divided into three different categories; normal, high and very high fracturing.

During the tunnel construction the fractures are grouted to water from leaking into the tunnel. The amount of grout is stated with the unit of kg and/or l. This is done because there were used two different types of grout; cement and chemical grout. The first has the unit kg and the latter has the unit litres.

4.2. Documentation from the TBM

For the use with the TBM, a site specific classification system was developed exclusively for the Hallandsås. The rock masses were divided into 11 different classes based on RQD, block size and weathering. The classification can be seen in Table 1.

Thus the parameters mapped are rock type, weathering, block size and rock class. Based on the weathering and block size the RQD can be assessed (see Table 1). For several probe drilling ahead of the TBM the water flow was measured. The measured water flow is a mean value for the whole probe length of 10 to 40 m. The exact position of the water bearing fractures is therefore not distinguished in this analysis. In the zones where the water leakage is less than 10 it shall be regarded as if there were no probe drillings or no flow measurements and not that there was no water leakage.

5. Comparison of resistivity data and tunnel documentation

In order to evaluate the results from the resistivity method the data are compared with the existing tunnel documentation. The comparison is done merely by visual evaluation because of the difference in the scale of the data and the inadequate penetration depth. The resolution of the tunnel documentation is in decimetres whereas the resistivity data are in tens of metres. Because of the inadequate penetration depth of the resistivity data the sub-models at different levels are primarily used for the comparison in order to give an impression of how the structures changes with depth. This is possible because of the vertical structures in the area.

All data is plotted in grey scale in order to give a rapid impression of the rock quality. Dark colours are poor rock mass quality while light colours are good quality. The only exception is rock type where the colour does not have any significance with regards to the mechanical quality of the rock.

The coordinate system used is the chainage system used by the Swedish National Rail Administration.

Fig. 3. Visualization of resistivity and mapped data from both tunnels in the southern part of the Hallandsås tunnel. The mapped data were rock type, fractures, RQD, Q, weathering, water leakage and amount of grout. The resistivity data are shown as full model and as sub-models extracted at 60 m, 40 m and 20 m above sea level. The low resistive zones are marked L4, L5 and L3. The zones with intermediate resistivity are marked I2 and I3. Here the tunnel base is at approximately 15 m above sea level.

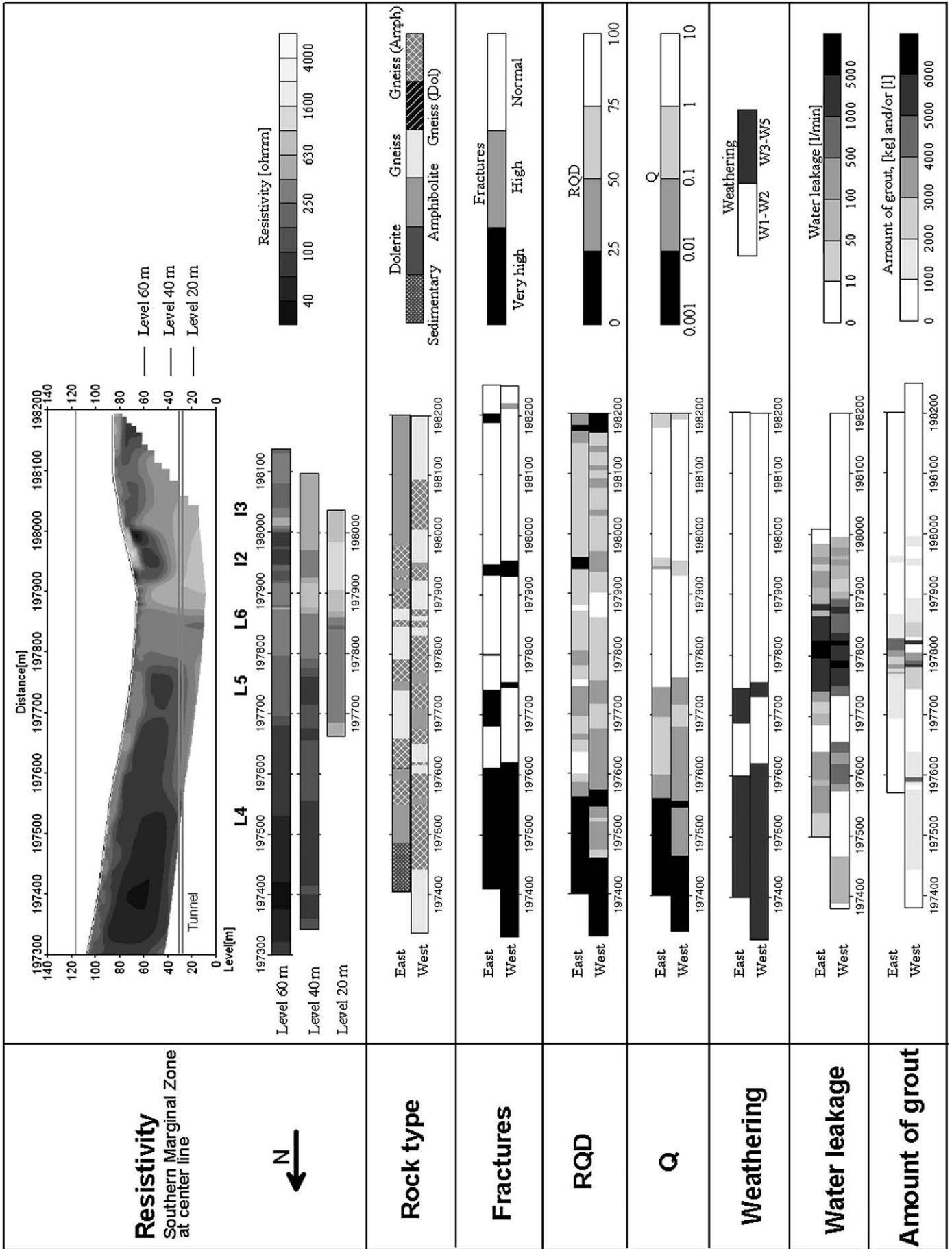

6. Results

The comparison between resistivity and the mapped data is done for three different sections of the tunnel here referred to as North, South and TBM. The distance between the centrelines of the two tunnels is 25 m.

To make the evaluation of the results easier different resistivity zones are marked with a letter and number. The resistivity data are divided into three types e.g., low (L), high (H) and intermediate (I). The dividing into the different resistivity zone is done so that it covers the same resistivity intervals in all three tunnel sections. The intervals can be disputed and discussed.

6.1. North

Fig. 2 shows the resistivity and the mapped data from the northern part of the twin track tunnel. The mapped data are rock type, fracture zones, RQD, Q, weathering, water leakage and amount of grout. What is obvious when evaluating the water leakage from the two parallel tunnels is that the amount of water in the western tunnel is much higher than in the eastern tunnel (~factor 10). This is probably due to the fact that the western tunnel was constructed prior to the eastern. Therefore the ground water reservoir was drained by the first tunnel and there was not the large amount of water accessible for leaking into the second tunnel. Furthermore, considerable pre-grouting was carried out for the west tunnel which may influence also the east tunnel. As a consequence the water leakage data for the eastern tunnel is biased.

The mapping of the lithology in the two parallel tunnels shows that the dolerite dykes are striking NE–SW following the structural trend.

The sub-models of the resistivity data shows three zones with low resistivity along the part with tunnel documentation, but only two, L2 and L3, are clearly seen in all three depth slices. Interesting zones in the resistivity data can also be areas with very high resistivity. Three areas with high resistivity (~4000 Ω m) are visible in the depth slices.

6.2. South

Fig. 3 shows the resistivity data and the tunnel documentation for the southern part of the Hallandsås tunnel. This part of the tunnel is dominated by poor rock quality. The resistivity data was measured with Wenner array and had a maximum layout on 400 m. This might have implications for the resolution at the tunnel level. In a later field campaign resistivity was measured from chainage 190800 to 197600 using the Schlumberger array and layouts of 800 m. The southernmost part of this can be seen in Fig. 4. Thus there is an overlap between the resistivity sections shown in Figs. 3 and 4. The deeper model in Fig. 4 confirms that the resistivity at tunnel level between chainage 197300 and 197950 is low.

In this part of the resistivity section three areas are categorized as low resistive zones and two as intermediate zones. In Table 2 the dominant observations from the tunnel documentation are summarized.

6.3. Tbm

In Fig. 4 the tunnel documentation from the use of a TBM is compared with the resistivity data from the same section. The mapped data were rock type, RQD, block size, weathering, rock class and water leakage. The resistivity data are shown as the full model and as sub-models extracted at 60 m and 25 m above sea level.

In this part of the resistivity section three low resistive zones are identified. Only L7 and L9 are visible in both levels. Two high resistive areas and three areas with intermediate resistivity are visible. In Table 4 the corresponding properties from the tunnel documentation are summarized.

7. Discussion

The comparison shows that a change in resistivity in most cases is related to some kind of change in the rock conditions. High resistivity corresponds well with good quality gneiss as the dominant rock type. For the northern part this is seen at H2 and H3, Fig. 2 (Table 3). In the part drilled with a TBM, Fig. 4 (Table 4), it is observed at H4 and H5. In general low resistivity corresponds to a varying lithology with fractured contacts or merely rock with very poor quality (RQD < 25). This is very clear in large areas of the southern part of the tunnel, Fig. 3. The intermediate resistivity often coincides with areas of amphibolite with an average RQD of 25–75 (fair quality). An example of this is in Figs. 3 and 4 where the I3, I4 and I6 all are amphibolites. But in some cases the intermediate resistivity corresponds to increased water content. The presence of water can decrease the resistivity of a rock with an otherwise fair rock quality. This is the case in the northern part, Fig. 2 (Table 3) at I1 where there is an increased amount of water.

For reference, in-situ measurements of the resistivity were performed on some representative samples of the different rock types in the tunnel. For this purpose a special device was made for measuring the resistivity using a Wenner-configuration with spacing between the electrodes equal to 0.05 m and to 0.1 m. The measured apparent resistivities are shown in Fig. 5. It is seen that the resistivity of the amphibolite is between 800 and 4000 Ω m, whereas for gneiss it is scattered between 1000 and 11,500 Ω m. This emphasises the difficulty in distinguishing between these two lithologies. But it is quite clear that the amphibolite does not attain the same high resistivity as the gneiss. High resistivity is clearly an indication of gneiss whereas an intermediate resistivity is often amphibolite that to some degree may be mixed with gneiss. This supports the observations from comparing tunnel documentation with the resistivity data.

This is also confirmed by geophysical logging of the core drilling KB6105. The position of the drill-hole is marked with a line in Fig. 4. The drill-hole is positioned 30 m west of the tunnel line inclined at an angle of 20° from vertical. From the full resistivity section it is seen that the drill-hole passes through a low resistivity zone (250–600 Ω m), L7. In Fig. 6 the lithology is plotted together with the resistivity log and natural gamma log. The core drilling is dominated by gneiss but with two layers of dolerite at 37 m and 47 m. From 85 m to 92 m the lithology is amphibolite. It is interesting that the resistivity of these three zones is as low as 2000 Ω m, whereas the gneiss has a resistivity of 4000 to 10,000 Ω m. In addition they give low gamma readings. In the gneiss there is a thin layer with a very high gamma count which is seen neither in the lithology log nor the resistivity log. The low resistive zone L7 is well explained in the tunnel documentation by several lithology contacts. Thus the disagreement between the resistivity seen in the profile and in the resistivity log might be explained by the fact that the geology is very complex and that the drilling is made 30 m from the resistivity profile. The different scale of resolution of the methods is also essential for the result.

Although in most cases there is a correlation between resistivity and rock conditions, there are also exceptions. The example from the northern part of the tunnel is at H1, Fig. 2 (Table 3). There is a high resistivity and therefore it is expected to be good quality rock without weathering and water. The rock in the eastern tunnel is highly weathered whereas the western tunnel is fresh. On the other hand the RQD is lower in the western than in the eastern tunnel. In agreement with the expectation there is gneiss, mixed with amphibolite in some places. The result from the investigation at L3 is also difficult to interpret. There is increased water leakage but the RQD is not as low as expected. Thus the low resistivity here might be an effect of the inversion or 3D effects. Lack of resolution can also cause a low resistive body at a shallower depth to apparently extend

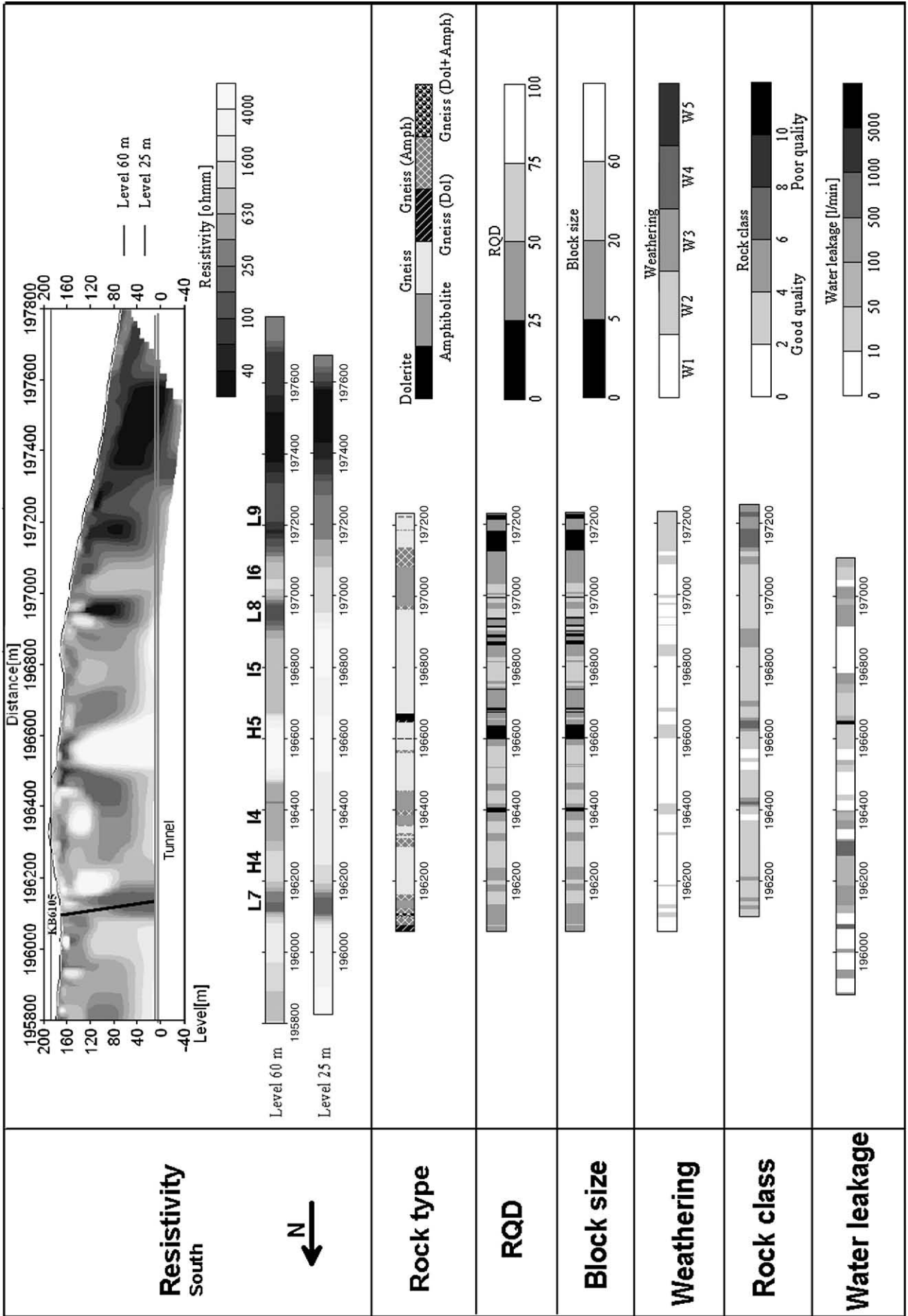

Fig. 4. Visualization of resistivity and mapped data from the southern part of the Hallandsås tunnel. The mapping is done in front of the TBM at every operational stop. The mapped data were rock type, RQD, block size, weathering, rock class and water leakage. The resistivity data are shown as full model and as sub-models extracted at 60 m and 25 m above sea level. The low resistive zones are marked with L7, L8 and L9. High resistive zones are marked with H4 and H5. The areas with intermediate resistivity are marked I4, I5 and I6. Here the tunnel base is at approximately 15 m above sea level. The position of core drilling KB6105 is marked with a line.

Table 2

Summation of the dominating properties of the rock in the intervals based on the resistivity data for the southern part of the tunnel.

Resistivity	Rock type	Fracturing	RQD	Q	Weathering	Water
L4	Gneiss/amphibolite	Very high	0–25	<0.01	W3–W5	E: Int. W: Low
L5	E: gneiss W: gneiss (amph)	E: very high W: normal	25–50	0.01–0.1	W3–W5	E: Int. W: Low
L6	E: gneiss W: gneiss (amph)	Normal	50–75	1–10	W1–W2	High
I2	E: gneiss (amph) W: gneiss	Very high	E: 0–25 W: 25–50	0.1–1	W1–W2	Int.
I3	E: amphibolite W: gneiss(amph)	Normal	50–75	1–10	W1–W2	Low

L is low, H is high and I is intermediate resistivity. The most likely explanation to the resistivity value in the interval is indicated with bold and italic.

Table 3

Summation of the dominating properties of the rock in the intervals based on the resistivity data for the northern part of the tunnel.

Resistivity	Rock type	Fracturing	RQD	Q	Weathering	Water
L1	Dolerite	Very high	0–25	0.1–1	E: W3–W5 W: W1–W2	E: Low W: High
L2	Gneiss(amph)	Normal	E: 25–50 W: 0–25	0.1–1	W1–W2	E: Low W: High
L3	Gneiss	Normal	E: 25–50 W: 50–75	0.1–1	W1–W2	Med.
H1	E: Gneiss W: Gneiss/Amph	Normal	E: 25–50 W: 0–25	0.1–1	E: W3–W5 W: W1–W2	E: Low W: High
H2	E: Gneiss W: Gneiss(amph)	Normal	E: 25–50 W: 0–25	0.1–1	W1–W2	E: Low W: High
H3	Dolerite/Gneiss	Normal	E: 75–100 W: 25–50	0.1–1	W1–W2	Low
I1	E: Gneiss W: Gneiss(amph)	E: Very high W: Normal	E: 0–25 W: 75–100	0.1–1	W1–W2	High

L is low, H is high and I is intermediate resistivity. The most likely explanation to the resistivity value in the interval is indicated with bold and italic.

down to tunnel level. For I1 the documentation, especially for the eastern tunnel, shows that the rock has a low RQD (0–25) and is very highly fractured. On the other hand the western tunnel has a very high RQD (78–100). Additionally there is a large amount of water in the western tunnel. A low RQD is expected to give low resistivity while the high amount of water is expected to give an intermediate resistivity. But in this case it is also interesting to see that the rock is fresh. Therefore in this instance it has an intermediate resistivity due to increased water content.

In the documentation from the TBM, Fig. 4, the RQD at H5 shows a relatively large area with a value of less than 25 and a very high water leakage in an otherwise fair rock quality. It is expected that such a large area with poor rock quality and very high water leakage would give low resistivity. Instead there is quite high resistivity. The water might flow in few fractures and the high water leakage may be caused by the high pressure. The nature of the fractures cannot be evaluated in the type of flow measurement performed in the probe drillings. The conclusion is that the zone most likely is too small to create an anomaly in high resistivity gneiss with good quality. Another example is at L8 in the same section where the RQD shows many narrow zones with values lower than 25. The water leakage shows an intermediate flow that is slightly increased. There is no clear indication of this problematic area because the resistivity data at tunnel level does not show any low resistivity whereas at 60 m.a.s.l. it does. Here the problem might be that 20 m.a.s.l. is deeper than the resistivity method can resolve with the layout and electrode array used.

Table 4

Summation of the dominating properties of the rock in the intervals based on the resistivity data for the TBM drilled part of the tunnel.

Resistivity	Rock type	RQD	Weathering	Water
L7	Several contacts	25–50	W1	Intermediate but increased
L8	Gneiss/amph.	25–50	W1	Intermediate
L9	Gneiss	0–25	W2	No values
H4	Gneiss	25–50	W1	Low
H5	Gneiss	50–75	W1	Low/Very high
I4	Amphibolite	25–50	W1	Int./high
I5	Gneiss	25–75	W1	Intermediate/no values
I6	Amphibolite	25–75	W1	Intermediate

L is low, H is high and I is intermediate resistivity. The most likely explanation to the resistivity value in the interval is indicated with bold and italic.

A probable reason for the divergence between the tunnel documentation and the resistivity data might be the 3D effects in data. The tunnels are separated by 25 m and still there is a large difference between the lithology and rock properties in the eastern and western tunnels, emphasising the high variability in the rock mass properties.

Another issue is the difference in the scale of the data. The tunnel documentation shows every small change in the rock conditions. For the resistivity method to be successful a zone has to be sufficiently large and have large enough contrast in the physical properties. A complicating factor in this particular tunnel project is that the tunnel is situated at a large depth giving poor resolution at tunnel level. The resistivity data are measured at the ground surface 120–150 m above the tunnel. Therefore these data have a lower resolution at tunnel level than the detailed tunnel documentation. Thus a zone can be too narrow to be visible in the resistivity data if the resistivity contrast with the surrounding rock is not sufficiently large. The scale of resolution is tens of metres.

In the mapping of the tunnel there is the human factor to acknowledge. The mapping of RQD, weathering and lithology is a subjective assessment done by geologists at the tunnel site. There is not a big difference in the rock properties if the rock has a RQD of e.g.,

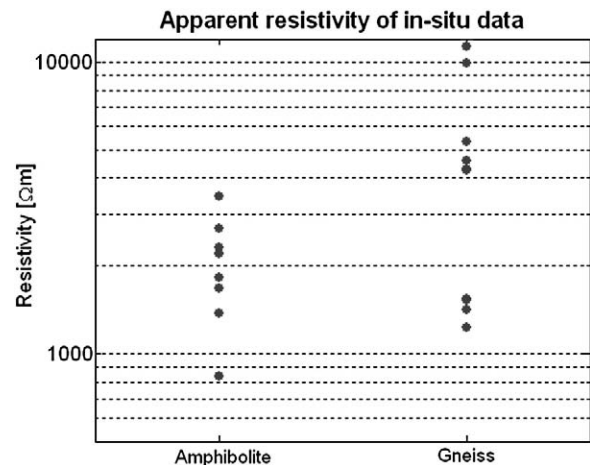
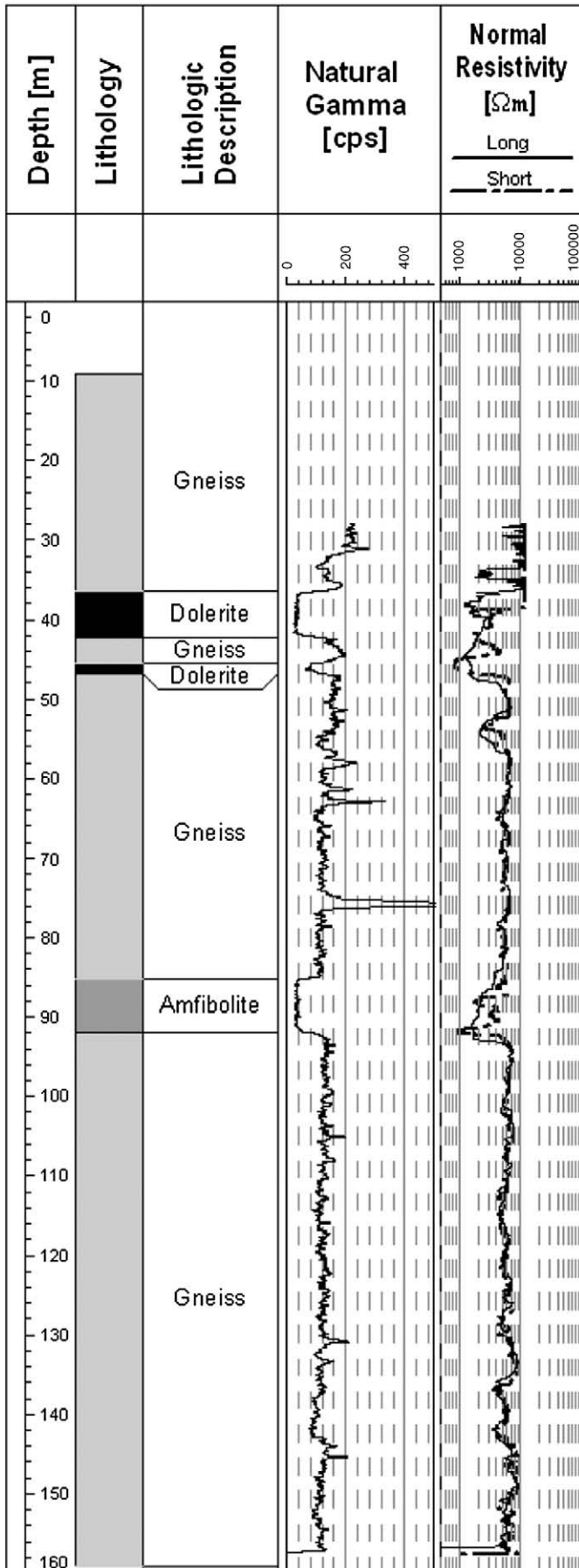

Fig. 5. The apparent resistivity of amphibolite and gneiss measured at different locations in the tunnel.



28 or 23 but it means that the conditions look more serious in the plot. So the mapping is somewhat subjective and might bias the results of this study in some parts.

By using the experience from the evaluation made in this paper a new geological prognosis can be compiled and used in the further work with the TBM. Fig. 7 shows a part of a new prognosis for a part of the tunnel. In Fig. 7a the resistivity profile for the whole tunnel is seen. Fig. 7b shows a close-up of a 1200 m long section in the central part where the TBM had not yet drilled through when this study was finished. In Fig. 7c the rock type, RQD and weathering is estimated based on the resistivity data and ground based magnetic data (not shown). The dolerite in the southern part of the selected section is pinpointed by the magnetic data. The low RQD and high weathering in the contact zone between the dolerite and the gneiss is based on general knowledge about the rock conditions in such zones. The old prognosis showed that from 194400 to 194650 there should be rock with a RQD lower than 25. This is to some extent confirmed in the updated version of the model where the RQD is between 25 and 50. In the old model there are several dolerite dykes between 194100 and 194400 with a poor rock quality in the contact zones. This is not confirmed by the resistivity data. In the old model, as well as in the updated version, the dolerites are pinpointed by ground based magnetic surveys. It was noted in the first version that the magnetic anomalies might be due to noise, and because they are not indicated in the resistivity data they are left out of the updated model. The next step for the prognosis would be to estimate its reliability. This brings up a lot of new issues and will therefore not be discussed in this paper.

8. Conclusion

For the Hallandsås tunnel project in southern Sweden several kilometres of resistivity measurements (CVES) have been made. Therefore the tunnel documentation gives a good opportunity to perform an evaluation of the resistivity data. It has previously been shown that three large zones with problematic rock conditions could be identified using geoelectrical imaging (Dahlin et al., 1999). In this case the contrast in resistivity between rock of good quality and rock of poor quality is sufficiently large to be resolved beyond any doubt. It is probable that more information can be extracted from the remaining part of the 2D profile and used in the construction work.

The ability of geoelectrical imaging to indicate changes in rock conditions by means of varying resistivity makes it a valuable tool in the pre-investigation. With the tunnel drilled 150 m beneath the surface and in an area with this type of geology, the scale of resolution is tens of metres. Thus in this example the method cannot resolve bodies smaller than this. The comparison of the tunnel documentation and the geoelectrical imaging showed that a change in resistivity often corresponds to some kind of change in the rock mass properties. The resistivity can be divided into three categories, i.e., high, low and intermediate resistivity. These three categories can generally be correlated to certain types of rock mass conditions. The high resistivity corresponds well with gneiss with a good quality. Intermediate resistivity is most likely amphibolite with a relatively good rock quality. This is also supported by in-situ measurements in the tunnel where the only rock with very high resistivity is gneiss. Also the resistivity log showed that amphibolite has lower resistivity than gneiss. In some cases the intermediate resistivity can also be water bearing rock. The low resistivity is rock of a poor quality which is deeply weathered or has many contacts between different lithologies.

Fig. 6. The lithology from the core drilling KB6105 plotted together with the natural gamma and long/short normal resistivity log.

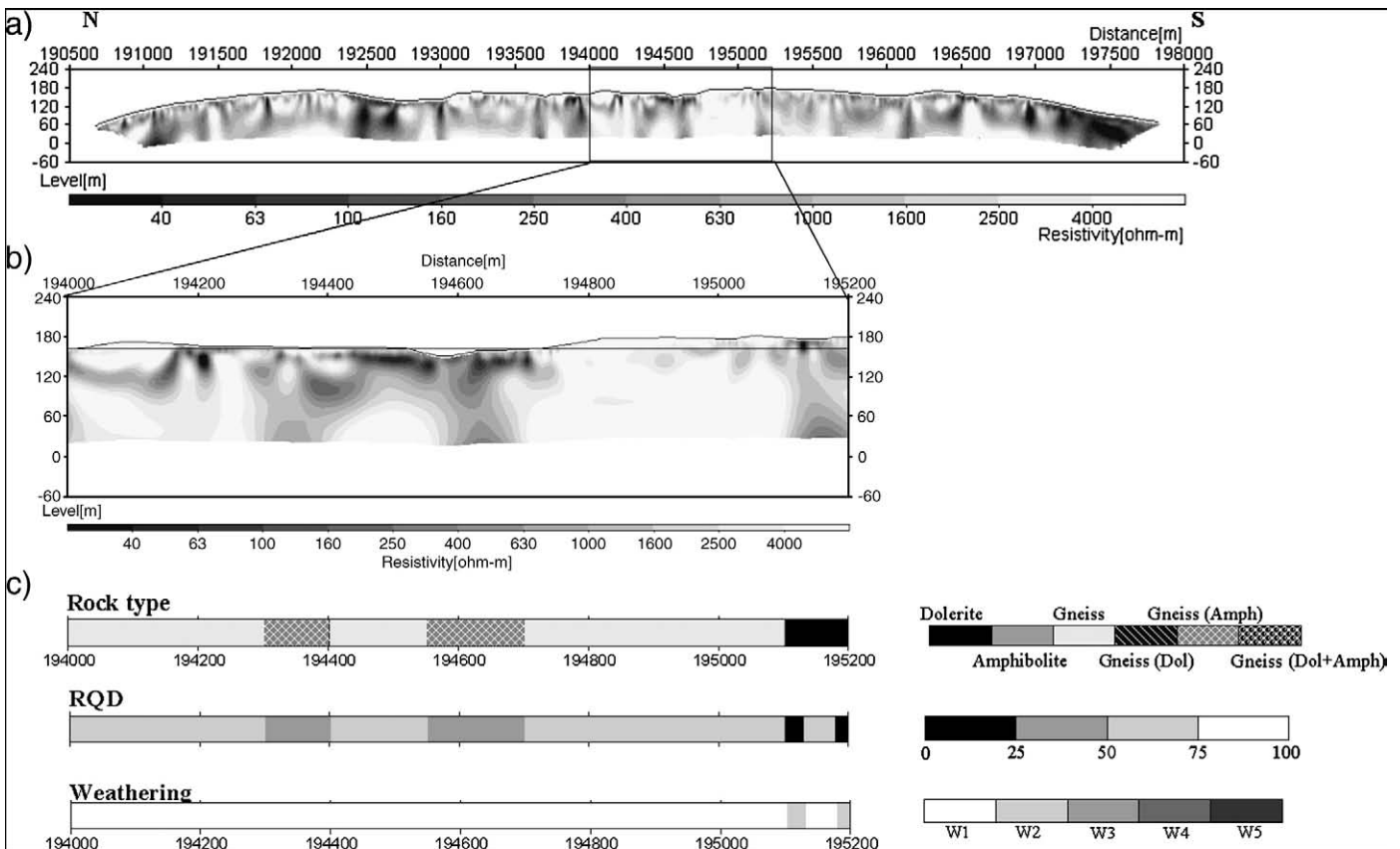

Fig. 7. a) The full resistivity section for the Hallandsås tunnel in grey scale. b) Close-up on 1200 m in the central part of the tunnel section. c) Estimated rock type, RQD and weathering for the 1200 m long section.

However it is not always possible to relate the changes in resistivity to a specific rock condition or property. This may be caused by differences in the scale of the compared data. The resistivity data has a much lower resolution than the tunnel documentation. Another reason can be 3D effects in the 2D resistivity profiles. In addition a certain amount of bias can occur in the mapping of the tunnel parameters because different geologists may interpret the conditions differently.

The decision makers can use the changes in resistivity as an indication of the need for caution when planning for example an underground rock construction. The experience from the Hallandsås tunnel construction can be used to improve the interpretation capability of the resistivity image. Previously there has been a focus on low resistivity zones in order to identify poor rock conditions. The comparison has shown that the high resistivity zones tend to indicate good quality rock. This is as important for the contractor to know as the location of poor quality rock. Even though the resistivity method is not able to interpret every change in the conditions it still contributes with important information within the limitations of its resolution. Geoelectrical imaging contributes to reduce the number of uncertainties. In combination with other investigations the ambiguity and uncertainty might be further reduced.

As a tool for pre-investigations, resistivity imaging has the advantage that it is more time and cost efficient than other alternatives, e.g., seismic refraction. It has to be stressed that the method should not stand alone. A priori information about the geological setting is crucial and the results have to be followed up by additional measurements, i.e., with other types of geophysical methods exploiting other physical parameters or by 3D resistivity measurements. The measurements can then be used as a base for deciding where to perform geotechnical drillings.

When the resistivity data has been used for the pre-investigations they should never be put aside. It is important to make a dynamic geological prognosis and always use new information and experience to update the interpretation of the data. No matter how good a prognosis is, it is still an estimate of the ground conditions and there will always be room for improvements. It might be nothing is added, but the model becomes more certain. By performing a comparison as in this paper the value of the time and money spent on the investigations becomes higher and the tunnel projects might be better prepared for unforeseen rock conditions.

References

- ABEM, 2007. Instruction Manual, Terrameter SAS 1000/4000. ABEM Instrument AB, ABEM Product Number 33 0020 26.
- Banverket, 1996. Handling 11.5 Primärdata bergundersökningar Hallandsåsen. Bilaga D Geohydrologiska undersökningar inkl. underbilagor D1-D7. In Banverket, Södra Banregionen (In Swedish).
- Banverket, 2002. Handling 8.3 Geologisk-hydrogeologisk prognos. Banverket, Södra Banregionen. (In Swedish).
- Banverket, 2005. Project Hallandsås – In brief Banverket, Banverket, Projekt Hallandsås, Vistorpsvägen 96, SE-260 91 Förslöv. (In Swedish).
- Barton, N., Lien, R., Lunde, J., 1974. Engineering classification of rock masses for the design of tunnel support. *Rock Mechanics and Rock Engineering* 6 (4), 189–236.
- Binley, A., Kemna, A., 2005. DC resistivity and induced polarization methods. In: Rubin, Y., Hubbard, S. (Eds.), *Hydrogeophysics*. Springer.
- Cardarelli, E., Marrone, C., Orlando, L., 2003. Evaluation of tunnel stability using integrated geophysical methods. *Journal of Applied Geophysics* 52 (2–3), 93–102.
- Cavinato, G.P., Di Luzio, E., Moscatelli, M., Vallone, R., Averardi, M., Valente, A., Papale, S., 2006. The new Col di Tenda tunnel between Italy and France: integrated geological investigations and geophysical prospecting for preliminary studies on the Italian side. *Engineering Geology* 88 (1–2), 90–109.
- Deere, D.U., Hendron, A.J., Patton, F.D. and Cording, E.J., 1967. Design of surface and near surface construction in rock. In *Failure and breakage of rock*, proc. 8th U.S. symp. rock mech. (ed. C. Fairhurst), 237–302. New York: Soc. Min. Engrs, Am. Inst. Min. Metall. Petrolm Engrs.

- Dahlin, T., Bjelm, L., Svensson, C., 1999. Use of electrical imaging in site investigations for a railway tunnel through the Hallandsås Horst, Sweden. *Quarterly Journal of Engineering Geology* 32, 163–172.
- Ganerød, G.V., Rønning, J.S., Dalsegg, E., Elvebakk, H., Holmøy, K., Nilsen, B., Braathen, A., 2006. Comparison of geophysical methods for sub-surface mapping of faults and fracture zones in a section of the Viggja road tunnel, Norway. *Bulletin of Engineering Geology and the Environment* 65 (3), 231–243.
- ISRM, 1980. In: Brown, E.T. (Ed.), *Rock characterization, testing and monitoring, ISRM suggested methods*. Pergamon Press.
- Klose, C.D., Loew, S., Giese, R., Borm, G., 2007. Spatial predictions of geological rock mass properties based on in-situ interpretations of multi-dimensional seismic data. *Engineering Geology* 93, 99–116.
- Loke, M.H., 2004. RES2DINV ver. 3.54 M.H.Loke on www.geoelectrical.com.
- Öhrling, T., 2007. Tunnelsträckning. www.banverket.se (Map).
- Palacky, G.J., 1987. Resistivity characteristics of geologic targets. In: Nabighian, M.N. (Ed.), *Electromagnetic methods in applied geophysics*. Society of exploration geophysics.
- Parasnis, D.S., 1997. *Principles of Applied Geophysics*. Chapman and Hall.
- Reynolds, J.M., 1997. *An Introduction to Applied and Environmental Geophysics*. John Wiley & Sons.
- Rønning, J.S., 2003. Miljø- og samfunnstjenlige tunneler. Sluttrapport delprosjekt A. Forundersøkelser NGU. Rapport nr. 2003.007 (In Norwegian).
- Sitesatlas.com, 2008. www.sitesatlas.com (Map).
- Stanfors, R., Triumf, C.-A., Emmelin, A., 2001. *Geofysik för bergbyggare: SveBeFo* (Swedish Rock Engineering Research), Stockholm. (In Swedish).
- Swedish Geological Survey, 1981. SGU Ser. Af nr 133 Flygmagnetiska Kartan 4C Halmstad SV. (Map).
- Swindell, R., Rosengren, L., 2007. Ingenjörsgelogiska prognoser inom projekt citybanan in Bergmekanikdagen 2007. SveBefo. (In Swedish).
- Takahashi, T., 2004. ISRM suggested methods for land geophysics in rock engineering. *International Journal of Rock Mechanics and Mining Sciences* 41 (6), 885–914.
- Takahashi, T., Takeuchi, T., Sassa, K., 2006. ISRM suggested methods for borehole geophysics in rock engineering. *International Journal of Rock Mechanics & Mining Sciences* 43 (3), 337–369.
- Wikman, H., Bergström, J., 1987. *Beskrivning Till Berggrundskartan Halmstad SV* Swedish Geological Survey, Uppsala. (In Swedish).

Paper 6 Danielsen, B.E., Norberg, T. and Rosén, L. (2010)

**Framework for Value of Information Analysis applied to
geophysical methods used for pre-investigation.**

Manuscript

Framework for Value of Information Analysis applied to geophysical methods used for pre-investigation

Berit Ensted Danielsen¹, Tommy Norberg² and Lars Rosén³

¹Engineering Geology, Lund University, S-223 63 Lund, Sweden

²Department of Mathematical Sciences, Chalmers University of Technology and Göteborg University, S-412 96 Göteborg, Sweden

³Department of Civil and Environmental Engineering, Chalmers University of Technology, S-412 96 Göteborg, Sweden

Introduction

A major problem when constructing tunnels is unforeseen rock conditions e.g. water leakage and changes in rock mechanical properties. The contractor needs as much information about the ground conditions as possible in order to provide a sound financial offer, prepare adequate equipment and to organize a relevant contingency plan. An unforeseen event can delay the project with further costs as a consequence. To reduce the uncertainty an engineering geological prognosis is necessary. This prognosis should be based on geophysical measurements supported by drillings (Danielsen, 2007).

The results of the geophysical measurements usually have to be processed and evaluated by a geophysicist. Only the geophysicist knows the sensitivity and resolution of the methods. Thus the engineer does not always have appropriate expectations of the advantages and limitations of the geophysical methods. On the other hand the geophysicist does not always have detailed understanding of what the engineer requires; e.g. at what scale is information needed? One task for the engineer and the geophysicist is to find a common language (Danielsen, 2007). Value of information analysis (VOIA) might be an approach for communicating with the decision-makers.

VOIA is an aid in decision-making in complex problems. It can help to create a rational design strategy for investigation programmes. The method is based on Bayesian statistics and cost-benefit analysis and is suitable for problems where different alternatives are evaluated and compared, e.g. the design of an investigation programme when the number of measurements or investigations needs to be determined. In VOIA the cost for new information is compared with the reduced risk for taking an economically unfavourable decision. The cost and the time it takes to obtain better information must be compared to what can be saved by modifying the investigation programme. New information is only interesting when it can change the outcome of the decision and thus is of value for the decision-maker. The cost of an investigation or measurement should be less than the expected savings; otherwise the investigation should not be made (Back, 2006; Bedford and Cooke, 2001; Freeze et al., 1992).

In the petroleum industry the VOIA approach has been used for evaluating if seismic and controlled-source electromagnetic data can reduce some of the uncertainty in the reservoir properties (Buland et al., 2010; Eidsvik et al., 2008). However to our knowledge the VOIA approach has never been applied to geophysical methods used in pre-investigations for rock tunnel construction. One of the

central tasks in this study is to evaluate how good different geophysical methods are at detecting problematic rock conditions in otherwise good rock. Because, such an estimation can be biased (based on experience, affiliation etc.), our approach is to ask geophysical experts to judge this in order to get a more objective result. The experts will be presented to a number of simulations of possible rock volumes and the estimate should be based on those. The experts opinion is then the foundation for the probability used in the VOIA. It is also important to remember that the estimate is only valid for a specific geological setting which will be described further down. The example is hypothetical but is inspired by an actual tunnel construction in Sweden.

Statistical methods and Value of Information Analysis

There are two predominant ways of conceiving probability. The traditionalists (also called frequentists) consider probability as a frequency with which things occur in a long series of trials, e.g. rolling a dice. The Bayesians on the other hand consider probability as a degree of belief and therefore admit probability statements on states of nature. In this way states of nature are considered as variables, and not unknown constants. This is consistent with engineering geology which is heavily depending on observations and uncertainty of the observations. The expert might have discretely sampled data (measurements) of how the state of nature is. Based on this the engineering geologist is expected to make a statement about the state of nature without actually having solid proofs. The engineering geologist makes an estimation of how the geological conditions are and what events are probable (Baecher and Christian, 2003).

Tunnel construction is decision making under risk where pre-investigation should reduce the risk of something unexpected happening. If the unexpected happens it will in most cases cost more time and money than a thorough pre-investigation. However a thorough pre-investigation is no guarantee that no problems will arise, because there is a probability that problematic zones are missed or underestimated. Nevertheless is an optimised pre-investigation necessary for making the best decisions with the information available in order to reduce the risk for unexpected geological problems. In VOIA the data worth is assessed by comparing the cost of data collection with the expected value of the risk reduction the data provides. The data worth assessment lead to a strategy for a rational design of a field investigation program. Such a strategy must address the questions 1) what to measure, 2) how many methods to use, succession of the methods and how many profiles, and 3) where to make the measurements (Freeze et al., 1992; Norberg and Rosén, 2006).

Additional information should always aim at reducing uncertainties, and the decision to make measurements or change the design of the pre-investigation program, is based on cost-effectiveness. A pre-investigation program is regarded as cost effective as long as the expected benefit associated with the new information is larger than the measurement costs. Another way of expressing this is that measurements are only justified if the sampling has potential to change decision (Andersson et al., 2004). An insufficient pre-investigation will make it difficult to distinguish between *nothing found* because there was nothing there or *nothing found* because of deficiencies in the site-investigation (Back, 2007).

In a VOIA different action alternatives are considered and an objective function ϕ_j is applied for each alternative j (Back, 2007):

$$\phi_j = B_j - C_j - P(F)_j \cdot C_{Fj} \quad (\text{Eq. 1})$$

where B_j is the benefit and C_j is the investment cost. The last term is the risk term, where $P(F)_j$ is the probability of failure and C_{Fj} is the cost of failure. Failure could also be seen as an event or that something unexpected occurs. In this particular VOIA, failure in the prior analysis is when the rock is weak.

By collecting more information (more measurements/drillings), the value of the risk term is reduced and therefore the expected value of the objective function increases. The decrease in the risk term is proportional to the probability of failure. The expected increase in the objective function, ϕ_j , is the value of the pre-investigation (Back, 2007).

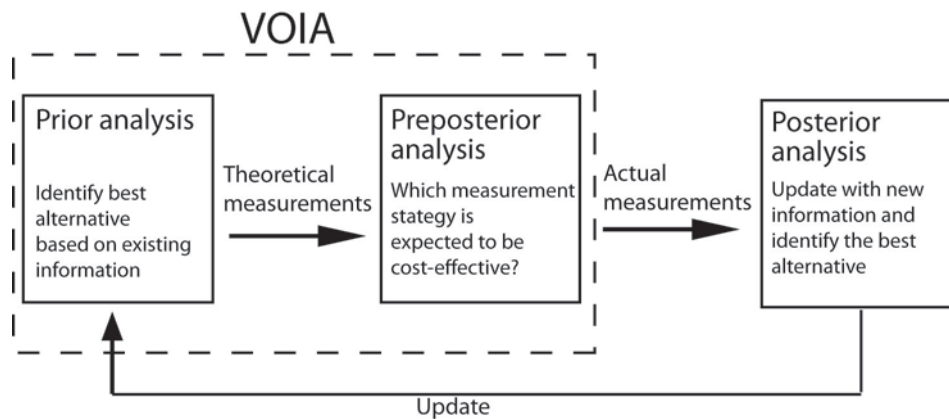

Figure 1. The central parts of the VOIA (modified from Back, 2006).

The VOIA consists of a *prior analysis* and a *preposterior analysis*, see figure 1. A part of the preposterior analysis is to calculate the *value of new information*. The VOIA only covers the planning of the pre-investigation and no calculation of the posterior value with actual data is performed. However the VOIA can be updated when another round of measurement is considered and in that case all new information should be considered when the probabilities are estimated.

The *prior analysis* is solely based on the knowledge available before any pre-investigation is carried out. It results in an expected total cost or benefit. The Bayesian inference allows the use of prior knowledge, which is very important when there is little data. Prior knowledge might come from old data (e.g. from before pre-investigation), or from some form of expert judgement (Bedford and Cooke, 2001).

The prior value of the best decision alternative is calculated as the prior objective, ϕ_{prior} (Back, 2006; Back, 2007):

$$\phi_{prior} = \max(0, P(F) \cdot C_F - C) \quad (\text{Eq. 2})$$

where $P(F)$ is the probability for failure (weak rock), C_f is the cost if failure occur and C is the cost for preventing failure. The cost if failure occurs is in this case the additional cost if the project is unprepared for weak rock and it entails a delay.

The probability $P(F)$ that an event F happens is said to be the marginal probability or the prior probability. An event can happen, F , or not happen F' . Two events might be related somehow, and the joint probability are said to be *conditional*. Thus given that an event happens, it can either be detected, $P(D|F)$, or not detected, $P(D'|F)$. Given that an event does not happen, it can either be detected, $P(D|F')$, or not detected, $P(D'|F')$. This is illustrated by the event tree in figure 2. (Baecher and Christian, 2003; Davis, 2002). The $P(D'|F)$ and $P(D|F')$ are the reliability of the different alternatives and describes the accuracy of the investigation.

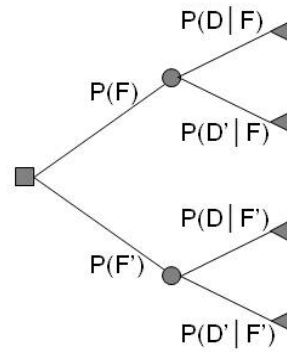

Figure 2. Event tree of the preposterior analysis. The square is a decision node, circles are chance nodes and triangles are terminal nodes, indicating the outcomes (modified from Back (2006)).

The *preposterior analysis* is done after the pre-investigation program is defined, but before the actual measurements are carried out (Back, 2006; Back, 2007). The preposterior analysis is also calculated using equation 6.1 but is based on the expected information from the pre-investigations. This results in an objective function, $\phi_{prepost}$:

$$\phi_{prepost} = \max(0, P(F|D') \cdot C_F - C) \cdot P(D') + \max(0, P(F|D) \cdot C_F - C) \cdot P(D) \quad (\text{Eq. 3})$$

The investigations have no value if both parts of the sum are negative. In order to calculate the conditional probabilities $P(F|D')$ and $P(F|D)$ Bayes' theorem is used. It relates the conditional and prior probabilities of event F and D :

$$P(F|D) = \frac{P(D|F)P(F)}{P(D|F)P(F) + P(D|F')P(F')} \quad (\text{Eq. 4})$$

and from the law of probability (Back, 2007; Bedford and Cooke, 2001; Olofsson, 2005; Sturk, 1998):

$$P(D) = P(F)P(D|F) + P(F')P(D|F') \quad (\text{Eq. 5})$$

The value of the new information (or *Expected Value of Information (EVI)*) is calculated as (Back, 2006):

$$EVI = \phi_{prepost} - \phi_{prior} \quad (\text{Eq. 6})$$

The EVI is always nonnegative and a value of information is only obtained if the pre-investigation has the potential to change the decision. The expected preposterior value is equal to or larger than the prior value because we make better-informed decisions (Eidsvik et al., 2008).

It is possible to estimate the value of a perfect sampling program, thus there are no errors in the measurements, without performing a preposterior analysis. This is the *expected value of perfect information* (EVPI) and represents an upper limit on EVI and the maximum exploration budget that can be justified without performing a preposterior analysis (Back, 2007).

The EVI does not consider the cost, C_{preinv} , of the pre-investigation program. If the cost of the investigations should be considered the *Expected Net Value (ENV)* is calculated:

$$ENV = EVI - C_{preinv} \quad (\text{Eq. 7})$$

A *posterior analysis* should be performed after the actual pre-investigation has taken place. In this analysis the real worth of the obtained information is calculated and a new updated VOIA is performed using the posterior as prior information (Bedford and Cooke, 2001).

The idea of updating a prior distribution to obtain a posterior distribution gives an important role to the expert. The expert has to decide on the form of the prior distribution. This combination of giving weight to experts but still allowing for scientific evidence makes Bayesian reliability very useful in geo-science (Bedford and Cooke, 2001).

Tunnel project

The tunnel project used in this example is hypothetical but derived from a real tunnel case in the central part of Sweden (an 800 metre long railroad tunnel). In the central parts of this tunnel the maximum overburden is 25 to 30 metres. The tunnel is constructed using drill and blast with a tunnel face of 6x6 m². The geological setting in the area is dominated by greywacke and granite. There are elongated sections with pegmatite and dolerite dykes. The valleys that are found on both sides of the tunnel coincide with regional fracture zones that vary between 10 and 20 metres wide. The soil deposits are relatively thin and in some areas the bedrock is exposed or covered by a thin layer of lichen and moss. The terrain is dominated by forested till and marsh.

For this hypothetical example a simple geological model was generated in the statistical software T-PROGS (part of the computer program GMS from Aquaveo). The simulations are kindly made available by Miriam Zetterlund (Zetterlund, 2009). For more details about the simulations see Zetterlund (2009). The realization of the possible rock volume (example shown in figure 3):

- Each cell is 1x2x2 metre (i.e. 80x100x100 metre)
- The virtual tunnel will be constructed in the central cells (3x3 cells)
- Two rock classes, good rock (RC1) and poor rock (RC2)
- Problematic rock are fracture zones and clay weathered rock (poor rock)
- Good rock is unaltered
- 10 % poor rock (red)

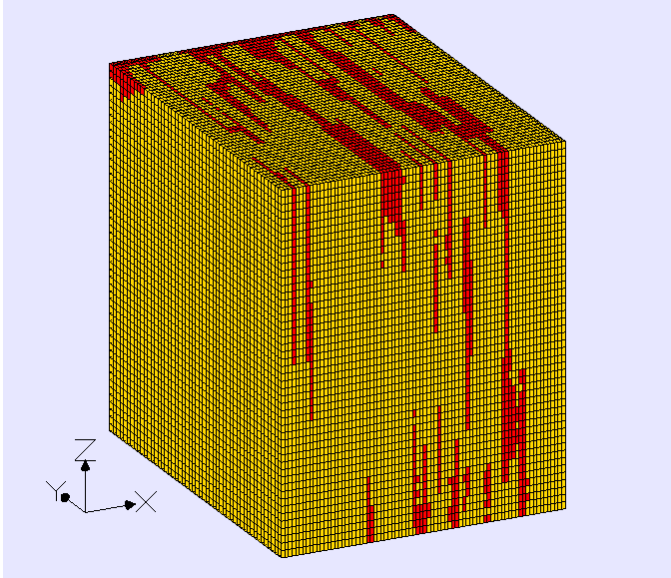

Figure 3. An example of a 3D simulation. Modified from Zetterlund (2009)

In the software it is possible to create 2D slices in both horizontal and vertical direction in order to evaluate the rock properties through the whole rock volume. In total 200 3D simulations (example shown in figure 3) were generated.

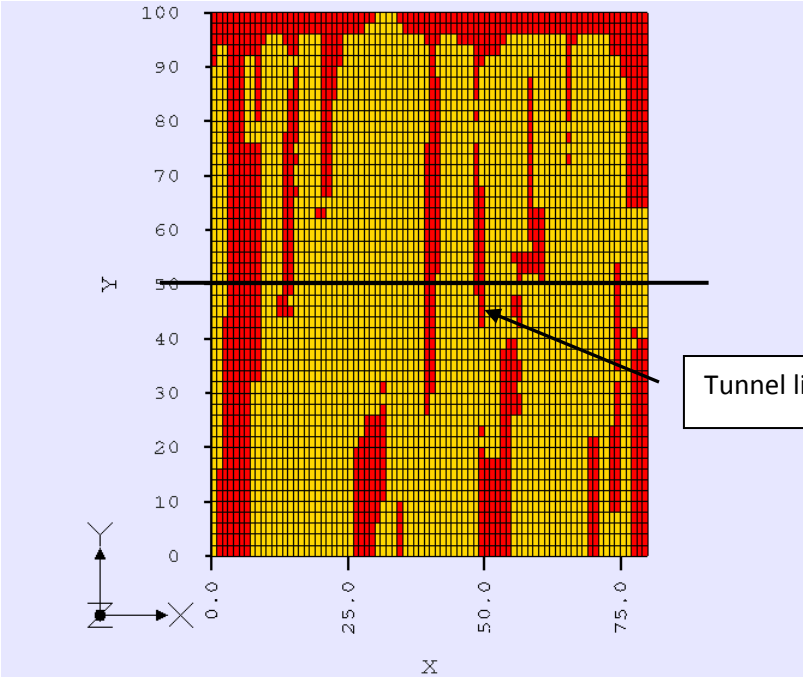

Figure 4. Example of a 2D surface view with the tunnel line marked.

Estimation of probabilities

It is difficult to obtain an un-biased estimation of the value of geophysics because the concept of the methods can vary from expert to expert and accordingly geophysics is not easily amenable to mathematical representation. Nevertheless the probability that geophysics detects failure is essential to this VOIA. In an attempt to make the used probability more reliable seven experts were asked

their opinion of how good a geophysical method is in the geological environment of the hypothetical example. The experts have all worked with the application of geophysical methods in hard rock environment in national and/or international tunnel projects. The experts were asked to give their opinion based on 10 randomly chosen simulations of possible rock volumes (described in previous chapter). The experts should base their judgement on the information from the geology description and on “outcrops” (surface view) on the surface of the simulations (Fig. 4). In this way the information available resembles how it would be in an actual case.

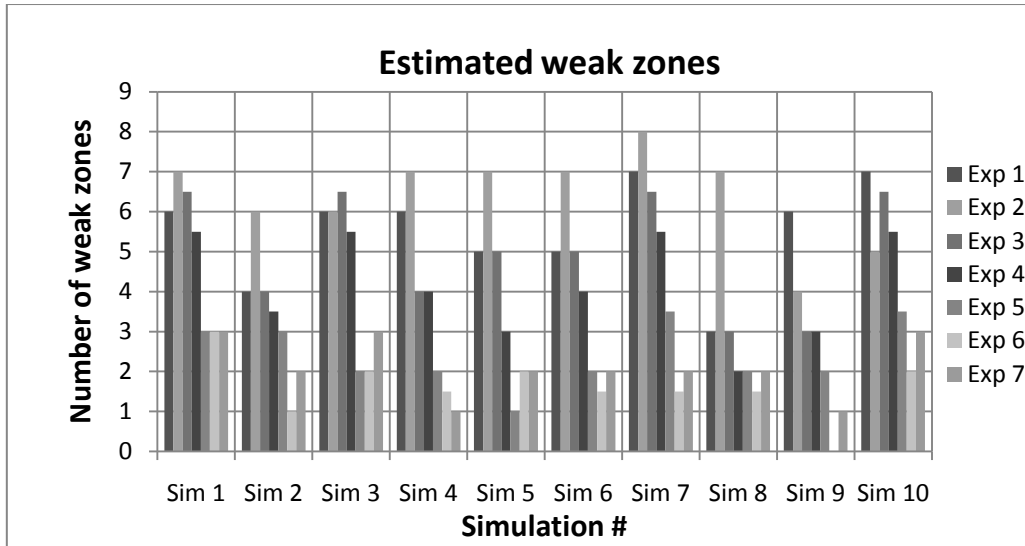

Figure 5. The expert’s judgement of the number of weak zones in the 10 randomly chosen simulations of possible rock volumes.

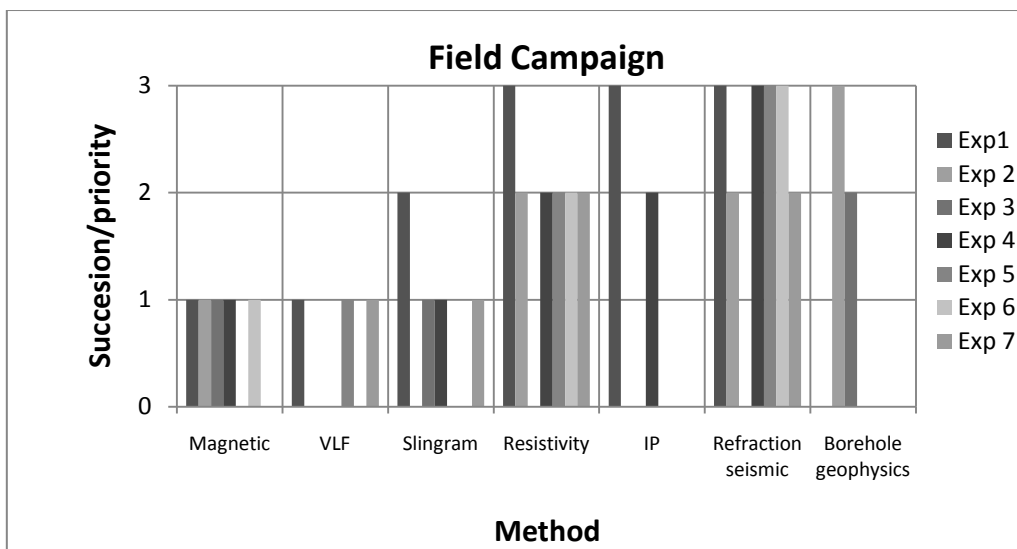

Figure 6. The expert’s opinion about which geophysical methods to use and the succession with which the methods should be used. NB. Not all methods were mentioned by every expert.

The experts were also asked to suggest which methods to use and how they would plan the pre-investigations. In figure 5 the experts judgment of the number of weak zones in the 10 randomly chosen simulations are plotted. There is a large difference in the number of zones even though it is the same simulations the experts were presented to. This has to be seen in relation to the experts

different proposals to possible field campaigns, figure 6. However the experts agree on that the first priority is to use a fast and qualitative method e.g. magnetometer, VLF or Slingram. In the second stage a more quantitative method such as geoelectrical imaging or refraction seismic is preferred. Only 2 of the 7 experts suggest borehole geophysics. This might be due to the relatively limited access to logging equipments in Sweden. Despite the difference between the numbers of weak zones the experts estimate, there is a consistency in how each expert evaluates the probability for the geophysical methods to detect the weak zones. The experts can be divided in two groups, where expert 1–4 generally is more optimistic than expert 5–7. Despite the fact that there is a difference between the opinions of the two groups their answers are useful for the estimation of the probability that geophysics detects failure. Their answers should be seen as a guideline in the estimation of the probability.

Table 1. The probability of detecting weak zones/dolerites using different geophysical methods. The size of the object has importance for the probability. Based on Danielsen (2010), Danielsen and Dahlin (2009), Stanfors (1987) and Rønning (2003).

Method	Anomaly	Size	Probability
Aeromagnetic	Weak zone	>50 m	80%
		<50 m	25%
Ground magnetic 10–20 m accuracy	Dolerite (Scania)	>10 m	85%
		>50 m	80%
VLF	Weak zone	>50 m	75%
		<50 m	60%
Slingram	Weak zone	>50 m	85%
		10–50 m	60%
Seismic refraction	Weak zone	>50 m	31%
Resistivity	Weak zone	>50 m	95%
		<10 m	80%

As part of the evaluation of the geophysical methods, the experience from geophysics in other tunnel projects is used (table 1), so that not only the experts opinion is considered when estimating the probability. The authors experience from Hallandsås Tunnel (Danielsen, 2010; Danielsen and Dahlin, 2009) and Bolmen Tunnel (Stanfors, 1987) both in southern Sweden, are used together with work done by NGU in Norway (Rønning, 2003). The geological setting in the examples is different but still it is possible to obtain an impression of the probability of finding a weak zone using the different geophysical methods.

Pre-investigation program

Based on the experience gained from interviewing the experts and from evaluating the results from other tunnel project a pre-investigation program is planned. The pre-investigation is performed top-down meaning that the investigation is progressing from large to small scale. The program is divided in two parts where the first is:

1. Archive study
2. Field visit incl. fracture count if possible
3. Magnetics (5 parallel lines)
4. CVES (resistivity/IP) (1 line along tunnel line, c/c 5 metre)

The pre-investigation should start with an archive study where existing material is evaluated. This includes geological maps, existing boreholes and other types of geological data. Based on this a field visit should be done where possible exposed rock surface is inspected. If the rock surface is visible a fracture count should be performed. Next step is to make magnetic measurements, which is a fast qualitative method. Five parallel lines should be measured along the tunnel line. This is followed by CVES measurements. One profile line should be done parallel to the tunnel line (c/c 5 metre). A first interpretation of the geophysical data is based on the information from the archive study as a priori data.

When data are evaluated it might be necessary to make additional CVES and/or refraction seismic measurements in selected (problematic/ambiguous) areas. Thus the second part consists of:

5. (Additional CVES at problematic/ambiguous areas)
6. (Refraction seismic (1 line along tunnel line, c/c 5 metre))
7. Earth/rock soundings (consistent distance)
8. 1 core drilling and 1-3 percussion drilled holes
9. Geophysical logging in the boreholes
10. Pumping tests/flow tests
11. Laboratory/rock mechanical tests

During the pre-investigation the results of each step should be evaluated before continuing to the next step. An engineering geological prognosis should be compiled based on all information.

Framework

In the following a framework is presented where the value of geophysical measurement in pre-investigation for rock tunnel construction is evaluated. The geophysical methods are geoelectrical imaging and ground based magnetic measurements. The suggested pre-investigation program is discussed further in paper 6. In this framework a responsible authority (e.g. Trafikverket) plans to build a tunnel and orders a pre-investigation from a consultant (Fig. 7). The first step for the consultant is to produce an early (rough) engineering geological prognosis (based on archive data and field visits). The consultant has to decide what the major concerns are and how to proceed with the pre-investigations. Should a detailed prognosis be done or is the early prognosis enough as basis for contract negotiation? If a detailed prognosis is made, should it then consist only of drillings or also geophysics? These question marks are answered by VOIA. When the basis for contract negotiation is ready the contractors can start giving offers on the work.

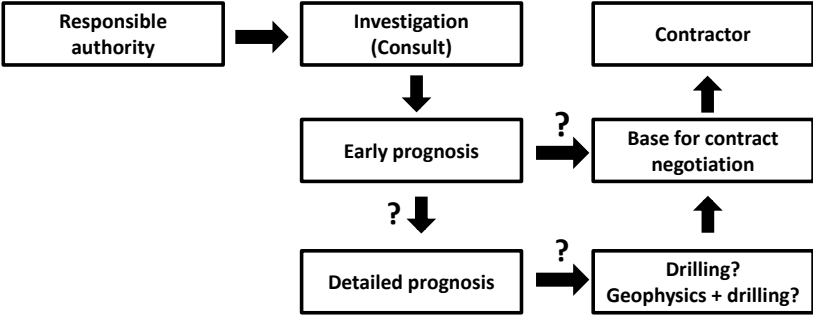

Figure 7. The flow in the decision process for a construction work. The question marks are answered by VOIA.

In the VOIA there are different decision alternatives (Fig. 8). In the prior analysis it has to be decided which of the construction alternatives to use. The first alternative is to assume that 10% of the rock is poor (reference alternative). This means that when constructing the tunnel reinforcement class BFK3b is used in 10% of the tunnel length. For a description of the reinforcement classes see appendix B. In alternative two it is assumed that 40% of the rock is poor and requires reinforcement with BFK3b. Thus the construction is more expensive. In the preposterior analysis it has to be decided which of the pre-investigation programs to use: 1) two core drillings or 2) geoelectrical imaging, ground based magnetic (in the following called geophysics) and two core drillings positioned based on the geophysics.

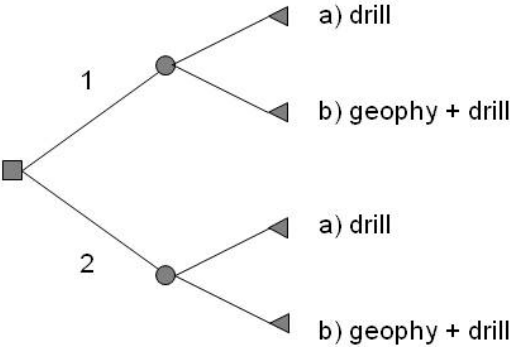

Figure 8. Decision tree for the problem in this VOIA. Squares are decision nodes, circles are chance nodes and triangles are terminal nodes. First decision (prior analysis) is regarding construction alternatives: 1 is standard and 2 is extensive. Second decision (preposterior analysis) is regarding pre-investigation alternatives: a) drillings or b) geophysics combined with drillings.

The probabilities necessary for the cost-benefit analysis are based on 10 simulations (different from those evaluated by the seven experts). It is decided that failure is when there is weak rock (RC2) at tunnel level.

The approach for estimation of probabilities:

1. The 10 simulations are divided into 10 sections, each 8 metre long. Only a 6 metre wide zone in the y-direction was considered which resembles the width of the tunnel (Fig. 9). It is assumed that only the excavated rock volume is important. Each section is therefore 8x3 cells in the 2D view.

2. For the *prior analysis* the 2D surface view ($z = 0$) is used to calculate the first $P(F)$ for 10x10 sections. For the calculation of $P(F)$ it is counted in how many of the sections the surface view (regarded as engineering geological prognosis) shows RC2 (failure). It is assumed that there has to be more than one cell (pixel) showing RC2 for the section to be considered as failure.
3. For the *preposterior analysis* the probability of detecting failure, $P(D | F)$, and not detecting failure, $P(D' | F')$, for each of the 10 sections (in each of the 10 simulations) should be calculated taken the information from pre-investigation into account (two different pre-investigation approaches). Based on the simulations it is estimated if the weak rock type is detected by the pre-investigation and an engineering geological prognosis is compiled. It is evaluated in how many sections the engineering geological prognosis detects RC2 (at tunnel level, $z = 50$).

The estimated probabilities are:

$P(D | F)$: probability for detecting weak rock (RC2) that exist

$P(D' | F)$: probability for *not* detecting weak rock (RC2) that exist

$P(D | F')$: probability for detecting weak rock (RC2) that *not* exist

$P(D' | F')$: probability for *not* detecting weak rock (RC2) that *not* exist, this is equivalent to detecting good rock (RC1).

4. Calculate the preposterior value of the tunnel in each decision alternative using Bayes' formula.

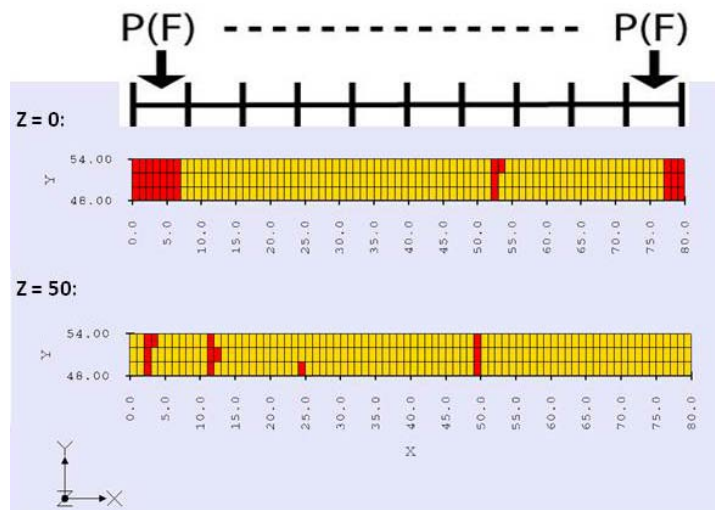

Figure 9. 2D surface ($z = 0$) and tunnel ($z = 50$) view used for estimating the probability for failure, $P(F)$.

Prior analysis

In the prior analysis it has to be decided which construction alternative to use, standard or extensive. In the standard approach the cost for the construction is lower than in the more extensive approach. The input data and results are given in table 2 and 3 and the calculations in the prior analysis are shown in appendix B. The probability of failure is calculated using the simulations as described in step 2. It turned out that $P(F)$ is 0.5 and thus $P(F')$ is also 0.5. This is so even if there in the T-PROGS simulation only is 10% RC2. However it has to be acknowledged that the sections are regarded as poor if more than 1 pixel in each section is RC2. It is assumed that in the construction of the tunnel it

is not possible to switch reinforcement class for each metre, so there has to be a *reaction length*, which is said to be a full section.

Table 2. The input data for the prior analysis.

Cost		kSEK
Cost of tunnel (alternative 1)	C_1	10085
Cost of tunnel (alternative 2)	C_2	14389
Difference	$C_i = C_2 - C_1$	4304
Probability		
Probability for RC2	$P(F)$	0.5
Probability for RC1	$P(F')$	0.5

Table 3. The calculated output data from the prior analysis.

Alternative 1		kSEK
Cost of tunnel	C_1	0
Cost of failure	C_{F1}	110160
Risk cost	R_1	6885
Benefit	B_1	0
Alternative 2		
Cost of tunnel	$C_i = C_2 - C_1$	4304
Cost of failure	C_{F2}	96390
Risk cost	R_2	1721
Benefit	B_2	5164
Objective functions		
C_{switch}	$C_{F1} - C_{F2}$	13770
Value of alternative 1	ϕ_{1prior}	0
Value of alternative 2	ϕ_{2prior}	860
Value of prior analysis	ϕ_{prior}	860

If the unexpected occurs the construction cost might increase because of the increased amount of materials needed (e.g. shotcrete + bolts) but more importantly due to the increase in construction time. In Malmtorp and Lundman (2010) and Kim and Bruland (2009) it is estimated that it takes 50% longer time to construct a tunnel if e.g. BFK3 is used instead of BFK1. Therefore it is assumed here that the cost is 50% higher when the change from one strategy to another is unexpected. This additional cost if the unexpected happens (C_F , failure) is calculated for each alternative. The probability, $P(F)$, that something unexpected happens was 0.5 and when the strategy is to only use the extensive reinforcement in 10 out of 100 sections the project is unprepared in 40 out of 100 sections. In alternative 2 the project is only unprepared in 10 out of 100 sections. The difference between the cost of failure in the two alternatives is called the switchover cost, C_{switch} , and is the cost for the additional time needed because the project is unprepared for the required reinforcement. The failure cost is lowest in alternative 2 and thus the $C_{switch} = C_{F1} - C_{F2} = 13770$ kSEK. 1 kSEK is 105 euro (September 2010).

The risk in alternative 1 is that the construction strategy has to be changed if something unexpected happens. The risk is calculated as: $R_1 = P(F) C_{switch}$. For alternative 2 the risk is $R_2 = R_1/4$, because the project only is unprepared in 10/100 sections and not 40/100 sections.

In the first alternative with the standard approach the benefit is zero whereas the benefit of using the extensive and more expensive approach is a lower risk for something unexpected to happen: $B_2 = R_1 - R_2$. In other words the benefit is what is saved if the project is prepared for change in reinforcement strategies.

In the prior analysis the prior objective function is calculated for both alternatives using equation 2, i.e. $\phi_i = B_i - C_i$, and is the expected net benefit with present information. The best alternative is the one with the highest value for the project. The value of the prior analysis is calculated as $\phi_{prior} = \max(\phi_{1prior}, \phi_{2prior}) = \max(0, 860 \text{ kSEK}) = 860 \text{ kSEK}$. Therefore the alternative 2 with the extensive construction approach is the best decision.

Preposterior analysis

In the preposterior analysis the value of a pre-investigation is calculated before the measurements are done and is therefore the expected net benefit with information from the planned sampling program. It has to be decided if the best alternative is to only do drillings or if the best alternative is to do geophysics prior to drillings. The probability for detecting failure using geophysics or no geophysics is estimated as described in step 3. The input data for the preposterior analysis are given in table 4. Calculations can be seen in appendix B.

Table 4. The input data for the preposterior analysis.

		Only boreholes	Geophysics and boreholes	EVPI
Probability for RC2	P(F)	0.50	0.50	0.50
Probability to detect RC2	P(D F)	0.40	0.68	1
Probability to detect RC2 that not exist	P(D F')	0.27	0.03	0

Table 5. The results from the preposterior analysis.

		Only boreholes	Geophysics and boreholes	EVPI
Conditional probability	P(F D)	0.60	0.95	1
Conditional probability	P(F D')	0.45	0.25	0
Probability of detection	P(D)	0.33	0.35	0.50
		kSEK	kSEK	kSEK
Preposterior value	$\phi_{prepost}$	2581	3123	4733
Expected value	EVI	1721	2253	3873
Exp. Net value	ENV	1441	1863	

The preposterior value, $\phi_{prepost}$, for both alternatives is calculated using equation 3:

$$\phi_{prepost} = \max(0, C_{switch}P(F | D') - C_i)P(D') + \max(0, C_{switch}P(F | D) - C_i)P(D)$$

The conditional probabilities used in the preposterior analysis is calculated using Bayes' theorem (Eq. 4) and $P(D)$ from the law of probability (Eq. 5). The results are summarised in table 5.

The preposterior value, ϕ_{prepost} , of only drilling boreholes in the pre-investigation is 2581 kSEK, whereas the value of a combination of geophysics and a borehole is 3123 kSEK. And therefore geophysics combined with a borehole is the best alternative. In the calculation of the preposterior value in appendix B it is seen that the value of not achieving data (D') is zero whereas the value of achieving the data (D) is 8777 kSEK.

Value of perfect information

Calculating the EVPI means that the probabilities $P(D' | F)$ and $P(D | F')$ both are zero and perfect information is obtained. The EVI for the perfect information (EVPI) is 3873 kSEK. This is regardless of which alternative is chosen for the pre-investigations.

Expected value and expected net value

The expected value EVI, that is the value of new information, is calculated $EVI = \phi_{\text{prepost}} - \phi_{\text{prior}}$ (Eq. 6). For the project the information has a value or worth even though there is a cost combined with the decision. For using geophysics the EVI is 2253 kSEK. The EVI for only drilling boreholes is 1721 kSEK and therefore this alternative has a lower value for the project. If the cost for the pre-investigation should be considered the expected net value for geophysics, ENV is calculated to 1863 kSEK using equation 7. However the pre-investigation program should in the best case also contain geophysical borehole logging and pumping tests. But in the ENV only the methods considered here are used in the calculations.

Sensitivity analysis

An essential part of this VOIA is the sensitivity analysis of the different input variables. For the analysis of the different variable's uncertainty a Monte Carlo simulation is made where a large number of random solutions ("qualified guesses") are calculated. In this case 10^5 simulations were done. The parameters are systematically changes to determine the effects of such changes. In this way the robustness of the study is investigated. Monte Carlo uses statistical distributions to represent different kinds of uncertainty and for the analysis a probability density function (pdf) has to be chosen for each of the stochastic variables (Burgman, 2005). This is a difficult part and in this case a beta-distribution is applied. For the pdf's the mean and standard variation is calculated.

Table 6. Input data to the Monte Carlo simulations (costs in kSEK).

		Mean	Standard deviation
Cost if failure (alternative 1)	C_{F1}	110160	1840
Cost if failure (alternative 2)	C_{F2}	96390	460

Table 7. The parameters for the beta-distributions.

		α	β
Probability for RC2	P(F)	51	51
Alternative 1 (only boreholes)			
Probability to detect C2	P(D F)	17	25
Probability to detect RC2 that not exists	P(D F')	17	45
Alternative 2 (geophys + bh)			
Probability to detect C2	P(D F)	28	14
Probability to detect RC2 that not exists	P(D F')	3	59

In this analysis the only cost-variables to consider is the cost of failure, C_{F2} and C_{F2} . The other costs in the calculations depend on these two variables and therefore it is not reasonable to analyse any other. It is assumed that the two costs are normal distributed and that they to some extent are dependent on each other and therefore the correlation is said to be 0.6. The probabilities P(F), P(D | F) and P(D | F') are said to be beta-distributed in all alternatives. The input data for the simulations are seen in table 6. For the probabilities it was chosen to use a beta distribution, table 7.

In 13.4% of the 10^6 simulations construction alternative 1 was the best solution in the prior analysis. In the remaining 86.6% of the simulations alternative 2 was the best solution. For the preposterior analysis the results of the simulations can be seen in table 8. The mean value of only drillings is 1683 kSEK and the standard deviation is 351 kSEK. For the combination of geophysics and drillings the mean value is 2218 kSEK and standard deviation is 312. In only 13 of the 96634 simulations (with EVI > 0) the solution with only drillings is the best alternative.

Table 8. The results from the simulations of the preposterior analysis.

		Only boreholes	Geophysics and boreholes	EVPI
Expected value > 0	EVI > 0	~100%	100%	~100%
		kSEK	kSEK	kSEK
Mean value (given that EVI > 0)		1683	2218	3826
Standard deviation		351	312	301
Exp. Net value	ENV	1403	1828	

Discussion

In the prior analysis conducted in this example it was seen that the extensive construction approach is the best alternative. The value of the standard approach is zero and the value of the extensive is 860 kSEK and therefore the latter is the best alternative because the prior function (Eq. 2) is maximised. The sensitivity analysis showed that the standard approach is the best solution in 13.4% of the 10^5 simulations. It is notable that the best alternative is to assume that it is necessary to use BFK3 instead of BFK1 in 40% of the tunnel, even though in this simulation only 10% of the rock is classified as poor rock (RC2). The reason is probably that it is assumed that in the construction of the

tunnel it is not possible to switch reinforcement class for each metre and therefore a larger ratio of the volume is regarded as RC2.

The preposterior analysis showed that the highest value is obtained by using a combination of ground based magnetic measurements, geoelectrical imaging and core drillings as base for compiling an engineering geological prognosis. The expected value of new information (EVI) is approximately 2250 kSEK which should be seen in relation to a total construction cost of 104800 kSEK. The expected value of using the information from only core drillings is approximately 1700 kSEK. However there are uncertainties in the calculations from both the probabilities and the cost. In an attempt to reduce the uncertainty seven experts were asked their opinions. Nevertheless an un-biased estimation of the value of geophysics is still difficult to obtain because the confidence in the methods can vary from expert to expert. What also has to be considered regarding the experts is that they have different ideas about how a pre-investigation campaign should be planned. All of this was considered when a combination of the experts opinions, the experience from geophysics used in other tunnel projects and the authors experience from the use of the geoelectrical method when the probabilities for the specific project were estimated. However the probabilities used in the example are calculated based on 10 simulations, which means they are rather uncertain in statistical terms. A sensitivity analysis is therefore conducted to support the results. Even though the framework originates from a real tunnel case it has been a challenge to estimate the cost if failure occurs (switchover cost) because such a cost is first negotiated if delay occurs and/or increased material expenses exceeds the budget. Consequently the question is very complex and beyond the scope of this framework. The main focus is the value of pre-investigation and not contractual problems. Here a switchover factor based on literature examples (Malmtorp and Lundman, 2010); Kim and Bruland, 2009) is estimated and used in the calculations.

The sensitivity analysis showed that in nearly 100% of the simulations it would have a value to perform only core drillings. However the analysis also showed that the alternative with only drillings had the highest ENV in only 13 of the 96634 simulations where ENV was positive. Otherwise alternative 2 including geophysics have the highest ENV. The chance/risk that the highest data value is obtained with performing only drillings is therefore minimal. However it should be taken into consideration that the drillings in this case only has the purpose to detect RC1 or RC2 based on what is seen at the surface. The drilling gives point information and might miss a weak zone nearby. In reality a core drilling is also used for e.g. laboratory tests, and therefore has a value for a project in that sense, but this value is not taken into account in the analysis. Nevertheless the difference in EVI between the two decision alternatives is relatively large and therefore implies that it can be strongly recommended for the decision-makers to perform a profound pre-investigation including geophysics (in this case ground based magnetic measurements and geoelectrical imaging) as guideline for where to do the drillings.

The value of perfect information (EVPI) is 3873 kSEK and can be considered as the maximum cost for the investigations to be worthwhile to perform. However perfect information is hypothetical and in a construction project it is impossible to obtain so much information that the risk for something unexpected to happen is zero. The sensitivity analysis of the EVPI ($EVI > 0$) gives a mean value of 3826 kSEK with a standard deviation on 301 kSEK. Thus it can be concluded that not even geophysics and boreholes gives perfect information. As for the alternative with only boreholes the geophysical data can also have additional value in a later project phase that not is considered here.

The benefit of having the most certain engineering geological prognosis is less risk and a more predictable cost. The benefit should be seen as the amount of money saved when the best decision is made. The benefit depends very much on the rock mass properties because the costs increase dramatically when rock quality decreases. Generally the benefit should be seen in proportion to direct cost (everything which can be measured and calculated), indirect cost (cost which come in play when anything unexpected happens, i.e. switchover costs) and absent cost (what does not happen but what society loses if a project is not finished. E.g. what does society lose if a railroad station is not finished in time).

The example used is a relatively simple case with a 800 metre long tunnel constructed using drill and blast. Even with a fairly moderate budget and time schedule it is still worthwhile to perform the more profound pre-investigation. With a 50% higher costs for a strategy change by unexpected geological conditions, the extra cost for the geophysics will soon be meaningful to take. For a major tunnel project with more complex geological settings the costs if something unexpected happens might even be much higher. If the deviation from the anticipated rock conditions is severe the tunnel construction can be influenced due to shorter blasting rounds and/or construction of a pilot tunnel. It might even be necessary to use a heavier reinforcement class. Thus an extra cost could be significant e.g. size of tunnel may be too small if more support is required, extra monitoring may be needed; and mobilization of equipment could be required. But most important, it will take longer time and this will imply extra cost. A worst case scenario could be if the work has to be stopped or an incorrect construction approach is used. This would naturally make the cost if failure even higher than the 50% assumed in the example.

The rock volume simulations generated with T-PROGS in GMS is a useful tool for estimating the probabilities, but requires a rather extensive knowledge of how different anomalies would appear in the geophysical data. If experience with a certain geophysical method is deficient, a natural foundation would be numerical modelling where it can be tested how a specific geological setting would appear in the geophysical data. An example of this is given in Danielsen and Dahlin (2008) where numerical modelling is used for identifying the response from a dolerite dyke using geoelectrical and induced polarization measurements. By using the T-PROGS simulations it is important to acknowledge that the rock volume simulations are randomly generated and might not always reproduce a realistic geological environment.

The geological model and the problems considered in this VOIA are a simplification of reality. The model can be further developed and become more complex. However this VOIA is meant as a demonstration of the general idea behind VOIA and the considerations behind the framework are generally valid when geophysics is evaluated.

The aim with this VOIA was to show that it is important to use a suitable geophysical method prior to drilling; however there will always remain some uncertainties in the engineering geological prognosis no matter how many measurements are made. But with the VOIA the value of new information from ground based magnetic measurements and geoelectrical imaging is assessed by estimating the reliability in the present information compared to the expected increase in reliability following collection of new information. New information is only interesting when it can change the outcome of the decision and thus is of value for the decision-maker. The cost of an investigation or measurement should be less than what is expected to be saved; otherwise the investigation should

not be made (Back, 2006; Bedford and Cooke, 2001; Freeze et al., 1992). Applying these lines of thoughts to geophysics gives the decision-maker the opportunity to evaluate the reliability in an approach without actually being an expert in either VOIA or geophysics. A cost-benefit analysis shows in clear terms if it is worthwhile to incur the cost of additional measurements or not. VOIA is a model of reality and is therefore also encumbered with uncertainty, but a sensitivity analysis gives a clear idea of the reliability. Also by looking at the *success* probabilities $P(D|F)$ and $P(D'|F')$ an impression of the reliability of the investigation is obtained. In this particular case the alternative 1 (only drillings) has a $P(D|F) = 0.40$ and $P(D'|F') = 0.73$ whereas alternative 2 (geophysics and drillings) has a $P(D|F) = 0.68$ and $P(D'|F') = 0.97$. Thus the second alternative has a higher reliability regarding differentiation between good and poor rock quality. However for the alternative to be worthwhile to choose the risk reduction has to be sufficiently large.

VOIA is an aid for decision-makers to evaluate the value of different alternatives before taking action and is therefore in this case an attempt to show the value of geophysics by using an approach the decision-makers understand. The framework developed here has the potential to become an integral part of pre-investigation. The analysis should be done after the archive study and prior to the first geophysical measurements. In many construction projects some kind of geophysical method is used e.g. refraction seismic, but this is not always the case. In some projects it might be very beneficial to use another or additional geophysical method, e.g. geoelectrical imaging, seismic, magnetic or a combination. VOIA can help evaluate and design the best measurement program for a specific geological setting. The challenging part is to assign the most certain probabilities. An important issue with a VOIA is that it is constructed specifically for every problem and cannot be re-used from project to project. The cost-benefit calculations are relatively simple to perform; however with the framework developed it is straightforward to change the costs and probabilities in the calculations.

Conclusions

The framework for a VOIA of geophysical methods used in pre-investigation showed that the value of performing ground based magnetic measurements and geoelectrical imaging prior to drillings has a higher value than make drillings without using geophysics. This result is only valid for this particular geological setting and is site specific. Nevertheless the framework is applicable to all projects where geophysics used in pre-investigation should be evaluated. The analysis should be done after the archive study and prior to the first geophysical measurements. It can help designing the best measurement program for a specific geological setting if the task is to decide between different geophysical methods, e.g. geoelectrical imaging, seismic, magnetic or a combination. The framework developed here has the potential to become an integrated part of a pre-investigation.

Acknowledgements

This work was financed by Rock Engineering Research Foundation (BeFo) and Swedish Construction Industry (SBUF). Special thanks go to Miriam Zetterlund, Chalmers University of Technology, Sweden for supplying the T-PROGS simulations.

References

- Andersson, J., Munier, R., Ström, A., Söderbäck, B., Almén, K.-E., and Olsson, L., 2004, *When is there sufficient information from the Site Investigations?*, Stockholm, Sweden, Swedish Nuclear Fuel and Waste Management Company (Svensk Kärnbränslehantering AB), R-04-23.
- Back, P.E., 2006, *Value of information analysis for site investigations in remediation projects* [Ph.D. Thesis]. Department of Civil and Environmental Engineering, Division of GeoEngineering, Chalmers University of Technology, Göteborg, Sweden.
- Back, P.E., 2007, A model for estimating the value of sampling programs and the optimal number of samples for contaminated soil. *Environmental Geology*, v. 52, p. 573-585.
- Baecher, G.B. and Christian, J.T., 2003, *Reliability and statistics in geotechnical engineering*. John Wiley & Sons Ltd.
- Bedford, T. and Cooke, R., 2001, *Probabilistic Risk Analysis: Foundations and methods*. Cambridge University Press.
- Buland, A., Løseth, L.O., and Røsten, T., 2010, The Value of CSEM Data in Exploration, *Conference proceeding. 72nd EAGE Conference & Exhibition incorporation SPE EUROPEC 2010, Barcelona, Spain*.
- Burgman, M., 2005, *Risks and decisions for conservation and environmental management*. Cambridge University Press.
- Danielsen, B.E., 2007, *The applicability of geoelectrical imaging as a tool for construction in rock*. [Licentiate Thesis]. Engineering Geology, Lund University.
- Danielsen, B.E., 2010, *The applicability of geoelectrical methods in pre-investigation or construction in rock* [Ph.D. Thesis]. Engineering Geology, Lund University.
- Danielsen, B.E. and Dahlin, T., 2008, Numerical modelling for improvement of the interpretation of geoelectrical and induced polarization measurements, *Conference proceeding. 14th European Meeting of Environmental and Engineering Geophysics, Krakow, Poland*.
- Danielsen, B.E. and Dahlin, T., 2009, Comparison of geoelectrical imaging and tunnel documentation at the Hallandsås Tunnel, Sweden. *Engineering Geology*, v. 107, p. 118-129.
- Davis, J.C., 2002, *Statistics and data analysis in geology*. John Wiley & Sons, Inc.
- Eidsvik, J., Bhattacharjya, D., and Mukerji, T., 2008, Value of information of seismic amplitude and CSEM resistivity. *Geophysics*, v. 73, p. R59-R69.
- Freeze, R.A., James, B., Massmann, J., Sperling, T., and Smith, L., 1992, Hydrogeological Decision Analysis: 4. The Concept of Data Worth and Its Use in the Development of Site Investigation Strategies. *Ground Water*, v. 30, p. 574-588.
- Kim, Y. and Bruland, A., 2009, Effect of rock mass quality on construction time in a road tunnel. *Tunnelling and Underground Space Technology*, v. 24, p. 584-591.
- Malmtorp, J. and Lundman, P., 2010, *Förundersökningar vid undermarksprojekt - Osäkerheter och deras hantering*, Trafikverket, p. 3-82. (In Swedish).

Norberg, T. and Rosén, L., 2006, Calculating the optimal number of contaminant samples by means of data worth analysis. *Environmetrics*, v. 17, p. 705-719.

Olofsson, P., 2005, *Probability, statistics, and stochastic processes*. John Wiley & Sons, Inc.

Rønning, J.S., 2003, *Miljø- og samfunnstjenlige tunneler. Sluttrapport delprosjekt A, Forundersøkelser*, NGU, Report nr. 2003.007. (In Norwegian).

Stanfors, R., 1987, *The Bolmen tunnel project. Evaluation of geophysical site investigation methods*, Stockholm, In SKB (Swedish Nuclear Fuel and Waste Management Company), ed., Stockholm, Technical Report 87-25.

Sturk, R., 1998, *Engineering Geological Information - Its Value and Impact on Tunnelling* [Ph.D. Thesis]. Division of Soil and Rock Mechanics, Department of Civil and Environmental Engineering.

Zetterlund, M., 2009, *Geological Characterisation and the Observational Method Application of Value of Information Analysis* [Licentiate Thesis]. Department of Civil and Environmental Engineering. Chalmers University of Technology, Göteborg, Sweden.

Appendix A

Background to the questionnaire

Outline

- Value of information analysis (VOIA) and geophysics
- Geophysical measurements
- Tunnel project
- Geology
- Model
- References

Value of information analysis (VOIA) and geophysics

A major problem when constructing tunnels is unforeseen rock conditions e.g. water leakage and changes in rock mechanical properties. The contractor needs as much information about the ground conditions as possible in order to provide a sound financial offer, prepare adequate equipment and to organize a relevant contingency plan. An unforeseen event can delay the project with further costs as a consequence. To reduce the uncertainty an engineering geological prognosis is necessary. This prognosis should be based on geophysical measurements supported by drillings (Danielsen, 2007).

The results of the geophysical measurements usually have to be processed and evaluated by a geophysicist. Only the geophysicist knows the sensitivity and resolution of the methods. Thus the engineer does not always have appropriate expectations of the advantages and limitations of the geophysical methods. On the other hand the geophysicist does not always have detailed understanding of what the engineer requires; e.g. at what scale is information needed? One task for the engineer and the geophysicist is to find a common language (Danielsen, 2007). Value of information analysis (VOIA) might be an approach for communicating with the decision-makers.

VOIA has become a central part in decision-making in complex problems. It can help to create a rational design strategy for investigation programmes. The method is based on Bayesian statistics and cost-benefit analysis and is suitable for problems where different alternatives are evaluated and compared, e.g. the design of an investigation programme when the number of measurements or investigations needs to be determined. In VOIA the cost and the time it takes to obtain better information must be compared to what can be saved by not doing anything¹. New information is only interesting when it can change the outcome of the decision, and thus is of value for the decision-maker. The cost of an investigation or making a measurement should be less than what is expected to be saved; otherwise the investigation should not be made (Bedford and Cooke, 2001; Freeze et al., 1992; Zetterlund 2009).

¹ In VOIA the value of new information, from measurements for example, is assessed by estimating the uncertainties in the present information. This value is then compared to the expected reduction in uncertainty following collection of new information. The cost and the time it takes to obtain better information must be compared to what can be saved by modifying the investigation programme.

To our knowledge the VOIA approach has never been applied to geophysical methods used in pre-investigations. One of the central tasks is to evaluate how good different geophysical methods are at detecting problematic rock conditions in otherwise good rock. Because, such an estimation can be biased (based on experience, affection by a person etc.), our approach is to ask geophysical experts to judge this in order to get a more objective result. The experts will be presented to a number of simulations of possible rock volumes and the estimate should be based on those. The experts opinion is then the foundation for the probability used in the VOIA. It is also important to remember that the estimate is only valid for a specific geological setting which will be described further down. The example is hypothetical but is inspired by an actual tunnel construction in Sweden.

Geophysical measurements

The idea is that the geophysical measurements (hypothetically) are preformed as a part of the pre-investigation in an early project phase. The measurement setup can differ depending on what the expert would recommend. The setup should be realistic for a pre-investigation. The expert should base their judgement on the information from the geology section and on “outcrops” (surface view) on the surface of the Simulations (Fig. 1). In this way the information available resembles how it would be in an actual case.

Tunnel project

Facts about the tunnel:

- Railroad tunnel
- 800 metre long
- 25-30 metre below surface
- 6x6 m²
- Drill and blast
- 5 types of reinforcements

Geology

The geological setting in the area is dominated by greywacke and granite. There are elongated sections with pegmatite and dolerite dykes. The valleys that are found on both sides of the tunnel coincide with regional fracture zones with a size that varies between 10 and 20 metre. The soil deposits are relatively thin and in some areas the bedrock is exposed or covered by a thin layer of moss. The terrain is dominated by forested till and swamp areas.

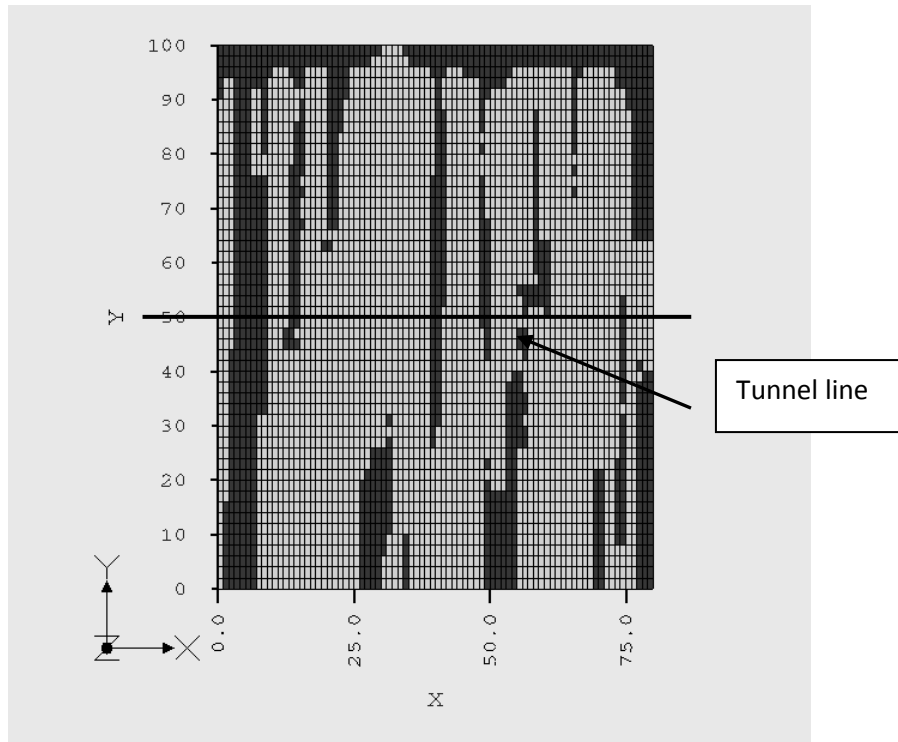

Fig. 1. Example of a 2D surface view with the tunnel line marked.

The Model

The simulation of the possible rock volume (Example shown in figure 2)

- 80x50x50 cells
- Each cell is 1x2x2 metre (i.e. 80 metre long)
- The virtual tunnel will be constructed in the central cells (3x3 cells) (See fig. 3)
- Two rock classes
- Problematic rock are fracture zones and clay weathered rock (poor rock)
- Good rock is unaltered
- 10 % poor rock (black)

The simulations are generated in the software GMS. In total 200 3D simulations are generated but only 10 (randomly chosen) will be presented. The simulations are shown as 2D views seen from the surface. In every 10 simulations the tunnel line is marked for orientation.

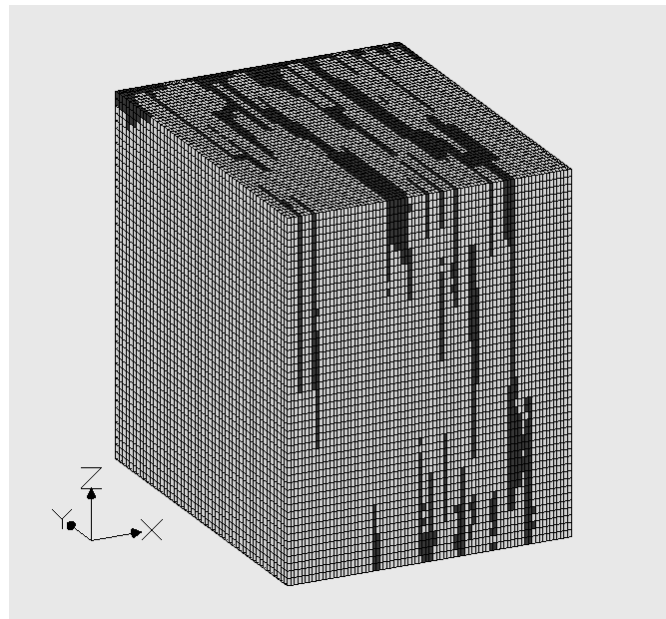

Fig. 2. An example of a 3D simulation. You will only be presented for 2D surface views.

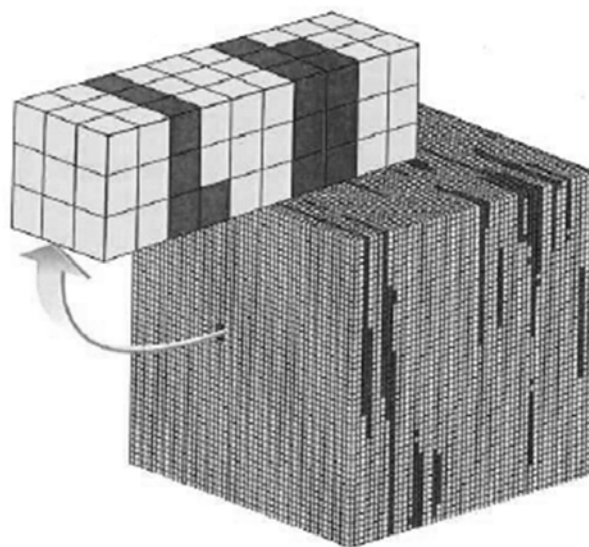

Fig. 3. The virtual tunnel will be drilled through the centre of the simulation. (Zetterlund, 2009)

References

Bedford, T. and Cooke, R., 2001, Probabilistic Risk Analysis: Foundations and methods: Cambridge University Press.

Danielsen, B. E., 2007, The applicability of geoelectrical imaging as a tool for construction in rock. Engineering Geology, Lund University, Sweden.

Freeze, R. A., James, B., Massmann, J., Sperling, T., and Smith, L., 1992, Hydrogeological Decision Analysis: 4. The Concept of Data Worth and Its Use in the Development of Site Investigation Strategies: Ground Water, **30**, 574-588.

Zetterlund, M., 2009, Geological Characterisation and the Observational Method. Application of Value of Information Analysis. Department of Civil and Environmental Engineering, Chalmers University of Technology, Göteborg, Sweden.

Questionnaire

Please read the document *Background to the questionnaire* before you answer the questions.

- 1) Do you have experience with pre-investigation for construction in rock (e.g. tunnels)?
- 2) Which geophysical method(s) are you familiar with?
- 3) Do you have experience with the method(s) used in hard rock environments?
- 4) Which method(s) would you use in the particular geological environment (described in the background material)?
- 5) How would you recommend the measurement setup/field campaign should be?
- 6) In the following a surface view of 10 simulations of the rock mass is shown. For the different simulations how many of the problematic zones would you expect the geophysical method(s) could detect?

Simulation 1

Number of zones detected:

Comments:

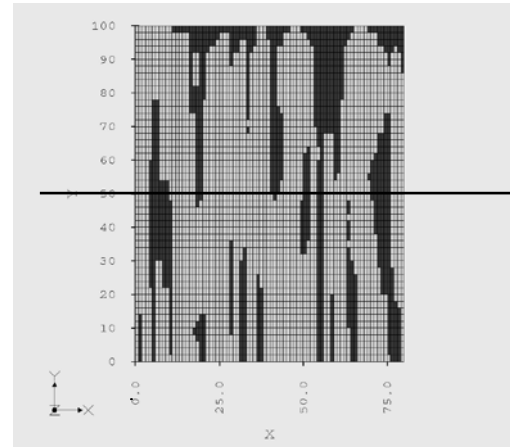

Simulation 2

Number of zones detected:

Comments:

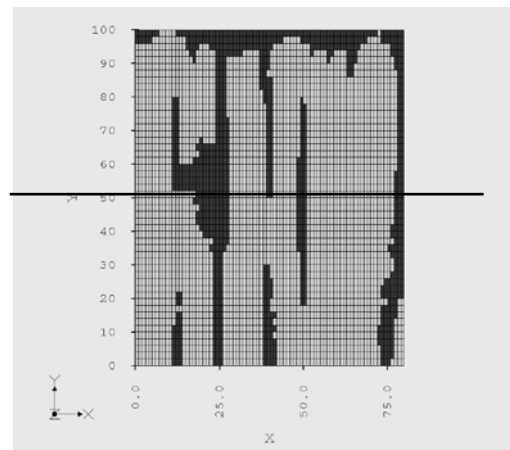

Simulation 3

Number of zones detected:

Comments:

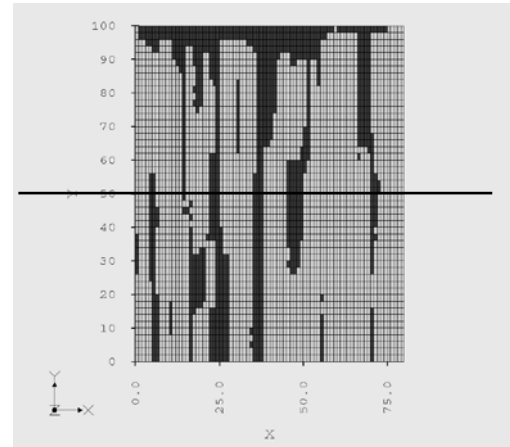

Simulation 4

Number of zones detected:

Comments:

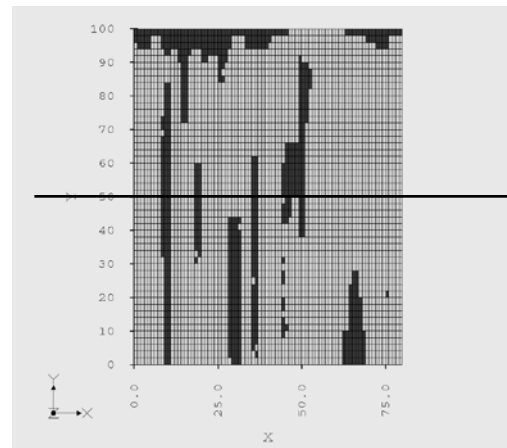

Simulation 5

Number of zones detected:

Comments:

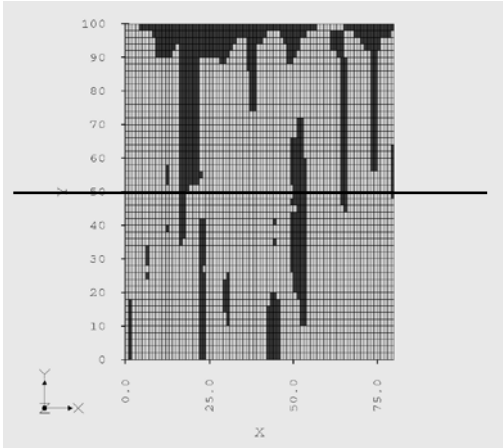

Simulation 6

Number of zones detected:

Comments:

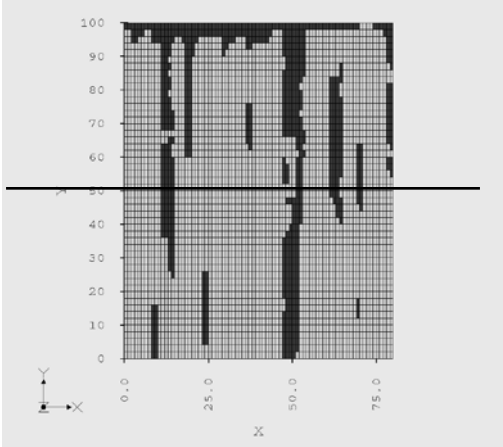

Simulation 7

Number of zones detected:

Comments:

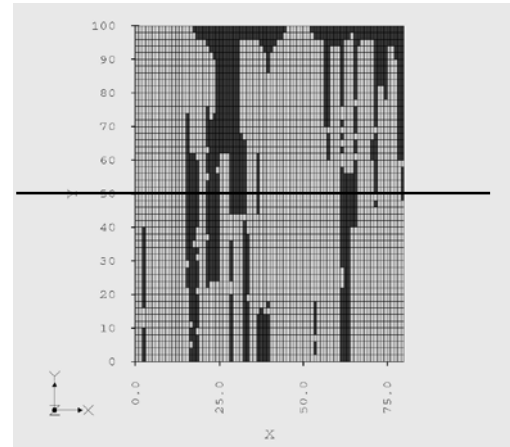

Simulation 8

Number of zones detected:

Comments:

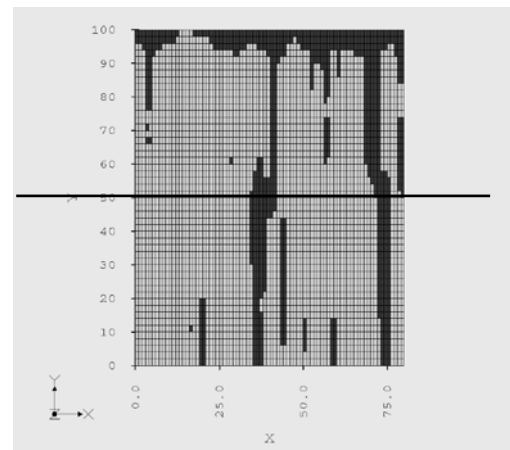

Simulation 9

Number of zones detected:

Comments:

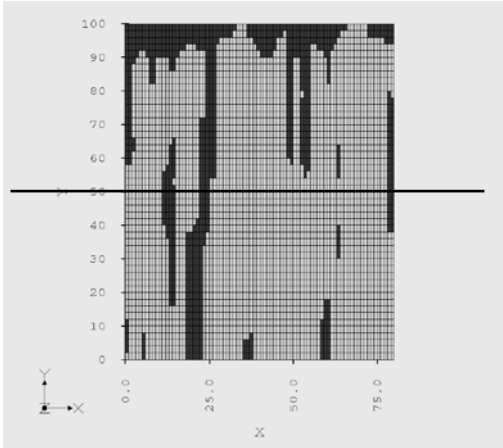

Simulation 10

Number of zones detected:

Comments:

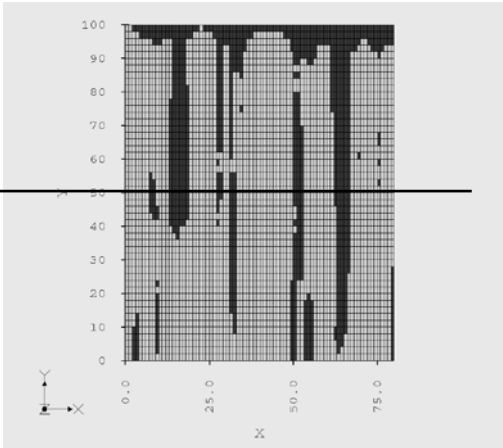

Appendix B

Cost and Calculations

Description of 6 reinforcement types (BFK1-BFK5) commonly used in Sweden:

Tabell 3: Använda utföranden i de olika bergförstärkningsklasserna.

Benämning	Tak	Vägg	Användning
BFK 1 (Q > 10)	Selektiv bultning, L=3.0 m 50 mm vidhäftande fiberarmerad sprutbetong	Selektiv bultning, L=3.0 m, (Vid behov 50 mm vidhäftande sprutbetong)	Tak/ vägg*
BFK 2 (Q = 4 – 10)	50 mm, vidhäftande fiberarmerad sprutbetong Systembultning c/c 2.0 m, L = 3.0 m	50 mm, vidhäftande sprutbetong Systembultning c/c 2.0 m, L = 3.0 m	Vidhäftning anses föreligga
BFK 3 c (Q = 1 – 4)	80 mm bergförankrad** fiberarmerad sprutbetong. c/c 1.7 m, L=3.0 m	50 mm bergförankrad** sprutbetong, c/c 2.0 m, L= 3.0 m	Där vidhäftning mot berg ej anses föreligga
BFK 3 d (Q = 1 – 0,1)	80 mm bergförankrad** fiberarmerad sprutbetong, c/c 1.5 m, L = 3.0 m	50 mm bergförankrad** fiberarmerad sprutbetong, c/c 1.5 m, L = 3.0 m	Där vidhäftning mot berg ej anses föreligga
BFK 4 (Q = < 0,1)	120 mm sprutat valv med fiberarmerad sprutbetong ned till väl rensad botten, förankring i vägg med 4 rader bult** från RÖK, c/c 1.3 m, L= 3.0 m		Dimensioneras efter mäktighet på bergtäckning eller bedömd löskäma. Användes vid låg bergtäckning, hög vattenföring, lerzon, o.d. Ev. modulerings-sprutning Bultförankring av konvexa bergpartier Valv *
BFK 5 (Q < 0,1)	120 mm bergförankrad fiberarmerad sprutbetong**, c/c 1.5 m, L = 3 – 4 m	100 mm bergförankrad sprutbetong**, c/c 1.5 m, L= 3 - 4 m	Tak/vägg*
BFK 6 - 10	Tyngre bergförstärkningar och specialförstärkningar hanteras som GK 3 fall.		

From Malmtorp and Lundman (2010)

Cost for 6 different reinforcement type commonly used in Sweden:

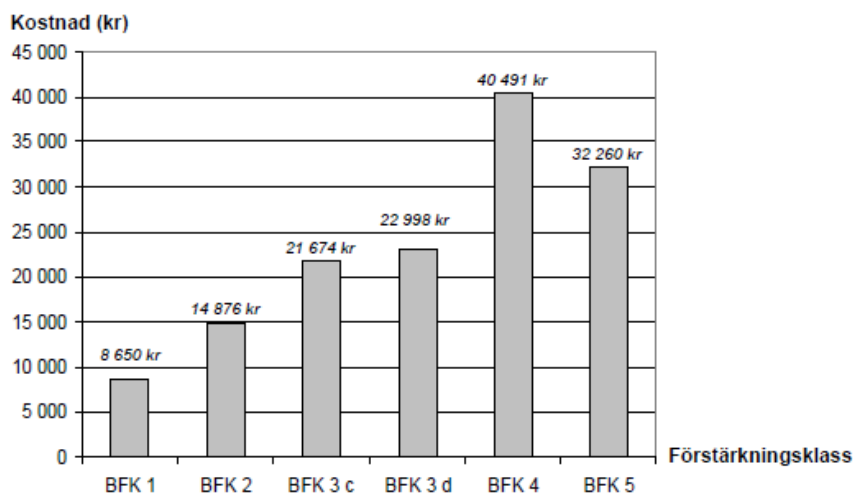

Figur 5-23: Jämförelse kostnader för slutförstärkning olika BFK. Priserna avser 2008 års prisnivå med januari som basmånad.

From Malmtorp and Lundman (2010)

The cost for the pre-investigation *alternative 1 (only drillings)*:

Method	Length (800 metre tunnel)	Price kSEK
Core drilling	2x50 metre	280
Sum		280
All drillings are incl. mob/demob		

The cost for the pre-investigation *alternative 2 (geophysics + drilling)*:

Method	Length (800 metre tunnel)	Price kSEK
Magnetics	4000	20
CVES	1600	90
Core drilling	2x50 metre	280
Sum, C_{preinv}		390
All drillings are incl. mob/demob		

The calculations are based on information from Mats Svensson (Tyréns), Hans Jeppsson (WSP) and Leif Bjelm (Lund University). The pre-investigation is planned based on the expert's opinion from the questionnaire.

Calculation of construction cost (materials):

The cost, C, for constructing the tunnel are based on the costs from Malmtorp and Lundman (2010). In this case the good rock (RC1) is reinforced with BFK1 (8650 sek/m) and the poor rock (RC2) is reinforced with BFK3b (22998 sek/m). The tunnel is 800 metre long and is divided into 100 sections of 8 metre (10 simulations).

$$C_1 = 90 * 86500 \text{ kr} + 10 * 229980 \text{ kr} = 10084.8 \text{ kSEK}$$

$$C_2 = 60 * 86500 \text{ kr} + 40 * 229980 \text{ kr} = 14389.2 \text{ kSEK}$$

Alternative 1 is assumed to be the null alternative, so the calculations C_1 is null and C_2 is the difference 4304.4 kSEK.

Calculation of the switchover cost (part of benefit):

In Malmtorp and Lundman (2010) and Kim and Bruland (2009) it is estimated that it takes 50% longer time to construct a tunnel if the BFK 3 is used instead of BFK 1. This is only time and not cost for more expensive reinforcement. Therefore **assumption**: The switchover cost is estimated to 50% higher when the switchover is unexpected. According to the head of construction (J. Sjöberg, Trafikverket) the real tunnel cost 131 kSEK/m. For 800 m tunnel that is 104800 kSEK.

Planned reinforcements cost 13000 kSEK incl. materials (in real tunnel).

(without any materials):

$$100\%: 104800 \text{ kSEK} - 13000 \text{ kSEK} = 91800 \text{ kSEK}$$

150%: 91800 kSEK + 50% = 137700 kSEK

There are 100 sections of 8 metre:

100%: 918 kSEK /section (cost if prepared for rock class)

150%: 1377 kSEK /section (cost if unprepared for rock class)

The switchover cost is said to be 50% higher (459 kSEK /section).

Calculation of cost if failure, C_F :

The prior (based on surface view only) analysis of the 100 sections shows that $P(F)$ is 0.5 (50% is RC2) and $P(F')$ is 0.5 (50% is RC1).

In alternative 1 the tunnel is build assuming that here is 10% RC2 and 90% RC1, thus there are 40 sections where the crew is unprepared and 60 sections where the crew is prepared, i.e. cost if failure, C_{F1} , is $(40 \cdot 1377 \text{ kSEK} + 60 \cdot 918 \text{ kSEK}) = 110160 \text{ kSEK}$.

In alternative 2 here are 10 sections where the crew is unprepared and 90 sections where the crew is prepared, i.e. cost if failure, C_{F2} , is $(10 \cdot 1377 \text{ kSEK} + 90 \cdot 918 \text{ kSEK}) = 96390 \text{ kSEK}$.

The switchover cost is decreased in alternative 2 and is: $C_{\text{switch}} = C_{F1} - C_{F2} = 13770 \text{ kSEK}$

Calculation of risk:

Risk is calculated as $R = P(F) C_{\text{switch}}$

$R_1 = 0.5 \cdot 13770 \text{ kSEK} = 6885 \text{ kSEK}$, i.e. unprepared in 40 out of 100 sections

$R_2 = R_1/4 = 1721.25 \text{ kSEK}$, i.e. unprepared in 10 out of 100 sections

Calculation of benefit:

Benefit is calculated as: $B_i = (R_0 - R_i)$

Benefit in alt 2 is the risk reduction.

$B_1 = 0 \text{ sek}$

$B_2 = R_1 - R_2 = 6885 \text{ kSEK} - 1721.25 \text{ kSEK} = 5163.75 \text{ kSEK}$

Calculation of prior objective function:

The objective function is calculated as $\phi_i = B_i - C_i$

$\phi_{1\text{prior}} = 0 \text{ SEK}$

$\phi_{2\text{prior}} = 5163.75 \text{ kSEK} - 4304 \text{ kSEK} = 859.75 \text{ kSEK}$

$\phi_{\text{prior}} = \max(\phi_{1\text{prior}}, \phi_{2\text{prior}}) = \max(0, 859.75 \text{ kSEK}) = 859.75 \text{ kSEK}$

Calculation of preposterior analysis:

The probabilities for detecting (and not detecting) failure are based on the 10 simulations (10x10 sections). The probability for detecting failure is different with or without geophysics.

$$P(D) = P(F)P(D | F) + P(F')P(D | F')$$

$$P(D') = 1 - P(D)$$

Bayes formula:

$$P(F | D) = P(F)P(D | F)/P(D)$$

$$P(F | D') = P(F)P(D' | F)/P(D')$$

The value of the preposterior analysis is calculated as

$$\phi_{\text{prepost}} = \max(0, C_{\text{switch}}P(F | D') - C_i)P(D') + \max(0, C_{\text{switch}}P(F | D) - C_i)P(D)$$

Only drillings:

$$\phi_{\text{prepost}} = \max(0, 13770 \text{ kSEK} * 0.450 - 4304.4 \text{ kSEK}) * 0.667 + \max(0, 13770 \text{ kSEK} * 0.600 - 4304.4 \text{ kSEK}) * 0.333$$

$$= 1892.1 * 0.667 + 3957.6 * 0.333 = 2580.6 \text{ kSEK}$$

Geophysics + drilling:

$$\phi_{\text{prepost}} = \max(0, 13770 \text{ kSEK} * 0.252 - 4304.4 \text{ kSEK}) * 0.646 + \max(0, 13770 \text{ kSEK} * 0.953 - 4304.4 \text{ kSEK}) * 0.354$$

$$= 0 * 0.646 + 8777.1 * 0.354 = 3122.9 \text{ kSEK}$$

Value of perfect information, EVPI:

$$P(D' | F) = P(D | F') = 0$$

$$P(F | D) = 1 \text{ and } P(F | D') = 0$$

$$P(D) = P(F) = 0.5 \text{ and } P(D') = 0.5$$

$$\phi_{\text{prepost EVPI}} = \max(0, 13770 \text{ kSEK} * 0 - 4304.4 \text{ kSEK}) * 0.5 + \max(0, 13770 \text{ kSEK} * 1 - 4304.4 \text{ kSEK}) * 0.5$$

$$= 0 * 0.5 + 9465.6 * 0.5 = 4732.8 \text{ kSEK}$$

Expected values of the information gained, EVI:

$$\text{EVI} = \phi_{\text{prepost}} - \phi_{\text{prior}}$$

Only drillings:

$$\text{EVI}_{\text{drill}} = 2580.6 \text{ kSEK} - 859.75 \text{ kSEK} = 1720.85 \text{ kSEK}$$

Geophysics + drilling:

$$EVI_{\text{geophysics}} = 3122.9 \text{ kSEK} - 859.75 \text{ kSEK} = 2253.15 \text{ kSEK}$$

With perfect information (EVPI):

$$EVI_{\text{perfect}} = 4732.8 \text{ kSEK} - 859.75 \text{ kSEK} = 3873.05 \text{ kSEK}$$

Expected Net Value, ENV:

$$ENV = EVI - C_{\text{preinv}}$$

Without geophysics:

$$ENV_{\text{drill}} = 1720.85 \text{ kSEK} - 280 \text{ kSEK} = 1440.85 \text{ kSEK}$$

With geophysics:

$$ENV_{\text{geophysics}} = 2253.15 \text{ kSEK} - 390 \text{ kSEK} = 1863.15 \text{ kSEK}$$